



**Stantec Consulting Ltd.**  
1-70 Southgate Drive, Guelph ON N1G 4P5

February 17, 2017  
File: 160961067

**Attention: Emma Valliant, A/Regional Planning Ecologist**

Ministry of Natural Resources and Forestry  
Peterborough, Ontario  
Email: Emma.Valliant@ontario.ca

Dear Ms. Valliant,

**Reference: Adelaide Wind Power Project: Year 1 Post-Construction Wildlife Monitoring Report (2015)**

Thank you for your comments on the Adelaide Wind Power Project: Year 1 Post-Construction Wildlife Monitoring Report (PCMR, Stantec 2016). We have updated the 2015 report with the suggested edits and have included our responses below.

Comments were received from the Ministry of Natural Resources and Forestry (MNRF) on the proposed raptor cause and effect monitoring program, as detailed in the Adelaide Wind Power Project: Raptor Monitoring Plan (Appendix I of the PCMR), via email on June 1, 2016. A response was provided by Stantec Consulting Ltd. on June 21, 2016, which clarified protocols proposed for the 2016 raptor cause and effect monitoring program. The proposed program was approved by the MNRF on June 23, 2016.

Additional comments were received from the MNRF on the PCMR, imbedded within the report on June 23, 2016.

Please find our responses to the comments provided on the PCMR (including the Raptor Monitoring Plan) summarized in the Table below.



**Reference: Adelaide Wind Power Project: Year 1 Post-Construction Wildlife Monitoring Report (2015)**

**Raptor Monitoring Plan (Appendix I), comments received via email on June 21, 2016 and response sent June 21, 2016**

Comment	Stantec Response	Reference
<p>One additional raptor, an Osprey, was recovered during the supplemental monthly monitoring program.            Comment: Field notes and email indicate that this was found during the monthly raptor monitoring in June. Please include this mortality in the corrected mortality estimate for raptors. The rest of the report will also need to be revised.</p>	<p>Carcasses found during the monthly raptor surveys at non-subset turbines are typically not included in the correction calculation. In part, because the non-subset turbines do not have associated correction factors (e.g. Ps). The correction calculation takes non-subset turbine into account when determining annual mortality rates.</p>	<p>1.0 Introduction            Raptor Monitoring Plan (Appendix I)</p>
<p>Monitoring at the non-subset turbines should be increased to weekly for May-July (instead of twice per month).</p>	<p>Stantec increased the monitoring at non-subset turbines from once every two weeks to once weekly. The Raptor Monitoring Protocol has been revised accordingly.            For 2016, the increase frequency to once weekly started first week of June (i.e. week starting June 6).</p>	<p>3.1 Scoped Mortality Monitoring            Raptor Monitoring Plan (Appendix I)</p>
<p>Scavenger removal trials should be conducted to determine if any raptors are being removed by scavengers.</p>	<p>Please note the cause and effect monitoring does not include a correction calculation and that the annual mortality rates for raptors continue to be calculated through the regular EEMP monitoring. The purpose of the cause and effect monitoring is to provide a comprehensive spatial distribution of raptor fatality, which can be compared to the habitat mapping, to assess habitat based risk factors. Additionally, carcasses persistence of raptor is generally very high. As such, we would expect any scavenging over the one-week search interval to be very minimal.            Regardless, Stantec included raptor carcasses in the EEMP scavenger trials to confirm if raptor scavenging is occurring. We will aim to use up to three raptor carcasses each year. However, given raptor carcasses in suitable conditions are limited, the number of raptors in the scavenger trials may be less than three.            The Raptor Monitoring Protocol has been revised accordingly.</p>	<p>3.2 Cause and Effect Monitoring            Raptor Monitoring Plan (Appendix I)</p>
<p>Please include behavioural monitoring. Visual monitoring of the raptors should be done to try to determine what their behaviour is and how the turbines can be mitigated appropriately.</p>	<p>Behavioural surveys have been added to the protocol, with weekly surveys in May, June, and July. The surveys monitored active nests, with notes being made on activity of the nest and observations of raptor movements and behaviour. Each behaviour observed (and duration of time spent per behaviour) and flight heights will be recorded. Each flight path observed and any perches used were identified and mapped in relation to turbine locations.            The results of the surveys were used to identify raptor behavior in proximity to wind turbines including flight patterns, flight heights and identify perching and foraging habitat.            The Raptor Monitoring Protocol has been revised accordingly.            For 2016, the behavioral surveys started the first week of June (i.e. week starting June 6).</p>	<p>3.2 Cause and Effect Monitoring            Raptor Monitoring Plan (Appendix I)</p>
<p>3.2.1 Background Review            To clarify, are you essentially doing a records review for the time period since construction started until now?</p>	<p>Correct. The NHA (including the Record Review) was authored in 2012. The intent of the background review is to complete a more current review of records. The background review will focus on sources that may include information regarding raptor nests, such as ebirds, which was not part of the original NHA Records Review. Note that ebirds maps species occurrences, that do not necessarily reflect nesting locations.            However, a review of occurrence date and location can provide potential nest site that can be confirmed through the field surveys.</p>	<p>3.2 Cause and Effect Monitoring            Raptor Monitoring Plan (Appendix I)</p>
<p><b>Post-Construction Wildlife Monitoring Plan, comments embedded in document (June 21, 2016)</b></p>		
<p>Carcasses should be discretely marked (e.g., clipping of ear, wing, leg, fur, hole-punching ear). Orange tape and thread are highly visible to the searcher.            Marking: Carcasses should be discretely marked for trials.</p>	<p>All carcasses markings were placed underneath the carcass. At no time were tags or tape or thread visible to the searcher while conducting their surveys. Section 2.1.3.1 was updated accordingly.</p>	<p>2.1.3.1 Searcher Efficiency Trials            PCMP            Table F5: Searcher Efficiency            Appendix F</p>



**Reference: Adelaide Wind Power Project: Year 1 Post-Construction Wildlife Monitoring Report (2015)**

Comment	Stantec Response	Reference
Please include the raw data for AC. Searcher efficiency data is missing for AC.	Based on established searcher efficiency trial parameters (i.e., 3 maximum carcass deployments per trial, 20 carcasses per season) there was not an opportunity to conduct adequate searcher efficiency trials on AC during her 4 survey dates in 2015. As such, seasonal searcher rates were imported from another wind facility where adequate searcher trials were conducted. Raw data is now included in Appendix F for AC.	Table 3.1: Searcher Efficiency Appendix E Table F5: Searcher Efficiency Appendix F
Trials should consist of 1/3 bat carcasses.	Bats were used for 28 % (17 of 60) scavenger trial carcasses. This is one bat carcass less, and therefore within the range, of the required 1/3 (33%; 18 of 60). Bird carcasses are available from an external source for these trials but bats carcasses, to the best of our knowledge, are not. Due to this being the first year of mortality monitoring bat carcasses were limited.	Table 3.3: Scavenger Trials Appendix E
There are a few comments in the raw data. It appears that some of the turbines have their drawings flipped? And there seems to be a few months missing? Please include all turbine drawings.	All turbine drawings were included. See below for responses to specific inquires.	Table 3.4: Percent Searched Appendix E
July Ps: Should this be 0.78? 0.775 rounds up to 0.78.	The numbers for the percent area searched per turbine per month were taken from excel calculations which carry additional decimal places, and are therefore more accurate. We realize this rounding error, however we did not update our numbers during this submission due to the greater accuracy employed by carrying the additional decimal places as well as a lack of impact on corrected mortality rates resulting from a 0.01 change. We will ensure we round appropriately in 2016.	Table 3.4: Percent Searched Appendix E
August Ps: Should this be 0.79? 0.789 rounds up to 0.79.	See note above.	Table 3.4: Percent Searched Appendix E
October Ps: Should this be 0.92?	See note above.	Table 3.4: Percent Searched Appendix E
C total: How did you get this number?	Have corrected Table 3.6 and the associated text in the PCMR and Raptor Monitoring Protocol. C= 4.60 C/Turbine= 0.46 C/MW=0.21	Table 3.6: Corrected Raptor Mortality Estimate Appendix E Appendix I
Turbines 6, 7, 12, 19, 22 Visit 1: Should these be 8?	Trial check is July, and as such have been updated to 7. Appendix F7 has been updated.	Table F7: Scavenger Trials Appendix F
May 4, 2015 Carcass Search Area Grid: Is this turbine 11? Drawing is different in subsequent months.	"N" has been changed to "S," as the searcher was facing south during some of these drawings instead of north as indicated.	Appendix G1
July 13, 2015 Carcass Search Area Turbine 12: This one is drawn different too.	See note above.	Appendix G1
July 16, 2015 Carcass Search Area Turbine 12: Flipped again.	See note above.	Appendix G1
May 4, 2015: Is this the only map for T20?	Field staff created only one map. Only one day (August 27, 2015), the turbine had a reduced search area (5267m <sup>2</sup> ), so a new map was not created.	Appendix G1
October 26, 2015 Turbine 22: Is there a map for Aug. and Sept?	Search area at turbine 22 did not vary drastically through August and September, so no new map was created.	Appendix G1
Please insert updated raptor monitoring protocol from email dated June 17, 2016. Please edit any sections in the report to reflect the updated protocol (e.g., exec summary, summary and recommendations).	The updated Raptor Monitoring Protocol is included in this submission, with detailed responses provided in the first section of this table.	Appendix I



February 17, 2017  
Emma Valliant, A/Regional Planning Ecologist  
Page 4 of 4

**Reference: Adelaide Wind Power Project: Year 1 Post-Construction Wildlife Monitoring Report (2015)**

Please contact the undersigned if you have any additional questions.

Regards,

**STANTEC CONSULTING LTD.**

*Melissa Straus*  
Melissa Straus, M.Sc.  
Terrestrial Ecologist  
Phone: (519) 780-8103  
Fax: (519) 836-2493  
Melissa.Straus@stantec.com

*Andrew Taylor*  
Andrew Taylor  
Senior Ecologist  
Phone: (519) 780-8122  
Fax: (519) 836-2493  
Andrew.Taylor@stantec.com

Attachment: Adelaide Wind Power Project: Year 1 Post-Construction Wildlife Monitoring Report  
(2015) - Final

c. Mark Kozak, Suncor Energy  
Gavin Lowe, Suncor Energy

rt \\cd1220-f02\01609\active\60961067\reports\post-construction annual reports\2015\20161215\_fnl\0\_et\_61067\_adelaide\_pcm\_comment\_response.docx

**Adelaide Wind Power Project:  
Year 1 Post-Construction  
Wildlife Monitoring Report  
(2015)**



Prepared for:  
Suncor Adelaide Wind Limited  
Partnership  
150 6<sup>th</sup> Avenue SW  
Calgary AB T2P 3E3

Prepared by:  
Stantec Consulting Ltd.  
70 Southgate Drive, Suite 1  
Guelph ON N1E 7B8

File No. 160961067  
February 17, 2017

## Sign-off Sheet

This document entitled Adelaide Wind Power Project: Year 1 Post-Construction Wildlife Monitoring Report (2015) was prepared by Stantec Consulting Ltd. ("Stantec") for the account of Suncor Energy Products Inc. (Suncor) (the "Client"). Any reliance on this document by any third party is strictly prohibited. The material in this document reflects Stantec's professional judgment in light of the scope, schedule and other limitations stated in the document and in the contract between Stantec and the Client. The opinions in the document are based on conditions and information existing at the time the document was published and do not take into account any subsequent changes. In preparing the document, Stantec did not verify information supplied to it by others. Any use which a third party makes of this document is the responsibility of such third party. Such third party agrees that Stantec shall not be responsible for costs or damages of any kind, if any, suffered by it or any other third party as a result of decisions made or actions taken based on this document.

Prepared by \_\_\_\_\_ Melissa Straus  
(signature)

**Melissa Straus, M.Sc.**  
Terrestrial Ecologist

Reviewed by \_\_\_\_\_ Andrew Taylor  
(signature)

**Andrew Taylor, B.Sc.**  
Senior Ecologist

Reviewed by \_\_\_\_\_ N. Kopysh  
(signature)

**Nicole Kopysh, B.E.S.**  
Project Manager

## Table of Contents

<b>EXECUTIVE SUMMARY</b> .....	<b>I</b>
<b>ABBREVIATIONS</b> .....	<b>V</b>
<b>1.0 INTRODUCTION</b> .....	<b>1.1</b>
1.1 PROJECT OVERVIEW.....	1.1
1.2 ENVIRONMENTAL EFFECTS MONITORING PROGRAM .....	1.1
1.3 PREVIOUS MONITORING PROGRAMS.....	1.2
<b>2.0 METHODOLOGY</b> .....	<b>2.1</b>
2.1 MORTALITY MONITORING .....	2.1
2.1.1 Weekly Mortality Monitoring .....	2.2
2.1.2 Raptor Mortality Monitoring .....	2.3
2.1.3 Correction Factors.....	2.3
2.1.4 Estimate of Mortality.....	2.7
2.2 DISTURBANCE EFFECTS MONITORING: AMPHIBIAN BREEDING HABITAT .....	2.8
<b>3.0 RESULTS</b> .....	<b>3.1</b>
3.1 MORTALITY MONITORING .....	3.1
3.1.1 Searcher Efficiency Trials .....	3.1
3.1.2 Scavenger Trials .....	3.1
3.1.3 Proportion of Area Searched.....	3.2
3.1.4 Mortality .....	3.2
3.1.5 Notifications.....	3.5
3.1.6 Summary .....	3.5
3.2 DISTURBANCE EFFECTS MONITORING: BREEDING AMPHIBIANS .....	3.6
<b>4.0 DISCUSSION</b> .....	<b>4.1</b>
4.1 MORTALITY MONITORING .....	4.1
4.1.1 Searcher Efficiency Trials .....	4.1
4.1.2 Scavenger Trials .....	4.1
4.1.3 Proportion of Area Searched.....	4.1
4.1.4 Bird Mortality.....	4.2
4.1.5 Bat Mortality .....	4.6
4.2 DISTURBANCE EFFECTS MONITORING: BREEDING AMPHIBIANS .....	4.7
<b>5.0 SUMMARY AND RECOMMENDATIONS</b> .....	<b>5.1</b>
<b>6.0 REFERENCES</b> .....	<b>6.1</b>

**LIST OF APPENDICES**

**APPENDIX A FIGURES**

**APPENDIX B ENVIRONMENTAL EFFECTS MONITORING PLAN**

**APPENDIX C: RENEWAL ENERGY ACT APPROVAL**

**APPENDIX D TURBINE SELECTION CORRESPONDENCE**

**APPENDIX E TABLES**

**APPENDIX F: RAW MORTALITY DATA**

**APPENDIX G: FIELD FORMS**

Appendix G1 Field Forms (Mortality Monitoring)

Appendix G2 Field Forms (Disturbance Monitoring)

**APPENDIX H: NOTIFICATIONS**

**APPENDIX I: RAPTOR MONITORING PROTOCOL**



**LIST OF FIGURES – APPENDIX A**

- Figure 1: Mortality Monitoring Subset
- Figure 2: Amphibian Monitoring Stations
- Figure 3: Fatalities at the Adelaide Wind Energy Project by Date, 2015
- Figure 4: Fatalities at the Adelaide Wind Energy Project by Turbine, 2015

**LIST OF TABLES – APPENDIX E**

Table 2.1:	Categories of Carcass Condition.....	E.1
Table 2.2:	Categories of Visibility Class.....	E.1
Table 2.3:	Adelaide Wind Energy Project Disturbance Monitoring Field Survey Record, 2015 .....	E.1
Table 3.1:	Searcher Efficiency Trials at the Adelaide Wind Energy Project, 2015....	E.2
Table 3.2:	Weighted Search Efficiencies at the Adelaide Wind Energy Project, 2015 .....	E.2
Table 3.3:	Scavenger Trials at the Adelaide Wind Energy Project, 2015 .....	E.2
Table 3.4:	Average Monthly Percent Area Searched (Ps) at the Adelaide Wind Energy Project, 2015.....	E.3
Table 3.4:	Average Monthly Percent Area Searched (Ps) at the Adelaide Wind Energy Project, 2015.....	E.4
Table 3.6:	Corrected Monthly Raptor Mortality Estimates at the Adelaide Wind Energy Project, 2015.....	E.5
Table 3.7:	Supplemental Monitoring and Incidental Fatalities at the Adelaide Wind Energy Project, 2015.....	E.6
Table 3.8:	Uncorrected Monthly Small Bird Fatalities at the Adelaide Wind Energy Project, 2015 .....	E.6
Table 3.9:	Small Bird Fatalities per Turbine at the Adelaide Wind Energy Project, 2015 .....	E.7
Table 3.10:	Corrected Monthly Small Bird Mortality Estimates at the Adelaide Wind Energy Project, 2015.....	E.7
Table 3.11:	Uncorrected Monthly Bat Fatalities at the Adelaide Wind Energy Project, 2015 .....	E.8
Table 3.12:	Uncorrected Bat Fatalities by Turbine at the Adelaide Wind Energy Project, 2015.....	E.8
Table 3.13:	Corrected Bat Mortality Estimates at the Adelaide Wind Energy Project, 2015 .....	E.9
Table 3.14:	Amphibian Survey: Maximum Call-count Code Results .....	E.11

## **Executive Summary**

Suncor Adelaide Wind Limited Partnership (Suncor) is operating the Adelaide Wind Power Project (Adelaide) north of Strathroy, Ontario, in the Municipality of Adelaide Metcalfe in Middlesex County. The 40 megawatt facility includes 18 wind turbines, associated access roads, meteorological tower, underground collector lines, and a substation. Adelaide became fully operational on January 29, 2015.

The Renewable Energy Approval (REA) for Adelaide was issued on December 11, 2013 under the *Environmental Protection Act* section 47.3(1) (REA No. 8279-9AUP2B). Section I of the REA includes the post-construction monitoring requirements for the facility, including reporting requirements, and applicable performance measures (i.e. mortality thresholds).

An Environmental Effects Monitoring Plan for Wildlife and Wildlife Habitat (EEMP) was prepared for Adelaide (Stantec 2012a). The EEMP details the wildlife and wildlife habitat monitoring program, which includes both pre-construction habitat use studies as well as the post-construction monitoring program. In considering both the EEMP and Section I of the REA, the Adelaide post-construction wildlife and wildlife habitat monitoring program for the first year of operation included the following components:

- mortality monitoring for birds, bats and raptors
- disturbance monitoring for breeding amphibians

2015 was the first year of the post-construction monitoring program for wildlife at Adelaide. The results of this first year of monitoring are presented in this report.

Post-construction mortality monitoring was conducted for bats, birds and raptors using standard methodologies for mortality surveys, in accordance with *Bats and Bat Habitats: Guidelines for Wind Power Projects* (Ministry of Natural Resources [MNR] 2011a) and *Birds and Bird Habitats: Guidelines for Wind Power Projects* (MNR, 2011b). Bi-weekly searches were conducted at 10 turbines from May- October, with monthly searches at all turbines for raptors (May-November). Weekly monitoring at the same 10 turbine subset for raptors occurred through November.

Fatalities recorded during the May- October bi-weekly mortality monitoring program included 4 raptor fatalities (2 species), 10 bird fatalities (6 species) and 36 bat fatalities (4 species). No species at risk were recovered during the bi-weekly monitoring program in 2015.

## ADELAIDE WIND POWER PROJECT: YEAR 1 POST-CONSTRUCTION WILDLIFE MONITORING REPORT (2015)

Correcting for searcher efficiency, scavenger removal, and percent area searched, the following mortality rates were recorded at the Adelaide Wind Energy Project during the first year of monitoring:

- 0.46 raptors/turbine/year
- 0 provincially tracked raptors/turbine/year
- 2.32 small birds/turbine/year across the wind power project
  - range of 0 – 6.93 birds/turbine at individual turbines
- 8.57 bats/turbine/year

The maximum bird mortality during a single mortality monitoring survey was:

- 2 birds at any one turbine
- 2 birds (including raptors) at multiple turbines

The recorded mortality rates at Adelaide in 2015 do not exceed thresholds detailed in Section 15 of the REA for small birds, tracked raptors, or bats. However, the observed raptor mortality rate of 0.46 raptors/turbine/year exceeds the 0.2 raptors/turbine/year established threshold (MNR 2011a, 2011b; REA Section 15), resulting from four raptor mortalities of two species recovered in June. Red-tailed Hawk (*Buteo jamaicensis*) and Turkey Vulture (*Cathartes aura*) are both ranked S5 (Secure) in the province. Observed raptor fatality rates at Adelaide in 2015 were unusual, as all fatalities occurred within an eleven day period in June during the breeding season, when raptor mortality is typically very low.

Bat and small bird mortality rates in 2015 were within established thresholds, and well below the average rates in Ontario. The exceedance of the raptor threshold during the first year of monitoring requires two years of scoped mortality and cause and effect monitoring as detailed in REA Section 18. Stantec recommends that these additional monitoring requirements for raptors be met by increasing the frequency of monthly mortality monitoring during the breeding season and by conducting habitat use surveys.

Disturbance studies were comprised of amphibian call count surveys at features containing significant breeding habitat (woodland and wetland) located within 120 m of Project components (e.g., substation, turbines, or access roads).

Six species were recorded during amphibian call count surveys conducted in 2015: spring peeper, western chorus frog, American toad, northern leopard frog, gray treefrog, and green frog. Compared to pre-construction surveys conducted in 2013, although there was some variation in call count survey results by station, all 3 features surveyed remained significant wildlife habitat for breeding amphibians post-construction as defined by the Draft Significant Wildlife Habitat Ecoregion 7E Criterion Schedule (MNR 2012).

## ADELAIDE WIND POWER PROJECT: YEAR 1 POST-CONSTRUCTION WILDLIFE MONITORING REPORT (2015)

Monitoring in 2016 (year 2) will provide a second year of data and include:

- mortality monitoring (raptors, birds and bats)
- supplemental monitoring for raptors in accordance with REA Section 18
  - scoped mortality monitoring: increasing the frequency of monthly raptor monitoring at non-subset turbines to twice a month (May-July)
  - cause and effect monitoring: background review (once) and twice annual habitat mapping of suitable nest and foraging habitat (April, mid-May/June)

Additional data from the subsequent years of mortality monitoring for the Adelaide Wind Power Project will be useful to further assess whether the results observed in the first year of operation (and monitoring) are representative of the facility over time.

Disturbance monitoring for amphibian breeding habitat in 2015 was completed in accordance with the EEMP (i.e., 1 year of post-construction monitoring) and found no significant impacts. No further monitoring is required in 2016 or 2017.

## Abbreviations

C	Corrected number of birds or bats
c	Raw number of birds or bats
CI	Confidence Interval
CWHC	Canadian Wildlife Health Cooperative
EEMP	Environmental Effects Monitoring Plan
GPS	Global Positioning System
KV	Kilovolt
MNRF/MNR	Ministry of Natural Resources and Forestry
MW	Megawatt
NHA/EIS	Natural Heritage Assessment and Environmental Impact Study
PIF	Partners In Flight
Ps	Percent area searched
REA	Renewable Energy Approval
SARA	Species at Risk Act
SARO	Species at Risk in Ontario
Sc	Scavenger rate
Se	Searcher Efficiency rate
T	Turbine

Introduction  
February 17, 2017

## 1.0 INTRODUCTION

### 1.1 PROJECT OVERVIEW

Suncor Adelaide Wind Limited Partnership (Suncor) is operating the Adelaide Wind Power Project (Adelaide) north of Strathroy, Ontario, in the Municipality of Adelaide Metcalfe in Middlesex County. The Project Area is bound by Sexton Road to the west, Townsend Line and Wardell Road to the North, Hansford Road to the east, and Highway 402 to the south. The 40 megawatt (MW) facility became fully operational on January 29, 2015 and is comprised of 18 wind turbines, associated access roads, meteorological tower, underground collector lines, and a substation (**Figure 1, Appendix A**).

The Renewable Energy Approval (REA) for Adelaide was issued on December 11, 2013 under the *Environmental Protection Act* section 47.3(1) (REA No. 8279-9AUP2B).

2015 was the first year Adelaide was fully operational and was the first year of the post-construction monitoring program for wildlife.

### 1.2 ENVIRONMENTAL EFFECTS MONITORING PROGRAM

An Environmental Effects Monitoring Plan for Wildlife and Wildlife Habitat (EEMP) (Stantec, 2012a) was prepared in compliance with O. Reg. 359/09, *Bats and Bat Habitats: Guidelines for Wind Power Projects* (Ministry of Natural Resources [MNR], 2011a) and *Birds and Bird Habitats: Guidelines for Wind Power Projects* (MNR, 2011b). The EEMP was approved by the Ministry of Natural Resources (MNR at the time, now Ministry of Natural Resources and Forestry (MNRF)) on July 21, 2012. The confirmation letter and EEMP for Adelaide is provided in **Appendix B**.

The purpose of the EEMP is to identify performance objectives to assess the effectiveness of the proposed mitigation measures and identify contingency measures that will be implemented if performance objectives cannot be met. A comprehensive monitoring program is required to verify the accuracy of the predicted operational impacts and address concerns regarding possible negative effects for wildlife.

In accordance with methods proposed in the EEMP and requirements of the MNRF in their confirmation letter (**Appendix B**), a pre-construction monitoring program was completed in 2013 to assess habitat use (i.e., significance) of waterfowl nesting, amphibian breeding, marsh bird breeding, and shrub/early successional bird breeding habitat. Results determined that only the amphibian breeding habitat in woodlands and wetlands met the criteria for significance. As such, disturbance monitoring amphibian breeding habitat (woodland and wetland) is included in the post-construction monitoring program and detailed in Section I3 of the REA (**Appendix C**).

# ADELAIDE WIND POWER PROJECT: YEAR 1 POST-CONSTRUCTION WILDLIFE MONITORING REPORT (2015)

Introduction  
February 17, 2017

In accordance with the EEMP and REA Section 13, the 2015 Adelaide Wind Power Project post-construction monitoring program included the following components:

- mortality monitoring for birds, bats and raptors
- disturbance monitoring for amphibian breeding habitat

Detailed performance objectives, mitigation and contingency measures for each monitoring component are provided in the EEMP (**Appendix B**). The EEMP provides thresholds for annual mortality rates of birds and bats, in accordance with the *Bats and Bat Habitats: Guidelines for Wind Power Projects* (MNR 2011a), and *Birds and Bird Habitats: Guidelines for Wind Power Projects* (MNR 2011b). The thresholds, as outlined in the EEMP and as included in the Adelaide REA (Section 15), are:

- 0.2 raptors/turbine/year (averaged across the Project)
- 0.1 provincially tracked raptors/turbine/year (averaged across the Project)
- 14 birds/turbine/year (at individual turbines or turbine groups)
- 10 bats/turbine/year (averaged across Project)

Or if bird mortality during a single mortality monitoring survey exceeds:

- 10 or more birds at any one turbine
- 33 or more birds (including raptors) at multiple turbines.

## 1.3 PREVIOUS MONITORING PROGRAMS

A Natural Heritage Assessment and Environmental Impact Study (NHA/EIS) were completed as part of the REA application in accordance with O. Reg. 359/09 (Stantec 2012b). The NHA/EIS was confirmed by the MNRF on July 31, 2012. One subsequent addendum to the NHA (Stantec, 2012c) was submitted and addressed modifications to the Project layout as it was presented in the original NHA in October 2012. MNRF confirmation was received on October 23, 2012 for Addendum 1. Two subsequent modification memos were submitted by Stantec in February, 2013 (Stantec, 2013a) and November, 2013 (Stantec, 2013b) to address changes in temporary construction staging areas and underground collector-line cable locations.

As a condition of approval, pre-construction studies for amphibians were completed in spring 2013. Three features were assessed as significant, as reported to MNRF on July 4, 2013; as such, these three features were included in the EEMP monitoring.



Methodology  
February 17, 2017

## 2.0 METHODOLOGY

Post-construction mortality monitoring was conducted for bats, birds and raptors. Standard methodologies for mortality surveys were used, in accordance with *Bats and Bat Habitats: Guidelines for Wind Power Projects* (MNR, 2011a), and *Birds and Bird Habitats: Guidelines for Wind Power Projects* (MNR, 2011b), as detailed in the EEMP (**Appendix B**).

The purpose of the mortality monitoring program is to identify the number of birds, bats and raptor fatalities on an annual per turbine basis, averaged across the Adelaide facility. An estimate of mortality is calculated based on the observed fatalities and adjusted for carcass removal, searcher efficiency and percent area searched.

The purpose of disturbance monitoring is to assess if potential indirect impacts, such as disturbance or avoidance, have occurred. Results are measured against pre-construction baseline data and used to determine whether contingency measures are required. This was done at Adelaide by conducting amphibian breeding surveys at features deemed significant by pre-construction surveys in 2013 and specified within the REA Section 13 (Amphibian breeding habitats 6, 16, and 20).

## 2.1 MORTALITY MONITORING

A mortality monitoring program, as per the EEMP and REA, was conducted at Adelaide from May through November, 2015. The mortality monitoring consisted of:

- weekly mortality monitoring:
  - monitoring at a subset of 10 turbines (>30 % of all turbines, minimum of 10)
  - twenty-six weeks of twice-weekly monitoring for bats, birds and raptors from the beginning of May to the end of October
- monthly monitoring of all turbines for raptor mortalities from May through November
- weekly monitoring for raptors at the 10 turbine subset through November
- correction factor trials:
  - searcher efficiency testing
  - scavenger trials
  - percent area searched



Methodology  
February 17, 2017

## 2.1.1 Weekly Mortality Monitoring

Turbines included in the subset were selected via a stratified random sample to provide representative coverage of the habitats and layout of the Project area. The selected turbine subset is shown on **Figure 1, Appendix A**, which was sent to the MNRF on April 22, 2015 (**Appendix D**) for approval. As the turbine subset provides a representative sample of the Project area and is in accordance with criteria outlined by the MNRF (e.g., >30 % of the total number of turbines is included in the subset at a minimum 10 turbines; MNR 2011a, 2011b) it is expected that in the absence of a response from the MNRF the turbine subset is suitable for the monitoring program and as such will represent the search subset for the three- year program.

Carcass searches were conducted at the subset of 10 turbines twice-weekly (i.e., at alternating three- and four-day intervals) for 26 weeks from the beginning of May through to the end of October for bats, birds and raptors. Searches continued weekly at the 10 turbine subset for four weeks through November for raptors. Carcass searches were conducted within minimally-vegetated portions (i.e., Visibility Classes 1 and 2 as per MNR, 2011a and 2011b) of a 50 m search area radius. Concentric circles spaced 5 to 6 m apart were walked, allowing for a visual search of 2.5 to 3 metres on each side of the observer. The 50 m search area radius and the radius of each concentric transects were determined using a Global Positioning System (GPS).

Weather parameters (temperature, wind speed and precipitation) were recorded on each day surveys were conducted. When a bird or bat carcass was discovered, the following information was recorded:

- searcher ID
- species
- turbine number
- date and time it was found
- sex (if possible to determine)
- forearm length (applicable only to bat fatalities)
- UTM coordinates
- state of decomposition (see **Table 2.1, Appendix E**)
- estimated days since death
- injury sustained (if applicable)
- distance and direction from the nearest turbine;
- substrate upon which the carcass was found
- visibility class (see **Table 2.2, Appendix E**)

Methodology  
February 17, 2017

Carcasses found in the field were photographed and collected for confirmation of species. For bat specimens, a measurement of forearm length was taken using a digital caliper to assist in species identification. Suitable carcasses (i.e., those in reasonable condition) were later used in searcher efficiency or scavenger trials, excluding species at risk (i.e., threatened or endangered federally or provincially).

## 2.1.2 Raptor Mortality Monitoring

For the purposes of this post-construction monitoring and reporting of results, “raptors” refers to Osprey (family Pandionidae), hawks and eagles (members of the family Accipitridae), falcons (members of the family Falconidae), and vultures (members of the family Cathartidae). Raptors determined to be of conservation concern by the MNRF Natural Heritage Information Center are described as tracked raptors, which in the province of Ontario include: Bald Eagle (*Haliaeetus leucocephalus*), Golden Eagle (*Aquila chrysaetos*), Rough-legged Hawk (*Buteo lagopus*), and Peregrine Falcon (*Falco peregrinus*).

In addition to the weekly mortality monitoring program, supplementary raptor mortality monitoring was conducted at the remaining 8 turbines that were not included in the regular mortality monitoring subset. Each turbine was searched once a month in May through November within 50 m of turbines by walking in concentric circles.

During the month of November, in the absence of the bi-weekly regular mortality monitoring, supplemental weekly surveys at the 10 turbine subset were conducted as described above. The frequency of these surveys are conducted in accordance with *Birds and Bird Habitats: Guidelines for Wind Power Projects* (MNR 2011b) to account for the potential continued presence of raptors passing through the area during migration.

## 2.1.3 Correction Factors

Data to calculate correction factors for searcher efficiency and scavenging rates were collected during the mortality monitoring program. Correction factors were calculated to account for carcasses that fell in areas that were not searched, for carcasses that were overlooked, and for carcasses that were removed by scavengers prior to the search.

### 2.1.3.1 Searcher Efficiency Trials

Searcher efficiency trials are designed to correct for carcasses that may be overlooked by searchers during the field surveys. The MNRF (MNR 2011a, 2011b) provides guidance for determining searcher efficiency, expressed as a proportion of carcasses expected to be found by individual searchers.

Searcher efficiency trials consisted of blind tests, where a “tester” placed bird or bat carcasses within the 50 m radius circle under turbines prior to the carcasses search. These were discretely marked (i.e. with thread, or small tags, always placed beneath the carcass and out of sight). The

## ADELAIDE WIND POWER PROJECT: YEAR 1 POST-CONSTRUCTION WILDLIFE MONITORING REPORT (2015)

Methodology  
February 17, 2017

"searcher" was unaware when or where trial carcasses would be placed. Trial carcasses consisted of native birds or bats. Bats were used for 51% of trial carcasses (32 of a total of 63 placed and not scavenged). The location of placed trial carcasses were checked at the end of the searcher monitoring surveys and any remaining carcasses were collected.

Trials adhered to seasonality requirements detailed in the EEMP and MNRF (2011a, 2011b) guidance with a minimum of 10 carcasses used for each searcher per visibility class per season. No more than 3 carcasses were placed at any one time to avoid bias.

For each searcher efficiency trial, the following information was recorded per tester:

- tester and searcher
- turbine number
- date and time placed
- species
- UTM
- direction and distance from the nearest turbine
- marker type used
- carcass condition
- ground cover and visibility class (**Table 2.2, Appendix E**)
- carcass outcome (found, overlooked or scavenged)
- time when the carcass was recovered (if overlooked but not scavenged)

Individual searcher efficiencies ( $Se$ ) were calculated using the following equation:

$$Se = \frac{\text{number of test carcasses found}}{(\text{number of test carcasses placed}) - (\text{number of test carcasses scavenged})}$$

Where two surveyors conducted mortality monitoring during the same season, it was necessary to establish a weighted average that reflected the relative proportion of turbines that each technician surveyed.

The weighted average and overall  $Se$  was calculated as follows:

$$Se_o = Se_1 \left( \frac{n_1}{T} \right) + Se_2 \left( \frac{n_2}{T} \right) + Se_3 \left( \frac{n_3}{T} \right) + \dots$$

where:

$Se_o$	is the Overall Searcher Efficiency
$Se_{1, 2, 3, \dots}$	are Individual Searcher Efficiency Ratings
$n_{1, 2, 3, \dots}$	are the number of turbines surveyed by each searcher
$T$	is the total number of turbines surveyed



Methodology  
February 17, 2017

Searcher efficiency values are known to be much higher for large-bodied versus small-bodied birds (i.e. Erickson et al., 2003; Johnson et al., 2003). As a result, the Se for raptors is assumed to be 1.0 and thus was corrected separately from other bird fatalities.

### 2.1.3.2 Scavenger Trials

Scavenger trials are designed to correct for carcasses that are removed by scavengers before the search period. These trials involved the placement of carcasses at wind turbines followed by scheduled monitoring to determine the rate of removal. These were discretely marked with a small piece of flagging tape.

A scavenger trial was conducted each month in May through October. At least 10 carcasses were used each month, consisting of native birds or bats that were thawed at the time of placement. Bats were used for 28 % (17 of 60) scavenger trial carcasses. Bird carcasses are available from an external source for these trials but bats carcasses, to the best of our knowledge, are not. Due to this being the first year of mortality monitoring at Adelaide, suitable recovered bat carcasses were limited; however surveys were within the range of the one-third (33 %) bat carcasses required (MNR 2011a, 2011b).

Five carcasses were placed at any one time, distributed at different turbines. The following information was recorded for each carcass placement:

- turbine number
- date scavenger carcass was placed
- UTM of carcass location
- direction and distance from turbine
- visibility class (**Table 2.2**)
- species

Monitoring of each scavenger trial carcass then took place during the regularly-scheduled twice weekly mortality monitoring for a 2-week period. During each monitoring event, the following records were taken:

- date
- weather conditions
- presence/absence of carcass
- condition of the carcass, if present

Methodology  
February 17, 2017

Separate scavenger corrections were calculated for each month of the monitoring period, calculated as follows:

$$Sc = \frac{n_{visit\ 1} + n_{visit\ 2} + n_{visit\ 3} + n_{visit\ 4}}{n_{placed} + n_{visit\ 1} + n_{visit\ 2} + n_{visit\ 3}}$$

where:  $Sc$  is the proportion of carcasses not removed by scavengers over the survey period  
 $n_{placed}$  is the total number of carcasses placed  
 $n_{visit\ 1,2,...}$  are the number of carcasses remaining on visits 1 through 4

### 2.1.3.3 Proportion of Area Searched

In accordance with MNRF guidelines (MNR 2011a, 2011b), a 50 m radius around the base of turbines was searched. This area represents the maximum recommended search area. However, due to thick or tall vegetation, it was not always possible to search the entire 50 m radius. Therefore, a correction factor was applied to account for portions of the 50 m radius not searched.

The 50 m search radius around each turbine in the weekly monitoring subset was mapped into visibility classes (**Table 2.2, Appendix E**). Those areas in visibility class 1 and 2 (i.e. easy and moderate) were included in the weekly carcass searches while portions of the search radius in visibility classes 3 and 4 (i.e. difficult to very difficult) were not included. A GPS was used to delineate and measure the area (in meters squared) of visibility class 1 and 2 that was searched.

$P_s$  varied by turbine and survey date and thus was recorded during each survey. The  $P_s$  for each turbine was calculated on a daily basis as follows:

$$P_{S_x} = \frac{\text{area searched within 50 m radius circle}}{\text{total area within 50 m radius circle}}$$

where:  $P_s$  = percent of area searched  
 $X$  = turbine number

The average monthly  $P_s$  for the entire Project (based on 10 turbines) was calculated by averaging:

$$P_S = \frac{P_{S_1} + P_{S_2} + P_{S_3} + \dots + P_{S_{10}}}{10}$$

Scavenger rates for raptors are assumed to be 1.0 based on their longer persistence in the environment (Morrison 2002). Therefore, raptor mortality rates were corrected separately from other bird fatalities.

Methodology  
February 17, 2017

## 2.1.4 Estimate of Mortality

There are numerous published and unpublished approaches to incorporating correction factors into an overall assessment of total bird and bat mortality.

Currently, MNRF recommends the following formula:

$$C = \frac{c}{Se * Sc * Ps}$$

where:	C	is the corrected number of bird or bat fatalities
	c	is the number of carcasses found
	Se	is the proportion of carcasses expected to be found by searchers (searcher efficiency)
	Sc	is the proportion of carcasses not removed by scavengers over the survey period
	Ps	is the percent of the <i>area surveyed</i>

To account for seasonal variability, bird and bat fatalities were estimated separately in each month from May through October. The corrected estimates of bird and bat fatalities were summed over the monitoring period to obtain the estimated number of fatalities for the entire monitoring period. In accordance with provincial guidelines, raptor mortality rates were calculated separately from the bird fatality rate. Estimated mortality rates were expressed per turbine and per MW by dividing the corrected estimates of bird or bat fatalities by the number of turbines or MW in the monitoring subset (i.e., 10 turbines, or 22 MW).

Estimated raptor mortality rates were based on the results of the May to October weekly mortality monitoring surveys. All raptors recovered during these weekly searches are included in calculating the corrected number of raptor fatalities/turbine/year. If applicable, tracked raptors (e.g., any Bald Eagle, Golden Eagle, Peregrine Falcon, or Rough-legged Hawks) are separated from the remainder of the raptor fatalities to calculate the corrected number of tracked raptor fatalities/turbine/year. Results of the supplementary monthly raptor mortality monitoring are reported separately, for the purpose of identifying individual or groups of turbines that may exceed the mortality thresholds. This is in accordance with provincial guidance and as such any raptor fatalities discovered incidentally or during the supplementary monitoring are not included in the raptor (all and tracked) corrected fatality calculations.

For the purposes of applying mortality thresholds, estimated mortality rates were calculated on a per turbine basis for birds. To facilitate this calculation, the average, monthly percent area searched was used for each individual turbine. Monthly searcher efficiency and scavenger rates were considered consistent across all turbines.

Methodology  
February 17, 2017

## **2.2 DISTURBANCE EFFECTS MONITORING: AMPHIBIAN BREEDING HABITAT**

Pre-construction amphibian breeding surveys were conducted in 2013 in accordance with commitments made in the NHA/EIS and EEMP to determine significance and establish baseline conditions. The results of the pre-construction surveys confirmed features 6, 16, and 20 as significant and requiring post-construction disturbance monitoring, as specified within the REA Section I3.

Methods in 2015 were the same as those used in the pre-construction monitoring, as detailed in the EEMP Section 2.2.4.1 Habitat Use Studies. Consistency in the survey methods supports comparisons of habitat use pre- and post-construction.

A total of five survey stations were established and monitored in each of 2013 (pre-construction) and 2015 (post-construction). This included three stations within feature 6 and one station within both features 16 and 20. Survey stations are shown on **Figure 2 (Appendix A)** with survey dates, times, and weather conditions summarized in **Table 2.3 (Appendix E)**.

Nocturnal amphibian call count surveys were conducted following protocols identified in the Great Lakes Marsh Monitoring Program Manual (Bird Studies Canada [BSC] 2008). A surveyor stood at the call station and listened for three minutes. Amphibians were recorded by species within 100 m or outside of 100 m of the surveyor with calling activity ranked using abundance codes: (1) calls not simultaneous – number of individuals can be accurately counted; (2) some calls simultaneous – number of individuals can be reliably estimated; and (3) full chorus – calls continuous and overlapping, so number of individuals cannot be reliably estimated. If calling activity was ranked as one or two, then the number of individuals present was also recorded. Surveys are conducted between one-half hour after sunset and midnight. Three rounds of surveys were conducted at each station (1<sup>st</sup> visit: April 29; 2<sup>nd</sup> visit: May 25; 3<sup>rd</sup> visit: June 22) in 2015.

Results  
February 17, 2017

## 3.0 RESULTS

Results of the first year of mortality and disturbance monitoring for the Adelaide Wind Power Project are provided below.

### 3.1 MORTALITY MONITORING

Results of the mortality monitoring for the 2015 field program are summarized in **Tables 3.1-3.13, Appendix E**. Raw data from the mortality monitoring is provided in **Appendix F**.

Bi-weekly bird and bat mortality monitoring took place between May and October, 2015. Monitoring continued weekly through November for raptors. A complete summary of survey dates, times, and weather conditions during the carcass searches is provided in **Appendix F1** for the bi-weekly monitoring program and **Appendix F2** for the raptor-specific surveys. Although all reasonable effort was made to conduct surveys as scheduled, surveys were not conducted if weather (e.g. lightning, severe fog) or site work (e.g., farming, turbine or access road maintenance) presented safety concerns. **Appendix F3** and **Appendix F4** summarize instances where turbine searches were not conducted due to weather or other safety concerns.

Field forms for the mortality monitoring program, including correction factor trials, are provided in **Appendix G1**.

#### 3.1.1 Searcher Efficiency Trials

The majority of the 2015 program was conducted by one searcher, with a second searcher conducting surveys for two week periods during both the spring (June 11 and 15) and fall (October 19 and 22) seasons. **Table 3.1, Appendix E**, summarizes searcher efficiency rates for each individual, which ranged from 62 % to 91 %. In 2015, the overall weighted searcher efficiency values for each season were: 65 % (spring), 70 % (summer) and 67 % (fall) (**Table 3.2, Appendix E**).

Raw data for the searcher efficiency trials are provided in **Appendix F5** and summarized in **Appendix F6**.

#### 3.1.2 Scavenger Trials

The results of the seasonal scavenger trials are summarized in **Table 3.3, Appendix E**. The proportion of carcasses not removed by scavengers remained relatively consistent over the entire survey period, lowest at 75 % in the fall to 79 % in both the spring and summer months.

Raw data for the scavenger trials are provided in **Appendix F7** and summarized in **Appendix F8**.



Results

February 17, 2017

### 3.1.3 Proportion of Area Searched

The proportion of the 50 m radius that was searched at each turbine is summarized by month in **Table 3.4, Appendix E**.

The average search area varied over the monitoring period, beginning at 0.99 in May, gradually decreasing in June through September (87 % to 77 %), and increasing again in October (91 %).

Raw data for the proportion of area searched are provided in **Appendix F9** and summarized in **Appendix F10**.

### 3.1.4 Mortality

Details of all recorded bird and bat fatalities identified during the regular weekly mortality monitoring program are provided in **Appendix F11**. Details of all fatalities recovered during the monthly raptor mortality monitoring program as well as incidentally by maintenance staff are provided in **Appendix F12**.

#### 3.1.4.1 Raptor Mortality

Four raptor fatalities were recovered during the 26-week bi-weekly monitoring program, including 2 Red-tailed Hawks and 2 Turkey Vultures all recovered during the month of June (**Figure 2, Appendix A, Table 3.5, Appendix E**). Two Turkey Vultures were found at turbine 27 on June 18, 2015 (**Figure 4, Appendix A**), the only turbine recording more than one raptor fatality.

All species are ranked S5(B), secure and common in the province year-round or during the breeding season (B).

Correcting for percent area searched, as searcher efficiency and scavenger rates are assumed to be 1.0 for large-bodied birds, these 4 fatalities were corrected to 0.46 raptors/turbine /year (0.21 raptors/MW/year; **Table 3.6, Appendix E**). Fatality summaries are provided in **Appendix F11**.

No tracked raptor fatalities were recorded during the regular, or supplemental (below), mortality monitoring programs in 2015.

##### 3.1.4.1.1 Supplemental Raptor Monitoring Program Mortalities

One Osprey (*Pandion haliaetus*) was recovered during the supplementary monthly searches at the 8 non-subset turbines (May-October; **Table 3.7, Appendix E**). The Osprey was recovered on June 21, 2015 at turbine 9, with full survey details provided for this species, and all incidental recoveries, in **Appendix F12**. The Osprey is ranked as S5B in Ontario, secure and common during its breeding seasons (May-August).

No raptor fatalities were recorded during the weekly raptor mortality monitoring surveys conducted at the turbine subset during the month of November.

Results

February 17, 2017

## 3.1.4.2 Bird Mortality

A total of 10 bird fatalities (not including raptors) of 6 species were recorded during the 26-week monitoring period from May through October, summarized in **Table 3.8, Appendix E**. Full fatality details are provided in **Appendix F11**.

All native species were provincially ranked S5 (i.e., Secure – common, widespread and abundant in Ontario) or S4 (i.e., Apparently Secure – uncommon but not rare).

Tree Swallow (*Tachycineta bicolor*) was the most common species found (4 individuals), followed by two Golden-crowned Kinglet (*Regulus satrapa*) and individual fatalities of each of the remaining 4 species (Cliff Swallow, *Petrochelidon pyrrhonota*; Mourning Dove, *Zenaida macroura*; Horned Lark, *Eremophila alpestris*; and Ovenbird, *Seiurus aurocapilla*).

The maximum number of bird fatalities (including raptors) recovered during a single mortality monitoring survey at any one turbine was 2. Two Turkey Vultures were recovered on June 18, 2015 at Turbine 27. The maximum number of bird mortalities at all turbines in any one day was also 2 birds. This occurred on two different survey dates; the 2 Turkey Vultures on June 18, as well as an occurrence of 2 bird mortalities (a Golden-crowned Kinglet and a Horned Lark) at different turbines on October 15.

Fatalities occurred in low numbers throughout the search period (**Table 3.10, Appendix E**), with fatalities occurring between late-summer and late-fall. No bird fatalities (excluding raptors) were recovered prior to July 9, 2015 with all recorded small bird fatalities (except potentially the Mourning Dove) corresponding with fall migration (**Figure 3, Appendix A**).

Small bird fatalities were low across the Adelaide facility and were not concentrated in any one area or at any one or group of turbines. No bird fatalities were found at 3 of the 10 search turbines (30 %). A single bird fatality was recovered at 5 of the search turbines (50 %) while more than one fatality across the monitoring season was only recorded at 2 turbines, including turbine 20 (3 fatalities) and 17 (2 fatalities) (**Figure 4, Appendix A**).

Correcting for searcher efficiency, scavenger removal, and percent area searched, corrected turbine specific rates ranged from 0 birds/turbine to 6.93 birds/turbine (**Table 3.9, Appendix E**). Averaged across the entire facility, the 10 recovered carcasses resulted in a corrected value of 2.32 bird fatalities/turbine/year (1.05 birds/ MW/year) (**Table 3.10, Appendix E**).

The recorded mortality rates for the first year of post-construction mortality monitoring at the Adelaide Wind Power Project did not exceed thresholds detailed in Section 15 of the REA for small birds, (i.e., 14 small birds/turbine/year, 10 small birds/turbine/monitoring event, 33 small birds and raptors/monitoring event) or tracked raptors.

## 3.1.4.2.1 Incidental Mortalities

An additional two small bird fatalities were recovered outside of the bi-weekly mortality monitoring program (May 4 – October 28, 2015). This included a Yellow-billed Cuckoo (*Coccyzus americanus*) found on June 19, 2015 and Horned Lark on August 25, 2015, both recovered during monthly raptor searches (**Table 3.7, Appendix E**). The Horned Lark and Yellow-billed Cuckoo are ranked as S5 and SB4, respectively, designated as Secure and Apparently Secure while breeding in Ontario.

These two fatalities are not included in the mortality calculations as they were recovered outside the bi-weekly mortality monitoring parameters. Full survey details for these two mortalities are provided in **Appendix F12**.

## 3.1.4.3 Bat Mortality

A total of 36 bat fatalities representing 4 species were recorded during the 26-week monitoring period from May through October, summarized in **Table 3.11, Appendix E**. Full survey results are available in **Appendix F11**.

The distribution of bat fatalities over the monitoring period is shown on **Figure 3 (Appendix A)**. Bat fatalities were concentrated between mid-July and early-September. September 3 exhibited the highest number of daily fatalities with 7 fatalities followed by August 31 with 5 and August 24<sup>th</sup> with 3 mortalities.

Bat fatalities were highest at turbine 6 (7 fatalities), followed by turbine 17 with 6 fatalities and turbine 20 with 4 fatalities. The remaining turbines in the survey subset experienced 2 or 3 bat mortality events throughout the full 26-week monitoring period (**Table 3.12, Appendix E; Figure 4, Appendix A**).

Hoary Bat (*Lasiurus cinereus*) was the most common species found, representing 44 % of all bat fatalities. Big Brown Bat (*Eptesicus fuscus*) was the next most abundant (28 %), followed by Silver-haired Bat (*Lasionycteris noctivagana*) at 20 % and Red Bat (*Lasiurus borealis*) at 8 %. All species have provincial S-Ranks of S5 (Secure – common, widespread and abundant in Ontario) or S4 (Apparently Secure – uncommon but not rare).

Correcting for searcher efficiency, scavenger removal, and percent area searched, the 36 recovered carcasses resulted in a corrected value of 8.57 bat fatalities/ turbine/year (3.87 fatalities/MW/year; **Table 3.13, Appendix E**).

## 3.1.4.3.1 Incidental Mortalities

Five additional bat fatalities were recovered incidentally during supplemental raptor searches or by maintenance crews. This includes 2 Silver-haired Bats, 1 Big Brown Bat, 1 Hoary Bat, and 1 Little Brown Myotis (*Myotis lucifugus*; **Table 3.7, Appendix E**). These fatalities are not included in the mortality calculations as they were recovered outside the bi-weekly mortality monitoring parameters.

## ADELAIDE WIND POWER PROJECT: YEAR 1 POST-CONSTRUCTION WILDLIFE MONITORING REPORT (2015)

Results

February 17, 2017

The Little Brown Myotis was added in the Species at Risk in Ontario (SARO) List as endangered in January of 2013. On December 17, 2014, the Government of Canada added Little Brown Myotis to Schedule 1 of the Species at Risk Act (SARA).

### 3.1.5 Notifications

As detailed in the EEMP and REA Condition E12(2), notifications were made to MNRF when any species at risk (provincially threatened or endangered) were recovered during the mortality program. Notifications were also made to the MNRF when any raptor species were recovered. Both types of mortalities were registered on the Ontario government online registry to allow the possession of dead wildlife.

Five notifications were made for 6 individuals recovered during the 2015 monitoring program, 4 for raptor fatalities and 1 for a species at risk fatality. Copies of each notification are provided in **Appendix H**.

Raptor notifications included the following:

- Red-tailed Hawk fatality on June 11, 2015 at turbine 11
- Red-tailed Hawk fatality on June 15, 2015 at turbine 6
- Two Turkey Vulture fatalities on June 18, 2015 at turbine 27
- Osprey fatality on June 21, 2015 at turbine 9

Species at risk notifications included the following:

- Little Brown Myotis fatality on August 25, 2015 at turbine 21

### 3.1.6 Summary

The following mortality rates occurred at the Adelaide Wind Power Project during the first year of monitoring:

- 0.46 raptors/turbine/year
- 0 provincially tracked raptors/turbine/year
- 2.32 small birds/turbine/year across the wind power Project:
  - range of 0 – 6.93 birds/turbine at individual turbines
- 8.57 bats/turbine/year

The maximum bird mortality during a single mortality monitoring survey was:

- 2 birds at any one turbine
- 2 birds (including raptors) at multiple turbines



Results

February 17, 2017

## 3.2 DISTURBANCE EFFECTS MONITORING: BREEDING AMPHIBIANS

A total of six species were recorded during the 2015 amphibian surveys conducted at Adelaide, including American toad (*Anaxyrus americanus*), green frog (*Lithobates clamitans*), gray treefrog (*Hyla versicolor*), northern leopard frog (*Lithobates pipiens*), spring peeper (*Pseudacris crucifer*) and western chorus frog (*Pseudacris triseriata*). Spring Peeper was the most abundant species, with full choruses documented at a 3 of the 5 surveyed stations and the most widespread as it occurred at 4 of the 5 stations surveyed. Gray treefrog was also recorded at 4 of the 5 stations surveyed but at lower levels (call counts of 1 or 2). Maximum call-count results by survey station are provided in **Table 3.14, Appendix E**. Field forms are provided in **Appendix G2**.

Results of the pre-construction woodland and wetland amphibian surveys conducted in 2013 were assessed for significance using the Draft Significant Wildlife Habitat Ecoregion 7E Criterion Schedule (MNR, 2012). To meet the criteria for significance the studies must confirm: *Presence of breeding population of 2 or more of the listed frog species with at least 20 individuals (adults, juveniles, eggs/larval masses)*. Methods used in 2013 to test for significance were repeated in 2015. Based on 2015 survey results, all three features (6, 16, and 20) continue to meet these criteria for significance.

Discussion  
February 17, 2017

## 4.0 DISCUSSION

A review of results, comparison to published literature, and discussion on observed patterns, if applicable, of the first year of mortality and disturbance monitoring at the Adelaide Wind Power Project are provided in the sections below.

### 4.1 MORTALITY MONITORING

Results presented in this 2015 post-construction monitoring report have provided the first of three years of mortality monitoring data, establishing a baseline to compare 2016 and 2017 results. The thresholds in 2015 were not exceeded for tracked raptors, small birds, single mortality events, or bats; however, the raptor threshold was exceeded ( $>0.20$  raptors/turbine/year).

Details on search parameters, results and any observed fatality patterns are provided below.

#### 4.1.1 Searcher Efficiency Trials

Average rates in Canada for searcher efficiency are 58-67 % (BSC et al., 2014). While slightly higher than average, rates at the Adelaide facility (65-70 %) are consistent with these data (**Table 3.2, Appendix E**). Factors that are thought to influence searcher rates may be vegetation height and thickness, ground visibility, individual observer variation, and size of birds (NWCC, 2010).

The overall seasonal rate of recovery remained relatively consistent over the monitoring program, with the highest recovery rate realized during the summer period.

#### 4.1.2 Scavenger Trials

Rates of carcass removal were consistent throughout the spring, summer and fall of 2015 such that 75-79 % of carcasses remained after the trials (**Table 3.3, Appendix E**). These removal rates did not show a strong seasonal variation, which is consistent with seasonal data from wind projects across Canada (BSC et al., 2014).

#### 4.1.3 Proportion of Area Searched

Turbine area searched was highest at the beginning of the search period (99 % in May) and decreased as crop cover increased over the growing season (i.e., July-September, 87 % to 78 %). Crop harvesting in early fall resulted in an increased search area in October to near-spring levels (91 %; **Table 3.4, Appendix E**).

Discussion  
February 17, 2017

## 4.1.4 Bird Mortality

### 4.1.4.1 Background

Direct mortality from collisions with wind turbines is a potential effect during operation at wind turbine facilities. Each turbine that is installed has an impact by directly adding to mortality rates (Masden et al. 2010). Whether or not this source of mortality is sufficient to impact populations is the critical issue from a conservation perspective.

Various studies have been conducted throughout North America to document bird collisions at wind facilities and to determine why and the extent to which they occur. It appears that most avian collisions are of nocturnal migratory songbirds (Kingsley and Whittam 2007, Erickson et al. 2014, AWWI 2014) based on a review of available literature, at least in part because they are the most abundant species at wind energy facilities (National Academy of Sciences 2007). In an analysis of mortality monitoring results from 116 studies at more than 70 wind energy facilities, small passerines accounted for 62.5 % of all bird fatalities, upland game birds for 8.2% and diurnal raptors for 7.8 % (Erickson et al. 2014).

BSC et al. (2014) found similar results to Erickson et al. (2014) for the raptor guild, representing 8 % of all bird fatalities in Ontario. Of these raptor mortalities, Turkey Vulture (2.29 %) and Red-tailed Hawk (3.99 %) are the most commonly recovered species. Although species composition of raptor mortalities may seem relatively consistent, another recent study noted that raptor fatality rates exhibit high inter-annual variation (Smallwood, 2013). Seasonal variability has also been documented, where mortalities generally peak during the spring (Ontario and Canada) and fall (Canada only) migration period, although numbers are low overall (BSC et al. 2014). Considering the aforementioned raptor mortality rate variability, Strickland et al. (2011) reported raptor fatality rates ranging from 0 to 0.49 raptors/MW, with a median of 0.08 raptors/MW, at projects across North America (excluding California) that used modern, monopole turbines.

The most common species of small passerine reported across several North American studies are Horned Lark along with Red-eyed Vireo (*Vireo olivaceus*), and Golden-crowned Kinglet (BSC et al. 2014, Erickson et al. 2014, Zimmerling et al. 2013). In Canada the overall estimated mortality of these species represents less than 0.01% of their Canadian populations (Zimmerling et al. 2013).

Most fatalities at operational facilities have been found from May through October (Erickson et al. 2014, BSC et al. 2014), with the fall migration period (August to October) exhibiting the majority of all fatalities (Environment Canada et al. 2011, Erickson et al. 2014).

The most recent compilation of available bird mortality data from wind energy facilities in North America (Erickson et al. 2014) indicates a bias-corrected estimate of overall bird mortality rate between 2.10/MW/year and 3.35/MW/year. These values are within the range reported by AWWI (2014) of 3 to 5 birds/MW/year.

Discussion

February 17, 2017

Zimmerling et al. (2013) report an average of 8.2 birds (+/- 1.4, 95 % confidence interval [CI]) killed per turbine per year at 43 wind farms in Canada. This study used a correction factor to increase the radius around turbine from the standard 50 m to 85 m, based on results of an unpublished study by the authors.

The most recent Ontario data, compiled by BSC et al. (2014), indicate an average of 5.45 birds (+/- 0.76, 95% CI) killed per turbine per year based on data from 25 wind farms in Ontario. This compilation used a 50 m search radius in the mortality correction as this method is standard practice across many Canadian studies, and is the mandatory search radius for all projects currently being monitored in Ontario (BSC et al. 2014).

Bird mortality rates observed at operational facilities are considered low, with no evidence of large scale fatality events or significant population impacts in Ontario (Friesen 2011). Monitoring results to date from operational facilities indicate that wind turbines are a small contributor to overall bird mortality when compared to other anthropogenic structures and industrial sectors (Arnett et al. 2007, Kingsley and Whittam 2007, National Academy of Sciences 2007, Kerlinger et al. 2011, Zimmerling et al. 2013) or other sources of anthropogenic mortality (Calvert et al. 2013). Because raptors have relatively low population densities and reproductive rates, population recovery from mortality effects can be slow (Kingsley and Whittam 2007). As such, raptors may be more susceptible to population level impacts than other bird species (Manville 2009, as referenced in Zimmerling et al. 2013).

Zimmerling et al. (2013) indicate that even a tenfold increase in total mortality from wind turbine operation in Canada would represent a mortality level that is orders of magnitude smaller than from many other sources of collision mortality in Canada. Less than 0.01 % of the continent-wide population for most species is estimated to be killed annually by collisions with wind turbines (Erickson et al. 2014).

### 4.1.4.2 Adelaide Wind Power Project

#### 4.1.4.2.1 Raptor Mortality

A total of five raptor mortalities were reported during the first year of mortality monitoring at Adelaide in 2015. This included two Red-tailed Hawks and two Turkey Vultures recovered during the regular monitoring program as well as one additional fatality, an Osprey, recovered during the monthly supplemental monitoring. All species are common in Ontario, ranked S5 (Common, widespread, and abundant in the province).

Red-tailed Hawks and Turkey Vultures are the two more commonly encountered raptor fatalities at Ontario wind facilities (3.99 % and 2.29 %, respectively; BSC et al. 2014). Osprey is rarely recovered, ranked 109<sup>th</sup> of recovered species in Ontario, comprising 0.19 % of all turbine fatalities in the province (BSC et al. 2014).



## ADELAIDE WIND POWER PROJECT: YEAR 1 POST-CONSTRUCTION WILDLIFE MONITORING REPORT (2015)

Discussion

February 17, 2017

Seasonal variability in mortality rates is typically attributed to periods where large numbers of migrating birds (including raptors) move through the province while travelling between their breeding and wintering grounds. Increases have been recorded most strongly during the fall migration period (August to October) which exhibits the majority of all bird fatalities (Environment Canada et al. 2011, Erickson et al. 2014, BSC et al., 2014). In this regard, the recorded raptor fatalities at the Adelaide project were very unusual. The timing of all five raptor fatalities corresponds with the nestling season (Turkey Vulture and Osprey, Cadman et al. 2007; Red-tailed Hawk, Preston and Beane 2009), with no fatalities recorded during spring or fall migration; a time when raptor fatalities are mostly likely to occur. Furthermore, all five fatalities occurred during a very short, eleven day period (June 11 to June 21), with both Turkey Vultures fatalities occurring at the same day at the same turbine. Finding two bird fatalities at a single turbine during a single monitoring event is rare, being reported only a handful of times in Ontario (Friesen 2011), and finding two raptors at the same turbine during the same monitoring event is even more rare (Stantec, unpublished data). It is particularly unusual this would occur during the breeding season, when raptor mortality is typically very low. The reason for these unusual findings at the Adelaide Wind Power Project is not clear.

Red-tailed Hawks were not recorded nesting within the zone of investigation (i.e. 120m from the Project Location) during the pre-construction surveys conducted in 2010 (Golder) and 2011 and 2012 (Stantec); however, this is a common breeding species in agricultural settings and may have been nesting in the local landscape in 2015. The species typically nests in woodland habitat; potential nesting habitat is present in the scattered woodlots in the local landscape. Likewise, the Turkey Vulture is a common species in agricultural settings. It naturally nests in sites such as caves, rocky cliffs or hollow trees, but in agricultural settings regularly nests in buildings, such as abandoned barns. Nesting sites in buildings may occur in the local landscape. While both species were likely present in the local landscape during the breeding season, the same would be true for most wind farms in southern Ontario and not unique to the Adelaide Wind Power Project. Although the presence of suitable breeding habitat does not appear to explain the unusual mortality during the nesting season at this project in 2015, but the association between nesting location and risk is currently unknown.

Unlike the other two species, Osprey is unlikely to be nesting in the local landscape. This species feeds almost exclusively on fish (Poole et al. 2002), and are therefore associated with aquatic habitats for both foraging and nesting. Osprey build nests in trees, utility poles or other structures near or over open water including lakes and rivers (Cadman et al. 2007). No Osprey nests are known to occur within the vicinity of the Project (Stantec 2012b). Suitable aquatic habitat (i.e. lakes or rivers) do not occur in the local landscape (**Figure 1, Appendix A**). The closest potential Osprey habitat for nesting and foraging exists along the larger watercourses to the south in Strathroy (impoundments of the Sydenham River approximately 5 kilometers from closest turbine) and north of the facility (Ausable River approximately 3 kilometers from closest turbine).

Overall, based on the data collected to date, the Adelaide Wind Power Project does not appear to have any unique risk factors that would explain the unusual mortality recorded during the nesting season. It is likely the mortality recorded in 2015 was an anomaly and it is quite



## ADELAIDE WIND POWER PROJECT: YEAR 1 POST-CONSTRUCTION WILDLIFE MONITORING REPORT (2015)

Discussion

February 17, 2017

unlikely to occur again in future years. Regardless, the raptor mortality recorded in 2015 of 0.46 raptors/turbine/year was above the provincial threshold (MNRF 2011b). As such, in accordance with the EEMP and the REA, the following steps are required;

- Two years of subsequent scoped mortality and cause and effect monitoring for raptors (starting in 2016).
- Following the scoped monitoring, implementation of operational mitigation for the life of the facility.
- Effectiveness monitoring at individual turbines for three years, following implementation of mitigation.

Stantec has developed a supplemental raptor program to meet the scoped mortality and cause and effect monitoring requirements of the EEMP and REA.

Components of the supplemental monitoring program are described **Appendix I**. This includes:

- supplemental monitoring for raptors in accordance with REA Section 18
  - scoped mortality monitoring: increasing the frequency of monthly raptor monitoring at non-subset turbines to weekly (May-July)
  - cause and effect monitoring: background review (once), twice annual habitat mapping of suitable nest and foraging habitat (April, mid-May/June), and weekly behavioural monitoring (May-July)

### 4.1.4.2.2 Small Bird Mortality

The results from the first year of monitoring at Adelaide identified a bird fatality rate of 2.32 birds/turbine/year. This is well below the Ontario threshold of 14 birds/turbine/year and is also lower than the current estimated provincial mortality rate of 5.45 birds/turbine/year (+/- 0.76, 95 % CI; BSC et al. 2014).

Overall, small bird fatalities were low at the Adelaide facility over the monitoring period in 2015, recovering 10 individuals in total. Tree Swallow was the most common species found at the Adelaide facility (4 individuals), followed by two Golden-crowned Kinglets and individual fatalities of each of the remaining 4 species (Cliff Swallow, Mourning Dove, Horned Lark, and Ovenbird). With the exception of Ovenbird, all recovered species are within the top 10 most commonly recovered species at Ontario wind power facilities. Ovenbird is a rarely recovered fatality at wind facilities in Ontario, comprising 0.39 % of all fatalities (BSC et al. 2014).

No bird fatalities (excluding raptors) were recovered prior to July 9, 2015 with most fatalities occurring between late-summer and late-fall, which generally corresponds to the fall migration period. This is consistent with research elsewhere that documents the fall migration period (August to October) comprising the majority of all wind turbine fatalities (Environment Canada et al. 2011, Erickson et al. 2014).



# ADELAIDE WIND POWER PROJECT: YEAR 1 POST-CONSTRUCTION WILDLIFE MONITORING REPORT (2015)

Discussion

February 17, 2017

No fatalities of provincial or federal bird species at risk were found.

Turbine specific fatality patterns were not apparent. No notable location or pattern of turbines that experienced mortality against those that did not, or in numbers of fatalities observed. Additional monitoring from 2016 and 2017 may provide additional data to further evaluate patterns and risk factors.

Overall, the results of the first years of mortality monitoring at the Adelaide Wind Power Project demonstrated low small bird fatality rates.

## 4.1.5 Bat Mortality

Direct impact to bats through collision with wind turbines has been documented in post-construction monitoring reports and peer reviewed literature. Overall bat mortality (of all species) has been reported in the range of 0.3 to 40 bats/MW/year in projects in North America (Arnett et al. 2007, Strickland et al., 2011). Bats, as a group, are generally more commonly observed fatalities than birds at operational wind project facilities (BSC et al., 2014; AWWI, 2014). In Canada, 70 % of the casualties found were bats (4020 bats of 9 species found at 1367 turbines included in the monitoring results) (BSC et al. 2014). In Ontario, 75 % of the casualties found were bats (3,598 bats of 8 species found at 980 turbines included in the monitoring results).

Comprehensive studies of bat mortality rates at wind-energy facilities throughout North America indicate that bat mortalities are highest during the fall migration period (July through September, peaking in August; BSC et al. 2014) with more than 50% of the bat mortalities occurring during August (Johnson 2005; Kunz et al. 2007).

Smallwood et al. (2013) compared bat fatality rate estimates among 71 North American wind-energy projects with turbines ranging from 18.5 to 90 m in height. Although results contain large, unadjusted biases and uncertainties in extrapolated data are high, they estimate an annual mortality of 651,000-888,000 bats in the U.S. (Smallwood et al. 2013). In Canada, recent post-construction monitoring results indicate a total annual mortality of 25,937 bats (BSC et al. 2014). The most recent Ontario data indicate an average of 19.08 bats (+/- 2.38, 95 % CI) killed per turbine per year based on data from 25 wind farms in Ontario with rates ranging from 0-72 bats per year (BSC et al. 2014). Population-level effects are not well understood, however; during a two year study at a windfarm within an agriculture landscape in Minnesota, only an estimated small fraction (1.3 %) of fall migrating bats present (more than 90,000) collided with wind turbines (Johnson et al. 2004).

### 4.1.5.1 Adelaide Wind Power Project

The first year of bat monitoring at the Adelaide Wind Power Project identified a corrected mortality rate of 8.57 bats/turbine/year. This is below the provincial threshold of 10 bats/year/turbines and below the current provincial average of 19.08 bats/turbine/year (BSC et al. 2014).



Discussion

February 17, 2017

Bat mortalities were highest at Adelaide between mid-July and mid-October, with a distinct peak during the last week of August and first week of September (**Figure 3, Appendix A**). This corresponds with research elsewhere that documents increased bat fatalities during the fall migration period (July through September, peaking in August; BSC et al. 2014). This occurs as migratory tree bats (e.g., Hoary, Red, and Silver-haired Bats) move through the area.

Bat fatalities were highest at turbine 6 (7 fatalities), followed by turbine 17 with 6 fatalities and turbine 20 with 4 fatalities. The remaining turbines in the survey subset experienced 2 or 3 bat mortality events throughout the full 26-week monitoring period (**Table 3.12, Appendix E; Figure 4, Appendix A**). No clear pattern of bat fatalities is apparent based on turbine location and proximity to natural features.

One species at risk bat fatality (Little Brown Myotis) was documented during the 2015 monitoring program, recovered during the supplemental monthly raptor surveys at non-subset turbines. This individual was submitted to the CHWC in accordance with guidance provided by MNR (MNR 2011a).

## 4.2 DISTURBANCE EFFECTS MONITORING: BREEDING AMPHIBIANS

The NHA/EIS for the Adelaide Wind Power Project (Stantec 2012b) concluded that potential impacts to amphibian habitat were anticipated to be negligible. The closest project component to amphibian habitat was 17.8 m away, which provides a suitable buffer and construction impacts would be short term in duration. The one year of post-construction monitoring was completed evaluation the accuracy of this prediction. Based on 2015 survey results, all three features (6, 16, and 20) continue to meet the criteria for significance and therefore are not showing significant impacts from construction or operation.

Some variation in species occupancy was observed between pre-construction and post-construction. There was a decrease in the number of species recorded at three stations, an increase at one station and no change at one station (**Table 3.14, Appendix E**). Species abundance varied between pre- and post-construction, increasing or remaining consistent for spring peeper and generally declining for gray treefrog.

Variation in annual population indices can result from natural extrinsic environmental factors (Timmermans, 2001; Cook et al., 2011). While some variation in results was observed, all three features continued to support breeding amphibian populations and met the criteria for significant wildlife habitat. The results of the monitoring surveys do not indicate an ecologically significant disturbance impact occurred as a result of the project access roads.

The 2015 disturbance monitoring program for amphibian breeding habitat meets the monitoring commitment detailed in the EEMP and REA. No further amphibian monitoring is required.

## 5.0 SUMMARY AND RECOMMENDATIONS

This report summarizes the results of the first year of post-construction mortality monitoring and disturbance monitoring at the Adelaide Wind Power Project.

Correcting for searcher efficiency, scavenger removal, and percent area searched, the following mortality rates were recorded in 2015:

- 0.46 raptors/turbine/year
- 0 provincially tracked raptors/turbine/year
- 2.32 small birds/turbine/year across the wind power project
  - range of 0 – 6.93 birds/turbine at individual turbines
- 8.57 bats/turbine/year

The maximum bird mortality during a single mortality monitoring survey was:

- 2 birds at any one turbine
- 2 birds (including raptors) at multiple turbines

Thresholds for bats, small birds, tracked raptors and single mortality events were not exceeded in 2015. However, the recorded rate of 0.46 raptors/turbine/year exceeded the threshold set out by the province (MNR 2011b) and as stipulated in the REA Section 15 of 0.2 raptors/turbine/year. Based on this result, two years of scoped mortality and cause and effect monitoring for raptors are required in 2016 and 2017 as discussed in **Appendix I**.

Therefore, monitoring in 2016 will include the following:

- Mortality Monitoring (as prescribed in the EEMP):
  - bi-weekly monitoring for birds and bats at 10 turbine subset (May-October)
  - monthly monitoring at 8 non-subset turbines (May-November)
  - weekly monitoring at 10 turbine subset (November)
- Scoped Monitoring (as devised by Stantec, **Appendix I**):
  - weekly monitoring for raptors at 8 non-subset turbines (May-July)
- Cause and Effect Monitoring for raptors (as devised by Stantec, **Appendix I**):
  - background review of nest records in relation to turbine locations
  - two rounds of habitat mapping of suitable nest and foraging habitat (April, mid-May/June)
  - behavioural surveys weekly in May, June, and July.

## **ADELAIDE WIND POWER PROJECT: YEAR 1 POST-CONSTRUCTION WILDLIFE MONITORING REPORT (2015)**

Summary and Recommendations  
February 17, 2017

One provincially endangered species, the Little Brown Myotis, was recovered at the Adelaide facility during the 2015 monitoring program supplemental monthly monitoring. The single Little Brown Bat fatality was an isolated event in 2015, with mortality restricted to a single individual.

The post-construction amphibian surveys conducted in 2015 identified no significant impacts to amphibian breeding. This monitoring fulfils the disturbance monitoring requirement as detailed in the REA and EEMP, and no further monitoring is required.

This report meets the annual post-construction reporting requirement of REA Section 111 and 112 for the first year of monitoring at the Adelaide Wind Power Project.

## 6.0 REFERENCES

- American Wind Wildlife Institute (AWWI). 2014. Wind Turbine interactions with wildlife and their habitats: a summary of research results and priority questions. Washington, DC. Available online at [www.awwi.org](http://www.awwi.org)
- Arnett, E. B., D. B. Inkley, D. H. Johnson, R. P. Larkin, S. Manes, A. M. Manville, J. R. Mason, M. L. Morrison, M. D. Strickland, and R. Thresher. 2007. Impacts of wind energy facilities on wildlife and wildlife habitat. Wildlife Society Technical Review 07-2. The Wildlife Society, Bethesda, Maryland, USA.
- Bird Studies Canada (BSC), Canadian Wind Energy Association, Environment Canada and the Ontario Ministry of Natural Resources. 2014. Wind energy Bird and Bat Monitoring Database Summary of the Findings from Post-construction Monitoring Reports. July 2014.
- Bird Studies Canada (BSC). 2008. Marsh Monitoring Program Participant's Handbook for Surveying Amphibians. Published by Bird Studies Canada in cooperation with Environment Canada and the U.S.
- Cadman, M. D., D.A. Sutherland, G.G. Beck, D. Lepage, A.R. Couturier. 2007. Atlas of the Breeding Birds of Ontario, 2001-2005. (eds) Bird Studies Canada, Environment Canada, Ontario Field Ornithologists, Ontario Ministry of natural resources, and Ontario Nature, Toronto, xxii + 318pp.
- Calvert, A. M., C. A. Bishop, R. D. Elliot, E. A. Krebs, T. M. Kydd, C. S. Machtans, and G. J. Robertson. 2013. A synthesis of human-related avian mortality in Canada. *Avian Conservation and Ecology* 8(2): 11. <http://dx.doi.org/10.5751/ACE-00581-080211>
- Cook, R.P., T. Tupper, P.W.C. Paton, and B. Timm. 2011. Effects of temperature and temporal factors on anuran detection probabilities at Cape Cod National Seashore: Implications for Long-Term Monitoring. *Herpetological Conservation and Biology* 6(2):25-39.
- Environment Canada, the Canadian Wind Energy Association and the Ontario Ministry of Natural Resources. 2011. Wind Energy Bird and Bat Monitoring Database Summary of the Findings from Post-construction Monitoring Reports. November 2011. 17pp.
- Environment Canada. 2015. Great Lakes Significant Events – for March - May 2015. Available: <http://www.ec.gc.ca/eau-water/default.asp?lang=En&n=92F5CC6B-1>
- Erickson, W.P., M.M. Wolfe, K.J. Bay, D.H. Johnson, and J.L. Gehring. 2014. A Comprehensive Analysis of Small-Passerine Fatalities from Collision with Turbines at Wind Energy Facilities. *PLoS ONE* 9(9): e107491.

## ADELAIDE WIND POWER PROJECT: YEAR 1 POST-CONSTRUCTION WILDLIFE MONITORING REPORT (2015)

### References

February 17, 2017

Erickson, Wally, Karen Kronner and Bob Gritski. 2003. Nine Canyon Wind Power Project Avian And Bat Monitoring Report: September 2002 – August 2003. Prepared For: Nine Canyon Technical Advisory Committee. October 2003.

Friesen, L. 2011. No evidence of large-scale fatality events at Ontario wind projects in Ontario Birds, Volume 29, No. 3, December 2011: pages 149- 155.

Johnson, G.D., 2005. A review of bat mortality at wind-energy developments in the United States. Bat Research News 46(2): 45-49.

Johnson, G.D., M.K. Perlik, W.P. Erickson and M.D. Strickland. 2004. Bat activity, composition and collision mortality at a large wind plant in Minnesota. Wildlife Society Bulletin 32(4): 1278-1288.

Johnson, Greg, Wally Erickson, Joe White and Randy McKinney. 2003. Avian and Bat Mortality During the First Year of Operation at the Klondike Phase I Wind Project, Sherman County, Oregon. Prepared for: Northwestern Wind Power. March 2003.

Kerlinger, P., Curry, R., Guarnaccia, J. 2011. Bird collision impacts at wind turbines in eastern North America LLC: from “harvesting wind energy on the Delmar Virginia peninsula”. <Presented September 14, 2011>.

Kingsley, A. and B. Whittam. 2007. Wind Turbines and Birds: A Background Review for Environmental Assessment. Prepared for the Canadian Wildlife Service. Draft April 2, 2007.

Kirk, David A. and Michael J. Mossman. 1998. Turkey Vulture (*Cathartes aura*), The Birds of North America Online (A. Poole, Ed.). Ithaca: Cornell Lab of Ornithology; Retrieved from the Birds of North America Online: <http://bna.birds.cornell.edu/bna/species/339>

Kunz, T.H., E.B. Arnett, W.P. Erickson, A.R. Hoar, G.D. Johnson, R.P. Larkin, M.D. Strickland, R.W. Thresher and M.D. Tuttle. 2007. Ecological impacts of wind energy development on bats: questions, research needs, and hypotheses. Front. Ecol. Environ. 5(6): 315-324.

Masden, E.A., A.D. Fox, R.W. Furness, R. Bullman, and D.T. Haydon. 2010. Cumulative impact assessments and bird/wind farm interactions: developing a conceptual framework. Environ. Impact Assess. Rev. 30: 1–7.

Morrison, M. 2002. Searcher Bias and Scavenging Rates in Bird/Wind Energy Studies. National Renewable Energy Laboratory, U.S. Department of Energy Laboratory Operated by Midwest Research Institute. 1617 Cole Boulevard Golden, Colorado 80401-3393.

National Academy of Sciences (NAS). 2007. Environmental Impacts of Wind-Energy Projects. Committee on Environmental Impacts of Wind-Energy Projects, Board on Environmental Studies and Toxicology, Division on Earth and Life Studies, National Research Council of the National Academies. The National Academies Press, Washington, D.C., USA.





## ADELAIDE WIND POWER PROJECT: YEAR 1 POST-CONSTRUCTION WILDLIFE MONITORING REPORT (2015)

### References

February 17, 2017

National Wind Coordinating Collaborative (NWCC). 2010. Wind Turbine Interactions with Birds, Bats, and their Habitats: A Summary of Research Results and Priority Questions. Spring 2010. 8p.

Ontario Ministry of Natural Resource (MNR). 2012. Draft Significant Wildlife Habitat Ecoregion 7E Criterion Schedule.

Ontario Ministry of Natural Resources (MNR). 2011a. Bats and Bat Habitats. Guidelines for Wind Power Projects. 24 pp. July, 2011.

Ontario Ministry of Natural Resources (MNR). 2011b. Birds and Bird Habitats. Guidelines for Wind Power Projects. 32 pp. December 2011.

Ontario Partners in Flight (PIF). 2006. Ontario Landbird Conservation Plan: Lower Great Lakes/St. Lawrence Plain (North American Bird Conservation Region 13), Priorities, Objectives and Recommended Actions. Environment Canada (Ontario Region) and Ontario Ministry of Natural Resources. Final Draft, February 15, 2006.

Poole, Alan F., Rob O. Bierregaard and Mark S. Martell. 2002. Osprey (*Pandion haliaetus*), The Birds of North America Online (A. Poole, Ed.). Ithaca: Cornell Lab of Ornithology; Retrieved from the Birds of North America Online: <http://bna.birds.cornell.edu/bna/species/683>

Preston, C. R. and R. D. Beane. 2009. Red-tailed Hawk (*Buteo jamaicensis*), The Birds of North America Online (A. Poole, Ed.). Ithaca: Cornell Lab of Ornithology; Retrieved from the Birds of North America Online: <http://bna.birds.cornell.edu/bna/species/052>

Smallwood, S. 2013. Comparing Bird and Bat Fatality-Rate Estimates Among North American Wind-energy Projects. Wildlife Society bulletin 37 (1):19-33, 2013; DOI: 10.1002/wsb.260

Stantec Consulting Ltd. 2012a. Suncor Energy Adelaide Wind Energy Project Environmental Effects Monitoring Plan For Wildlife (EEMP). July 2012.

Stantec Consulting Ltd. 2012b. Suncor Energy Adelaide Wind Energy Project Natural Heritage Assessment & Environmental Impact Study. July 2012.

Stantec Consulting Ltd. 2012c. Suncor Energy Adelaide Wind Project Addendum I. October 2012.

Stantec Consulting Ltd. 2013a. Suncor Energy Adelaide Minor Modifications. February 2013.

Stantec Consulting Ltd. 2013b. Suncor Energy Adelaide Project Modifications. November 2013.



## ADELAIDE WIND POWER PROJECT: YEAR 1 POST-CONSTRUCTION WILDLIFE MONITORING REPORT (2015)

### References

February 17, 2017

- Stantec Consulting Ltd. 2009-2012. Wolfe Island EcoPower Centre: Post-construction Follow-up Plan Bird and Bat Resources – Monitoring Reports. Nos. 1-7. Available at: <http://www.transalta.com/facilities/plants-operation/wolfe-island/post-construction-monitoring>
- Stantec Consulting Ltd. 2010. Melancthon EcoPower® Centre Post-Construction Bird and Bat Monitoring Report: 2009. Prepared for TransAlta Corporation. February 2010.
- Stickland, D., E. B. Arnett, W.P. Erickson, D.H. Johnson, G.D. Johnson, M.L. Morrison, J.A. Shaffer, W. Warren-Hicks. 2011. Comprehensive Guide to Studying Wind Energy/Wildlife Interactions. Prepared for the National Wind Coordinating Collaborative. Washington D.C., USA.
- Timmermans, Steve. 2001. Temporal Relations Between Marsh Bird and Amphibian Annual Population Indices and Great Lakes Water Levels: A Case Study from the Marsh Monitoring Program. Published by Bird Studies Canada. 20 pp.
- Zimmerling, J.R., A.C. Pomeroy, M.V. d'entremont, and C.M. Francis. 2013. Canadian estimate of bird mortality due to collisions and direct habitat loss associated with wind turbine developments, *Avian conservation and Ecology* XX(YY):ZZ. [online] URL: <http://www.ace-eco.org/volXX/issYY/artZZ/>

# APPENDIX A: FIGURES

**Legend**

- Project Boundary
- Turbine Subset
- Project Components**
- MET Tower
- Turbine Location
- Access Road
- Collector Line
- Substation Constructible Area
- Existing Features**
- Expressway / Highway
- Road
- Watercourse
- Constructed Drain
- Waterbody

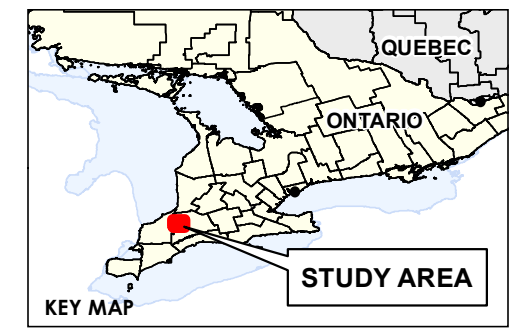
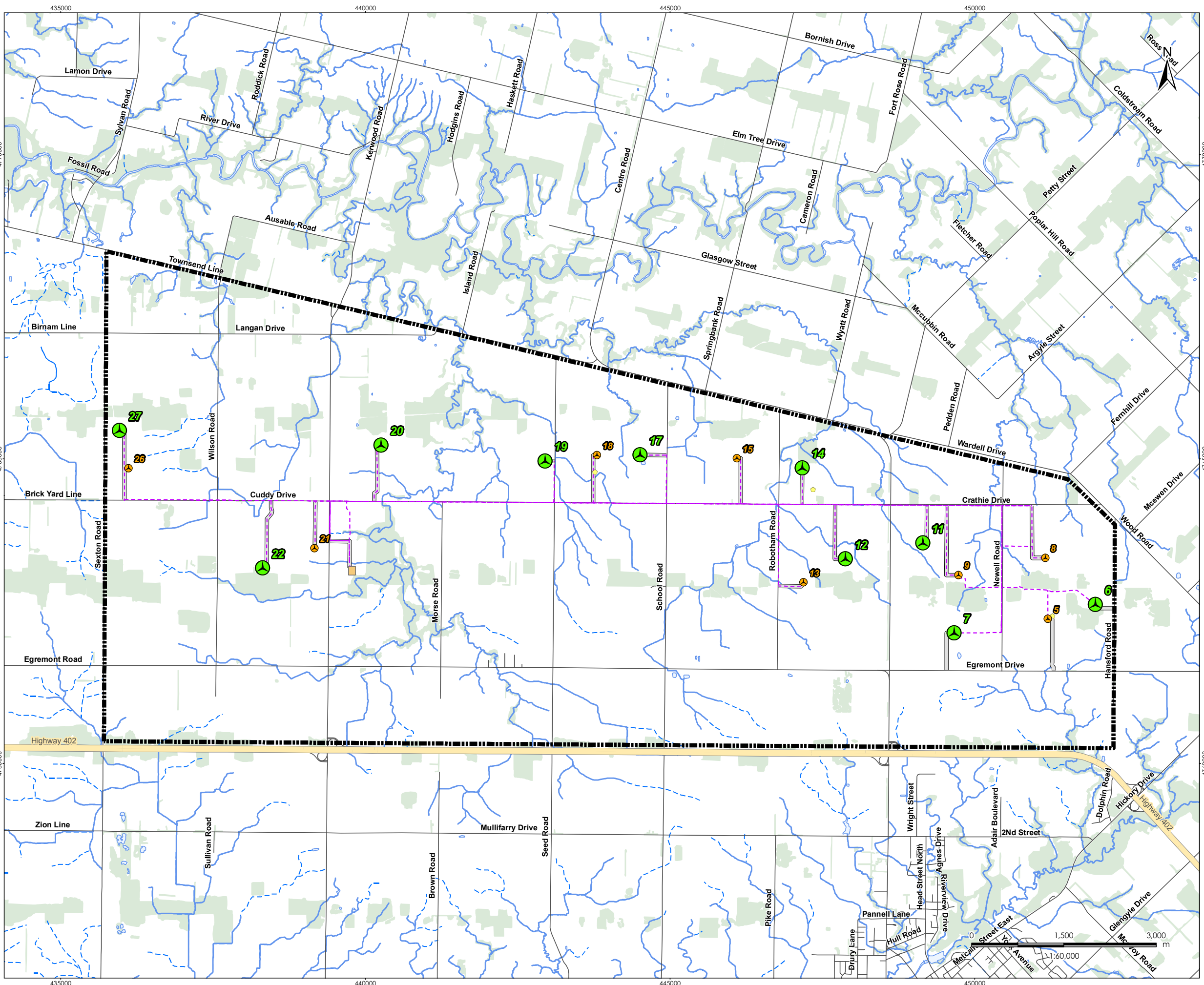

- Notes**
1. Coordinate System: NAD 1983 UTM Zone 17N
  2. Base features produced under license with the Ontario Ministry of Natural Resources © Queen's Printer for Ontario, 2013.

Client/Project  
 Suncor Energy  
 Adelaide Wind Project

Figure No.  
**1**

Title  
**Post-construction Monitoring  
 EEMP Turbine Subset**

W:\active\60960710\drawing\MXD\terrestrial\Post\_Con\_Monitoring\EEMP\_TurbineSubset\_20150417.mxd  
 Revised: 2015-04-17 By: dharvey



- Legend**
- Project Boundary
  - Amphibian Survey Stations
  - Project Components**
    - MET Tower
    - Turbine Location
    - Access Road
    - Collector Line
    - Substation Constructible Area
  - Existing Features**
    - Expressway / Highway
    - Road
    - Watercourse
    - Constructed Drain
    - Waterbody



- Notes**
1. Coordinate System: NAD 1983 UTM Zone 17N
  2. Base features produced under license with the Ontario Ministry of Natural Resources © Queen's Printer for Ontario, 2013.

January 2016  
160960710

Client/Project  
Suncor Energy  
Adelaide Wind Project

Figure No.  
**2**

Title

**Post-Construction Monitoring  
Amphibian Survey Stations**

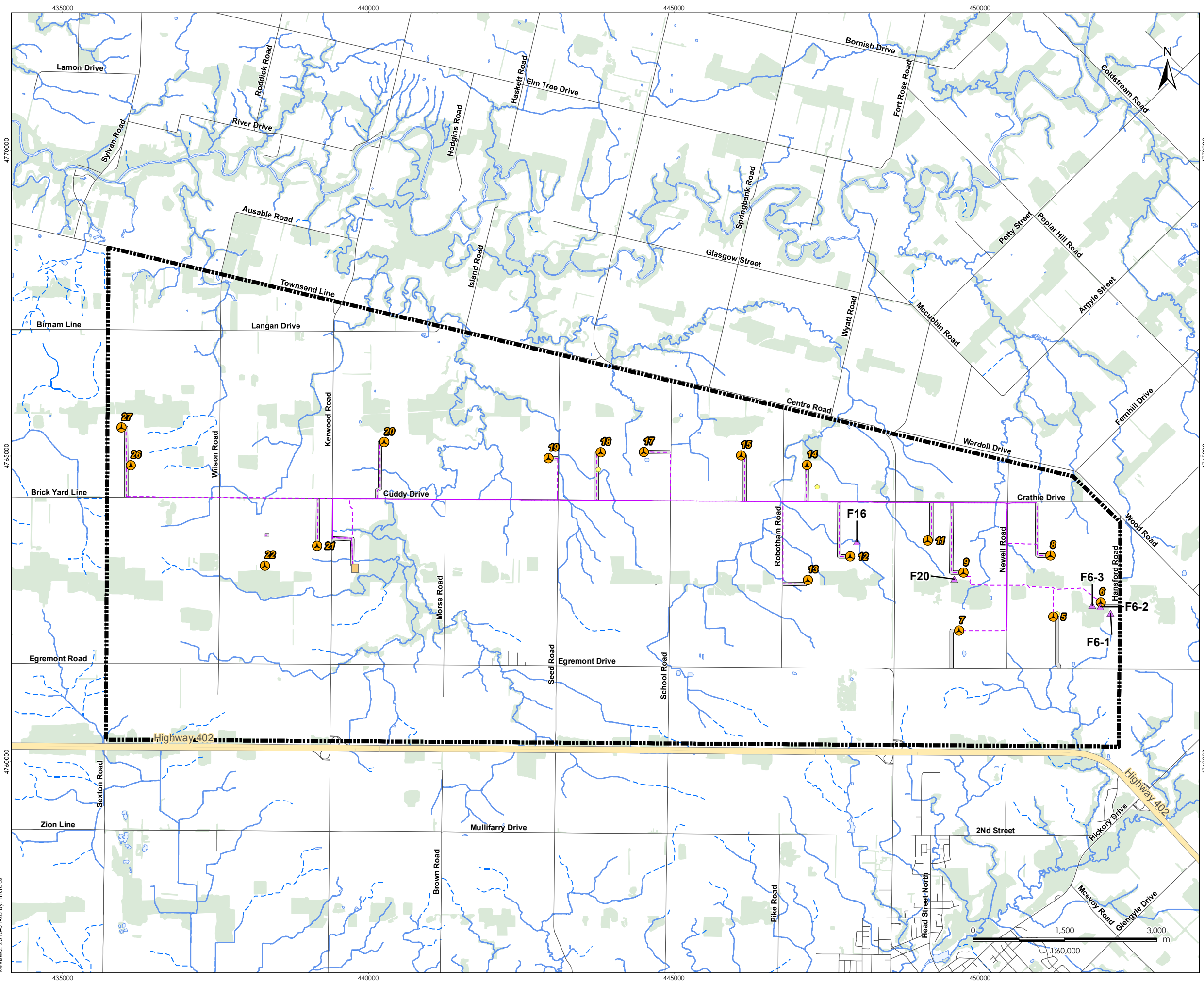

W:\active\60960710\drawing\MXD\Terrastical\Post\_Con\_Monitoring\2015\160960710\_Post\_Con\_Monitoring\_2015\_AmphibianSurveyStations\_20160128.mxd  
 Revised: 2016-01-28 By: mkrcaus

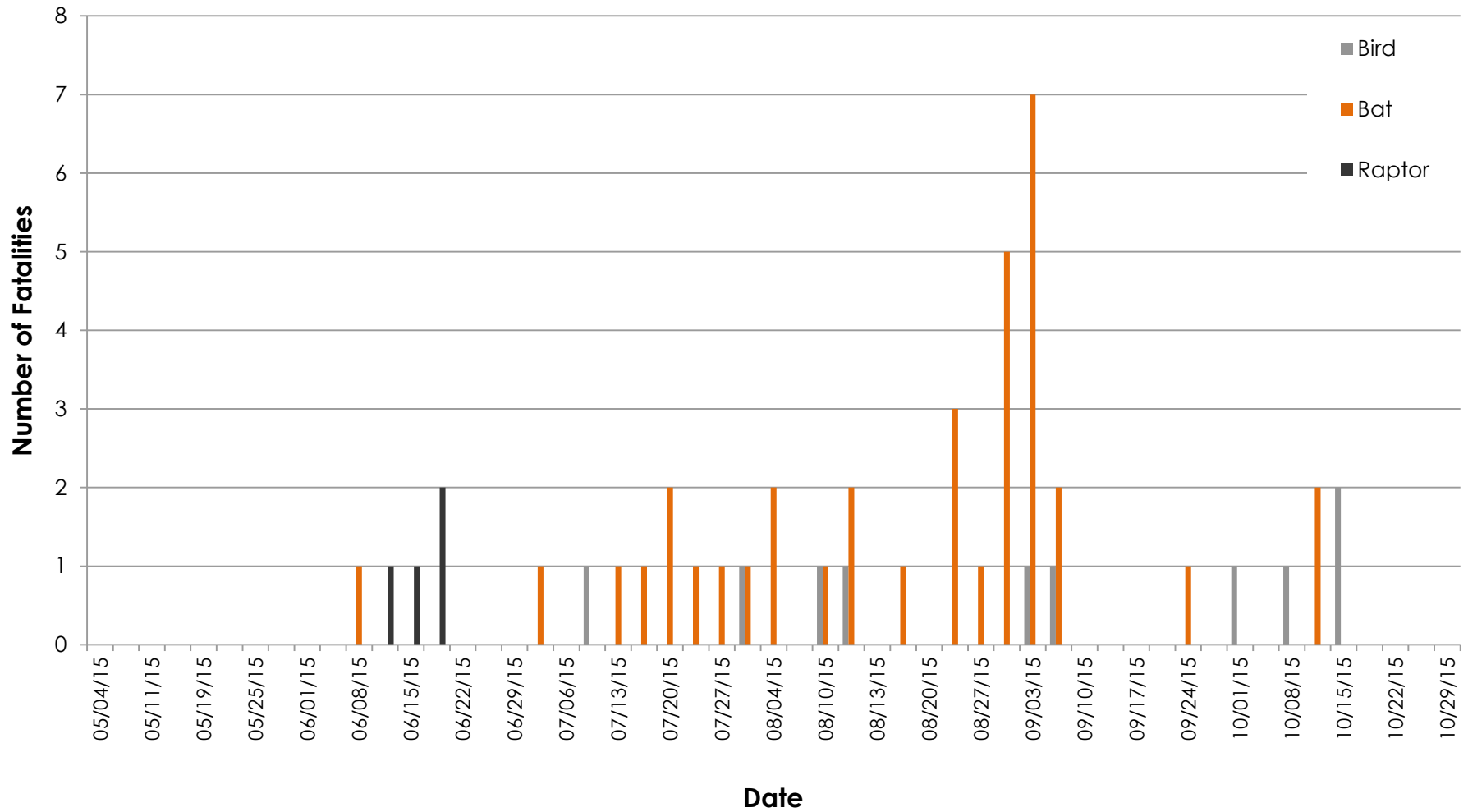

**Figure 3: Fatalities at the Adelaide Wind Energy Project by Date, 2015**

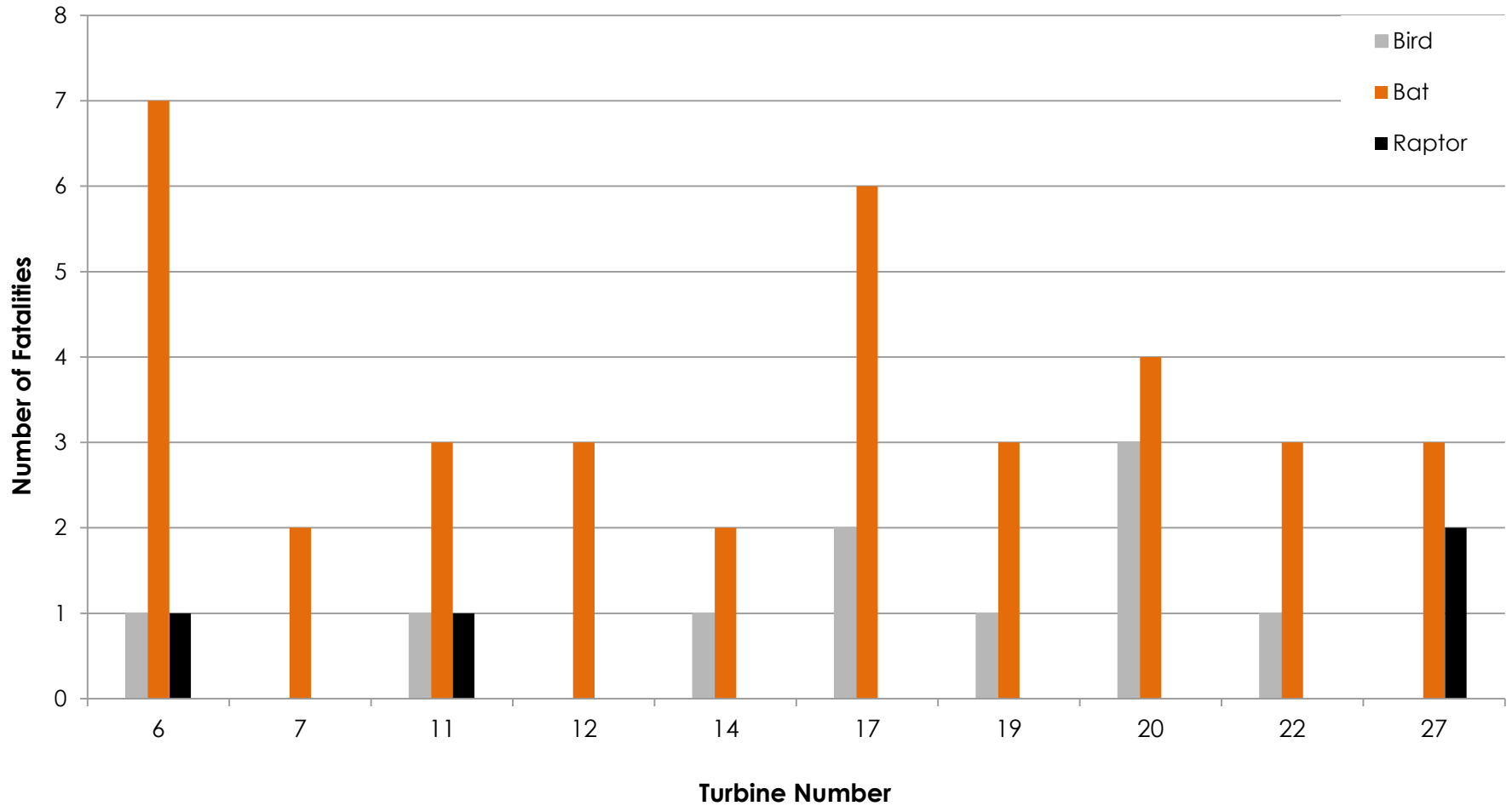

**Figure 4: Fatalities at the Adelaide Wind Energy Project by Turbine, 2015**

# **APPENDIX B: ENVIRONMENTAL EFFECTS MONITORING PLAN**



Ministry of Natural Resources  
Confirmation Letter  
Dated: July 31, 2012

**Ministry of  
Natural Resources**

Renewable Energy Operations Team  
P.O. Box 7000  
300 Water Street  
4<sup>th</sup> Floor, South Tower  
Peterborough, Ontario K9J 8M5

**Ministère des  
Richesses naturelles**



July 31, 2012  
Suncor Energy Products Inc.  
150 6<sup>th</sup> Avenue SW  
Calgary AB  
T2P 3E3

**RE: Natural Heritage Section of the EEMP for Suncor Energy Adelaide Wind Power Project**

Dear Christopher Scott:

MNR has reviewed the Natural Heritage section of the Environmental Effects Monitoring Plan (EEMP) for the Suncor Energy Adelaide Wind Power Project located within the Municipality of Adelaide Metcalfe, County of Middlesex, Ontario submitted July 27, 2012.

This letter confirms that the EEMP was prepared in respect of birds and bats in accordance with the Ministry of Natural Resources:

- *Birds and Bird Habitats: Guidelines for Wind Power Projects (2011)*
- *Bats and Bat Habitats: Guidelines for Wind Power Projects (2011)*

Post-construction monitoring for the Suncor Energy Adelaide Wind Power Project will also include the following if the results of the pre-construction monitoring surveys deem the natural features significant:

- waterfowl nesting area (Features 6 and 20)
- amphibian breeding habitat woodland (Features 6 and 20)
- amphibian breeding habitat wetland (Feature 16)
- marsh bird breeding habitat (Features 6, 16 and 20)
- shrub/early successional bird breeding habitat (Feature 13)

MNR expects the information contained in the natural heritage section of the EEMP to be considered in MOE'S Renewable Energy Approval decision, and if approved, be implemented by the applicant.

If you have any questions please contact me at [amy.cameron@ontario.ca](mailto:amy.cameron@ontario.ca) or 705-875-7481.

Sincerely,

A handwritten signature in blue ink that reads "Amy Cameron".

Amy Cameron  
Coordinator  
Renewable Energy Operations Team  
Southern Region, MNR

cc. Heather Riddell, Renewable Energy Planning Ecologist

cc. Mitch Wilson, Aylmer District Manager, MNR  
cc. Narren Santos, Environmental Assessment and Approvals Branch, MOE  
cc. Zeljko Romic, Environmental Assessment and Approvals Branch, MOE  
cc. Mark Kozak, Environmental Scientist, Stantec

Environmental Effects for  
Wildlife Monitoring Plan  
July 2012



**SUNCOR ENERGY**  
**ADELAIDE WIND ENERGY PROJECT**  
ENVIRONMENTAL EFFECTS MONITORING PLAN  
FOR WILDLIFE

File No.: 160960710  
July 2012

*Prepared for:*

**Suncor Energy Products Inc.**  
150 6th Avenue SW  
Calgary AB T2P 3E3

*Prepared by:*

**Stantec Consulting Ltd.**  
Suite 1 - 70 Southgate Drive  
Guelph ON N1G 4P5

## **Table of Contents**

---

<b>1.0 INTRODUCTION .....</b>	<b>1.1</b>
1.1 PROJECT OVERVIEW.....	1.1
1.2 REPORT REQUIREMENTS .....	1.1
<hr/>	
<b>2.0 POST-CONSTRUCTION MONITORING PROGRAM.....</b>	<b>2.1</b>
2.1 PURPOSE AND TIMING .....	2.1
2.2 PRIMARY DATA COLLECTION .....	2.1
2.2.1 Bird Mortality Monitoring .....	2.5
2.2.2 Bat Mortality Monitoring .....	2.6
2.2.3 Woodland Area-Sensitive Breeding Bird Surveys.....	2.7
2.2.4 Habitat Use Studies and Additional Habitat Disturbance Monitoring .....	2.8
2.3 REPORTING AND REVIEW OF RESULTS .....	2.12
<hr/>	
<b>3.0 ADAPTIVE MANAGEMENT PROGRAM.....</b>	<b>3.1</b>
3.1 MORTALITY MONITORING .....	3.1
3.1.1 Birds.....	3.1
3.1.2 Bats.....	3.2
3.1.3 Contingency Plan .....	3.3
3.1.3.1 Contingency Plan for Mass Mortality of Birds .....	3.3
3.1.3.2 Contingency Plan for Continued Significant Bat Mortality .....	3.3
<hr/>	
<b>4.0 BEST MANAGEMENT PRACTICES .....</b>	<b>4.1</b>
4.1 DATA MANAGEMENT.....	4.1
4.2 WHITE-NOSE SYNDROME .....	4.1
4.3 BAT TISSUE SAMPLES .....	4.1
<hr/>	
<b>5.0 CLOSURE .....</b>	<b>5.1</b>
<hr/>	
<b>6.0 REFERENCES .....</b>	<b>6.1</b>

## **1.0 Introduction**

---

### **1.1 PROJECT OVERVIEW**

Suncor Energy Products Inc. (“Suncor”) is proposing to develop the Suncor Energy Adelaide Wind Power Project (the Project) within the Municipality of Adelaide Metcalfe, County of Middlesex, Ontario. The proposed Project Location for this report includes all parts of the land in, on or over which the Project is proposed.

It is envisioned that the proposed Project may include up to 28 wind turbines with an estimated total nameplate capacity of up to 40 MW. The number of turbines will be dependent upon final selection of make and model of the wind turbine most appropriate for the proposed Project. The proposed Project would also include access roads, meteorological tower, electrical collector lines, and a substation which would connect the Project with the provincial high voltage transmission system via an existing transmission line that runs through the Project Boundary. Temporary components during construction may include storage and staging areas at the turbine locations, crane pads or mats, staging areas along access roads, delivery truck turnaround areas, and a central laydown area.

### **1.2 REPORT REQUIREMENTS**

This Environmental Effects Monitoring Plan (EEMP), which includes the Post-Construction Monitoring Plan is one component of the REA application for the Project, and has been prepared in accordance with O. Reg. 359/09, the Ontario Ministry of Natural Resources’ (MNR’s) *Approval and Permitting Requirements Document for Renewable Energy Projects* (September 2009), the MOE’s *Technical Guide to Renewable Energy Approvals*, MNR’s *Bats and Bat Habitats: Guidelines for Wind Power Projects* (July 2011) and MNR’s *Birds and Bird Habitats: Guidelines for Wind Power Projects* (December 2011).

As discussed in the Project’s **Natural Heritage Assessment and Environmental Impact Study (NHA/EIS)**, primary data were collected through bird and wildlife baseline studies in the Project Boundary. These data were augmented with secondary data from published and unpublished sources to generate a dataset from which to assess the potential effects of the Project.

The potential environmental effects to wildlife and wildlife habitat and associated mitigation measures, based upon this dataset, ornithological advice, and professional opinion, among other factors, are provided in **Section 5** of the NHA/EIS and summarized in **Table 1.1, Appendix A** of this EEMP. Additionally, wildlife and wildlife habitat post-construction monitoring commitments are summarized in **Section 5.3** of the NHA/EIS. These commitments provide the first step of confirming the predictions of the EIS and provide the basis from which actions contained in the EEMP may stem.

The purpose of this EEMP is to outline post-construction monitoring survey requirements for a three year period to address potential negative environmental effects for birds and bats, to assess the effectiveness of the proposed mitigation measures and to verify compliance of the Project with applicable provincial and federal legislation and guidelines. This monitoring plan provides details on the post-construction wildlife monitoring program for mortality monitoring of birds and bats and habitat disturbance monitoring for woodland area-sensitive breeding birds. It also identifies potential habitat disturbance monitoring activities for waterfowl nesting areas, marsh bird breeding habitat, shrub/early successional bird breeding habitat and amphibian woodland and wetland breeding habitat should habitat use studies to be conducted by Suncor result in features identified within 120 m of turbines in the **NHA/EIS** being considered significant wildlife habitat. Post-construction mortality monitoring should begin on May 1<sup>st</sup> of the year that the wind power project is fully operational. If full project commissioning is delayed, post-construction monitoring of a partially completed project should not be delayed for longer than 1 year. If the project is constructed in phases mortality monitoring for each phase should coincide with the commencement of operation of that phase.



## **2.0 Post-Construction Monitoring Program**

---

### **2.1 PURPOSE AND TIMING**

The purpose of the wildlife post-construction monitoring program is to identify performance objectives, assess the effectiveness of the proposed mitigation measures and to identify contingency measures that will be implemented if performance objectives cannot be met. Furthermore, any unanticipated potentially significant adverse environmental effects discovered during the post-construction monitoring program will be mitigated as described in **Section 3.0**. Post-construction monitoring for wildlife and wildlife habitat recommended in the **NHA/EIS** includes the following:

- *Bird and Bat Mortality monitoring*: twice weekly (3-4 day intervals) mortality monitoring at a minimum of 10 turbines (or 30% of turbines) beginning May 1 to October 31. Weekly monitoring for raptors at the 10 turbines will continue until November 30. Monitoring of all 28 turbines for raptor fatalities will take place once monthly from May through November. Monitoring will be conducted for a period of three years. Searcher efficiency and carcass removal trials will be conducted each year according to current guidance documents.

### **2.2 PRIMARY DATA COLLECTION**

To the extent possible, the same field personnel who carried out the pre-construction baseline studies will carry out the post-construction monitoring work to assist in standardizing the datasets. Wherever possible, a complete 50 m radius from each turbine base will be searched and data collection will be conducted by field personnel skilled at identifying birds and bats by sight. All carcasses found will be photographed and recorded/labelled with the following information; species, sex, date, time, location (UTM coordinates), carcass condition, searcher, injuries, ground cover, and distance and direction to nearest turbine.

Field data collection sheets will also include weather conditions such as wind speed and precipitation, ground cover visibility class, the estimated number of days since death, and condition of each carcass collected.

Although all reasonable effort will be made to conduct surveys as scheduled, surveys will not be conducted if weather (e.g. lightning, severe fog) presents safety concerns. Weather conditions will be noted when surveys were not conducted as scheduled, and every attempt will be made to complete the missed survey(s) as soon as possible.

The detailed monitoring methods, including duration, frequency and survey locations are discussed in the following sections.

The 10 turbines will be selected to provide representative coverage of the habitats and layout of the Project Boundary and will exclude any turbines where vegetation cover precludes searches (i.e. Visibility Classes 3 and 4 [MNR, 2011a]). MNR will be consulted to select the 10 turbines for post-construction monitoring. Where possible, the ground cover around turbines should be maintained at a low level in order to facilitate more accurate bird and bat mortality surveys. The search area of each turbine will be mapped into visibility classes according to the following table:

**Table 1: Ground Cover Visibility Classes (Ministry of Natural Resources, 2011)**

<b>% Vegetation Cover</b>	<b>Vegetation Height</b>	<b>Visibility Class</b>
≥90% bare ground	≤15%cm tall	Class 1 (Easy)
≥25% bare ground	≤15cm tall	Class 2 (Moderate)
≤25% bare ground	≤25% >30cm tall	Class 3 (Difficult)
Little or no bare ground	≥25% >30cm tall	Class 4 (Very Difficult)

*Portion Area Searched*

Most birds and bats will fall within 50 m of the turbine base (MNR 2011a) and therefore this distance represents the maximum recommended search area. This value will be used to determine the portion of area searched ( $P_s$ ). When the entire 50 m radius search area is searched,  $P_s$  will equal 100%. If portions of the 50 m radius search area are impossible or futile to search due to site conditions,  $P_s$  will be adjusted accordingly based on the searchers' ongoing estimates of the proportion of the search area that was physically searched. If feasible, a GPS will be used to delineate the search area and calculate the  $P_s$ .

The area searched will be determined for each turbine by mapping searchable areas on a grid (by visibility class) and counting the number of searched grid cells within 50 m. A map of the actual search area for each turbine searched and a description of areas deemed to be unsearchable due to vegetation height, type, slope, active cultivation, etc., will be provided in the mortality report and maps of the varying search areas will be made available to review agencies. The aggregate area of those cells will be divided by the total area within a 50 m radius circle to determine the percent area searched for that turbine ( $P_{s_x}$ , where x is the turbine number).

$$P_{s_x} = \frac{\text{actual area searched}}{\pi r^2}$$

The overall  $P_s$  for the facility will be calculated as the average of  $P_{s_1}$  through  $P_{s_{28}}$ .

Observed fatalities will be photographed, and the species, GPS coordinates, substrate, carcass conditions, possible injuries, sex (if possible) and distance and direction to the nearest turbine will be recorded along with the date, time and searcher. This approach to mortality monitoring will facilitate any potential correlation between mortality occurrences, turbine location, habitat/land use features, weather conditions and season.

### *Carcass Removal Trials*

Levels of carcass scavenging must be determined through carcass removal trials. In these trials, carcasses are planted around the wind turbines and monitored until they disappear or have completely decomposed (generally 2 weeks). Carcass removal trials will be conducted once a month (May-Oct) and will involve a minimum of 10 bird and bat carcasses as fresh as possible, with bat carcasses making up at least one third of the carcass removal trials and birds comprising another third, if available, or dark-coloured poultry chicks. If available, at least one raptor carcass will be used for some trials.

Marked test carcasses will be placed out singly at turbines and distributed across the Project Boundary before dusk using gloves and boots to avoid imparting human smell. These trials involve the distribution of carcasses in different substrate/habitat types and visibility classes being searched, at known locations at each wind turbine generator, followed by monitoring every 3-4 days in conjunction with carcass searches, checking to determine the rate of removal. The average carcass removal time is a factor in determining the estimated bird and bat mortality. Carcass removal trials are designed to correct for carcasses that are removed by predators before the search period. Proportions of carcasses remaining after each search interval are pooled to calculate the overall scavenger correction factor:

$$S_c = \frac{n_{\text{visit1}} + n_{\text{visit2}} + n_{\text{visit3}} + n_{\text{visit4}}}{n_{\text{visit0}} + n_{\text{visit1}} + n_{\text{visit2}} + n_{\text{visit3}}} \text{ where}$$

**S<sub>c</sub>** is the proportion of carcasses not removed by scavengers over the search period

**n<sub>visit0</sub>** is the total number of carcasses placed

**n<sub>visit1</sub> – n<sub>visit4</sub>** are the numbers of carcasses remaining on visits 1 through 4

### *Corrected Mortality Estimates*

In addition to total bird and bat mortalities observed, estimated mortality rates will also consider the results of searcher efficiency, carcass removal trials and portion area searched. There are numerous published and unpublished approaches to incorporating these corrective factors into an overall assessment of total bird and bat mortality. The minimum estimated mortality will be calculated as follows:

$$C = c / (S_{e0} \times S_c \times P_s), \text{ where}$$

**C** is the corrected number of bird or bat fatalities

**c** is the number of carcasses found

**S<sub>e0</sub>** is the weighted proportion of carcasses expected to be found by searchers (overall searcher efficiency)

**S<sub>c</sub>** is the proportion of carcasses not removed by scavengers over the search period

**P<sub>s</sub>** is the portion of the area searched.

### *Searcher Efficiency Trials*

Searcher efficiency trials require a known number of discreetly marked carcasses to be placed around a wind turbine. Searchers examine the wind turbine area, and the number of carcasses that they find is compared to the number of carcasses placed. Searcher efficiency trials will typically be conducted once in each of spring, summer and fall, but will be repeated if searchers change during the year. Searcher efficiency trials are designed to correct for carcasses that may be overlooked by surveyors during the survey periods. Searcher efficiency trials involve a “tester” that places bird and bat carcasses under turbines prior to the standard carcass searches to test the searcher’s detection rate. Each trial will consist of a minimum of 10 carcasses per searcher, per visibility class, per season and will coincide with the regular weekly carcass searches. No more than 3 trial carcasses would be placed at any one time. Trial carcasses will be placed randomly within the search area and the location will be recorded (UTM coordinates) to ensure easy retrieval by the “tester” at the end of the trial day. Trial carcasses will be marked with a unique identifying mark and should be as fresh as possible, with bat carcasses making up at least one third of the carcass removal trials and birds comprising another third, if available, or small brown mammals or dark-coloured poultry chicks.

Searcher efficiency (Se) is calculated for each searcher as follows:

$$Se = \frac{\text{number of test carcasses found}}{\text{number of test carcasses placed} - \text{number of test carcasses scavenged}}$$

A weighted average, or “overall Se”, will be calculated to account for varying survey effort between searchers. The overall Se will be calculated as follows:

$$Se_0 = Se_1(n_1/T) + Se_2(n_2/T) + Se_3(n_3/T) + Se_4(n_4/T)$$

where: **Se<sub>0</sub>** is the overall searcher efficiency;  
**Se<sub>1</sub> – Se<sub>4</sub>** are individual searcher efficiency ratings;  
**n<sub>1</sub> – n<sub>4</sub>** are number of turbines searched by each searcher  
**T** is the total number of turbines searched by all searchers.

## 2.2.1 Bird Mortality Monitoring

### Background

Data from wind projects currently operating in Ontario and around the world indicates that very low numbers of bird fatalities occur as result of wind power projects (MNR 2011a). Data from Ontario and the United States indicates that approximately two birds per year are killed by individual turbines, which is very low compared to other existing sources of human caused avian mortality (MNR 2011a). Birds can be killed through collisions with turbine blades and towers, guy wires, meteorological towers and maintenance vehicles. Mortality rates and patterns are affected by density and behavior of birds found in the area, the presence of landscape features such as ridges, valleys, peninsulas and shorelines and weather conditions.

### Monitoring

Post-construction bird mortality monitoring surveys may identify specific species, specific periods of high bird mortality or specific turbines/turbine groups linked to bird mortality. This information can be used to established protocols for operational mitigation and inform adaptive management. Bird mortality monitoring will be conducted according to MNR's *Birds and Bird Habitats: Guidelines for Wind Power Projects* (MNR, 2011a). **Table 1.2, Appendix A** of this EEMP summarizes the post-construction wildlife monitoring program for mortality monitoring of birds.

Mortality monitoring at 10 turbines (which is in excess of 30% of the total number of turbines contained within the Project) with minimally-vegetated ground cover (i.e., Visibility Classes 1 and 2 [MNR, 2011a]) within a 50 m radius using transects spaced 5.0 -6.0 m apart starting from the base of the wind turbine will be conducted twice-weekly (3-4 day intervals) beginning May 1 to October 31. Monitoring for raptors will continue at the 10 turbines until November 30. Monitoring of all 28 turbines for raptor fatalities will take place once monthly from May 1 through November 30. This will occur for a three year period.

Bird carcasses in good condition may be collected and stored in a freezer for future use in searcher efficiency and/or carcass removal trials. Searchers handling bird carcasses will take reasonable precautions (e.g. gloves, tools etc.) to protect their personal health. Bird carcasses will be placed in heavy-duty plastic bags and transported that day to a freezer, where they will be stored until required for the trials.

Authorization under the *Migratory Bird Convention Act, 1994* ("MBCA") will be required for handling carcasses of migratory birds. Likewise, carcasses of threatened or endangered species are covered under the *Endangered Species Act, 2007* ("ESA") or the federal *Species at Risk Act* ("SARA") and raptor carcasses are covered under the *Fish and Wildlife Conservation Act* ("FWCA"). Suncor and its agents will consult with the Ministry of Natural Resources ("MNR") and the Canadian Wildlife Service ("CWS") prior to commencing the field program to ensure

proper permits and/or procedure are in place to collect, possess and utilize wildlife carcasses for scientific purposes.

Other permits, approvals, authorizations, etc., are not likely to be required from the MNR or Environment Canada ("EC") to permit the monitoring activities contemplated in this Plan.

## **2.2.2 Bat Mortality Monitoring**

### **Background**

Bat mortality has been documented at wind power facilities in a variety of habitats across North America. Nearly every monitored wind power facility in the United States and Canada has reported bat mortality with minimum annual mortality varying from < 1 to 50 bat fatalities/turbine/year (MNR 2006). The majority of bat fatalities at wind power facilities occur in the late summer and fall, and the long-distance migratory bats (i.e., Hoary Bat, Eastern Red Bat, Silver-haired Bat) appear to be most vulnerable to collisions with moving turbine blades. Specific factors causing bat mortality and affecting species vulnerability to wind turbine mortality remain unclear, although recent evidence from Alberta suggests that air pressure differences in the blade vortices may contribute to bat mortality. Ontario specific data are relatively sparse at this time.

### **Monitoring**

In Ontario, the post-construction monitoring season for bats is based on bat activity patterns, covering spring activity through fall swarming and migration and is consistent with the post-construction monitoring season for birds; thus occurring from May 1- October 31. Bat mortality monitoring will be conducted according to MNR's *Bats and Bat Habitats: Guidelines for Wind Power Projects* (2011b). In general, the mortality monitoring requirements for bats will be captured in conjunction with bird mortality monitoring, as described in **Section 2.2.1. Table 1.2, Appendix A** of this EEMP summarizes the post-construction wildlife monitoring program for mortality monitoring of bats.

- Bat mortality monitoring will be conducted twice-weekly (3-4 day intervals) within minimally-vegetated portions (i.e., Visibility Classes 1 and 2 [MNR, 2011b]) of a 50 m search area radius from the base of 10 turbines beginning May 1 to October 31<sup>st</sup> for a three-year period in accordance with MNR guidelines. This time period includes the core season when resident and migratory bats are active. Bat mortality monitoring will be conducted in conjunction with other monitoring activities (birds) for efficiency.
- Searcher efficiency trials will be conducted seasonally and carcass removal trials will be conducted monthly between May 1 and October 31<sup>st</sup>. Searcher efficiency and carcass removal rates are known to be more variable for bats than for birds throughout the year and depending on habitat (in part due to the relative size of the species).

As with birds, trial carcasses will be discreetly marked so they can be identified as study carcasses. Each trial will consist of a minimum of 10 carcasses per searcher per visibility class (for searcher efficiency trials) or per trial (for scavenger removal trials). At least one-third of the trial carcasses should be bats.

Bat carcasses in good condition may be collected and stored in a freezer for future use in searcher efficiency and/or scavenger removal trials. Searchers handling bat carcasses will take reasonable precautions (e.g., gloves, tools etc.) to protect their personal health. All searchers will ensure they have updated rabies pre-exposure vaccinations. Biological material will be disposed of in a way to ensure that it does not pose a public or environmental health risk and in accordance with any applicable federal, provincial, and municipal laws.

### **2.2.3 Woodland Area-Sensitive Breeding Bird Surveys**

Woodland habitat in Features 1, 8, 11 and 20, located within 120 m of the Project Location, were considered significant wildlife habitat for woodland area-sensitive breeding birds, as described in **Sections 4.2.3.3 and 5.2.3.5** of the **NHA/EIS**. As Features 8 and 20 are located within 120 m of Turbines 22 and 9, respectively, a post-construction point count-based study will be implemented to assess any actual disturbance effects to woodland area-sensitive breeding bird species in these features. **Table 1.2, Appendix A** of this EEMP summarizes the post-construction wildlife monitoring program for habitat disturbance monitoring of woodland area-sensitive breeding birds.

Four pre-construction point count stations in woodland habitat will be established and surveyed during the pre-construction surveys. Two stations will be located in each of Features 8 and 20, with one station located within 120 m of the turbine, and the other station located approximately 200 m from the turbine and used as 'control' sites. Each of the surveys will include a ten-minute point count at each location, conducted during the breeding season (May 1 to July 31), for a minimum of three years. Each station should be surveyed a minimum of 3 times: once early in the season; once in mid-season; and, once later in the season with at least 10 days between surveys at a particular station. Point counts must be performed in the early morning, between dawn (one half hour before sunrise) and about 4 hours after sunrise. Surveys in late June and early July should usually be completed within 3 hours of sunrise. Surveys should be performed when the wind speed is 3 or less on the Beaufort scale and when there is no precipitation unless it is a light drizzle. Breeding pair density is a standard measure that will be used to compare among years or between control (> 120 m) and impact sites (< 120 m).

The woodland species observed will be compared to pre-construction conditions. Particular attention should be paid to those species identified as woodland area-sensitive indicator species as per the draft SWH Ecoregion 7E Criterion Schedule (MNR, 2012), including: Yellow-bellied Sapsucker, Red-breasted Nuthatch, Veery, Blue-headed Vireo, Northern Parula, Black-throated Green Warbler, Blackburnian Warbler, Black-throated Blue Warbler, Ovenbird, Scarlet Tanager, Winter Wren and Pileated Woodpecker; and, Special Concern species Cerulean Warbler and Canada Warbler.

MNR, along with the proponent and other relevant agencies, will collectively review the results of the post-construction monitoring to determine if an ecologically significant disturbance/avoidance effect is occurring, and whether such an effect is attributable to the wind turbines and not external factors. These discussions will determine if and when contingency

measures will be undertaken. The best available science and information should be considered when determining appropriate mitigation.

## **2.2.4 Habitat Use Studies and Additional Habitat Disturbance Monitoring**

### **2.2.4.1 Habitat Use Studies**

As per the requirements of Appendix D of the *Natural Heritage Assessment Guide for Renewable Energy Projects* (MNR, 2011a), habitat use studies must be undertaken to determine the actual use of the habitat prior to any construction activities occurring within 120 m of the habitat. In **Section 5.2** of the **NHA/EIS**, Suncor committed to undertake habitat use studies due to the location of proposed turbines within 120 m of candidate significant wildlife habitat for waterfowl nesting areas, marsh bird breeding habitat, shrub/early successional breeding bird habitat, amphibian woodland breeding habitat and amphibian wetland breeding habitat. Methodologies for undertaking the habitat use studies for candidate Significant Wildlife Habitat are described in the following sections.

#### **Waterfowl nesting areas**

As per the requirements of Appendix D of the *Natural Heritage Assessment Guide for Renewable Energy Projects* (MNR, 2011a), due to the location of proposed turbines within 120 m of Features 6 and 20, the proponent must commit to undertaking studies to determine the actual use of the habitat prior to any construction activities occurring within 120 m of the habitat.

Habitat use studies will be conducted according to “*Bird and Bird Habitats: Guidelines for Wind Power Projects*” (MNR, 2011c) and will include nesting studies to be completed during the breeding season (April-June). Specifically, nesting studies will consist of point counts at stations established in Features 6 and 20. Point counts will be performed in the early morning, between dawn (one half hour before sunrise) and about 4 hours after sunrise. Each station will be surveyed a minimum of 3 times, conducted early in the season, mid-season and later in the season, with at least 10 days between surveys at a particular station. Point counts should be performed when there is as little wind as possible (i.e., wind speeds should be 3 or less on the Beaufort scale) and should begin as early as possible in the morning (but not earlier than one half-hour before local sunrise), when the wind is generally calm so that windy conditions that may arise later in the morning can be avoided. Point counts should not be conducted if it is raining unless precipitation is not more than a light drizzle.

At each station, the surveyor will observe for ten minutes, recording all species seen or heard (including waterfowl), along with an estimate of the number of individuals of each species and the highest level of breeding evidence observed for each observation. Surveyors will estimate the distance to each bird using a scale of 0–50 m, 50–100 m and further than 100 m. Birds that move during the survey will be recorded in the closest distance category that they entered during the survey. Data that will be reported are the number of birds of each species detected in each distance band. Birds that fly over without stopping should be recorded separately as “fly-overs”. Additional information that will be recorded on the appropriate data forms include:



- Weather conditions (temperature, wind speed (on a Beaufort scale), % cloud cover, and presence of any precipitation should be recorded).
- Date and time of day.
- GPS coordinates of the point location.
- Name of the observer doing field work.

Given the size and characteristics of the waterfowl nesting areas in Features 6 and 20, it is anticipated that the habitats could potentially support some of the indicator waterfowl species identified in the Draft Significant Wildlife Habitat Ecoregion 7E Criterion Schedule, including: Black Duck, Wood Duck and Mallard.

### **Marsh bird breeding habitat**

As per the requirements of Appendix D of the *Natural Heritage Assessment Guide for Renewable Energy Projects* (MNR, 2011a), due to the location of a proposed turbines within 120 m of Features 6, 16 and 20, the proponent must commit to undertaking studies to determine the actual use of the habitat prior to any construction activities occurring within 120 m of the habitat. Habitat use studies will be conducted according to *“Bird and Bird Habitats: Guidelines for Wind Power Projects”* (MNR, 2011c) and will include breeding surveys in May/June when marsh bird species are actively nesting in wetland habitats. Specifically, nesting studies will consist of point counts at stations established in Features 6, 16 and 20. Point counts will be performed in the early morning, between dawn (one half hour before sunrise) and about 4 hours after sunrise. Each station will be surveyed a minimum of 3 times, conducted early in the season, mid-season and later in the season, with at least 10 days between surveys at a particular station. Point counts should be performed when there is as little wind as possible (i.e., wind speeds should be 3 or less on the Beaufort scale) and should begin as early as possible in the morning (but not earlier than one half-hour before local sunrise), when the wind is generally calm so that windy conditions that may arise later in the morning can be avoided. Point counts should not be conducted if it is raining unless precipitation is not more than a light drizzle.

At each station, the surveyor will observe for ten minutes, recording all species seen or heard (including waterfowl), along with an estimate of the number of individuals of each species and the highest level of breeding evidence observed for each observation. Surveyors will estimate the distance to each bird using a scale of 0–50 m, 50–100 m and further than 100 m. Birds that move during the survey will be recorded in the closest distance category that they entered during the survey. Data that will be reported are the number of birds of each species detected in each distance band. Birds that fly over without stopping should be recorded separately as “fly-overs”. Additional information that will be recorded on the appropriate data forms include:

- Weather conditions (temperature, wind speed (on a Beaufort scale), % cloud cover, and presence of any precipitation should be recorded).

- Date and time of day.
- GPS coordinates of the point location.
- Name of the observer doing field work.

Given the size and characteristics of Features 6, 16 and 20, it is anticipated that the habitats could potentially support some of the indicator marsh bird species identified in the Draft Significant Wildlife Habitat Ecoregion 7E Criterion Schedule, including: Virginia Rail, Sora and Sedge Wren in Feature 16; and, Green Heron in Features 6 and 20.

### **Shrub/early successional bird breeding habitat**

As per the requirements of Appendix D of the *Natural Heritage Assessment Guide for Renewable Energy Projects* (MNR, 2011a), due to the location of a proposed turbine within 120 m of Feature 13, the proponent must commit to undertaking studies to determine the actual use of the habitat prior to any construction activities occurring within 120 m of the habitat. Habitat use studies will be conducted according to *“Bird and Bird Habitats: Guidelines for Wind Power Projects”* (MNR, 2011c) and will include breeding surveys in spring and early summer (May-June) when birds are singing and defending their territories. Specifically, nesting studies will consist of point counts at stations established in Feature 13. Point counts will be performed in the early morning, between dawn (one half hour before sunrise) and about 4 hours after sunrise. Each station will be surveyed a minimum of 3 times, conducted early in the season, mid-season and later in the season, with at least 10 days between surveys at a particular station. Point counts should be performed when there is as little wind as possible (i.e., wind speeds should be 3 or less on the Beaufort scale) and should begin as early as possible in the morning (but not earlier than one half-hour before local sunrise), when the wind is generally calm so that windy conditions that may arise later in the morning can be avoided. Point counts should not be conducted if it is raining unless precipitation is not more than a light drizzle.

At each station, the surveyor will observe for ten minutes, recording all species seen or heard (including waterfowl), along with an estimate of the number of individuals of each species and the highest level of breeding evidence observed for each observation. Surveyors will estimate the distance to each bird using a scale of 0–50 m, 50–100 m and further than 100 m. Birds that move during the survey will be recorded in the closest distance category that they entered during the survey. Data that will be reported are the number of birds of each species detected in each distance band. Birds that fly over without stopping should be recorded separately as “fly-overs”. Additional information that will be recorded on the appropriate data forms include:

- Weather conditions (temperature, wind speed (on a Beaufort scale), % cloud cover, and presence of any precipitation should be recorded).
- Date and time of day.
- GPS coordinates of the point location.

- Name of the observer doing field work.

Given the size and characteristics of the habitat in Feature 13, it is anticipated that the habitats could potentially support some of the indicator shrub/early successional breeding bird species identified in the Draft Significant Wildlife Habitat Ecoregion 7E Criterion Schedule, including: Brown Thrasher, Black-billed Cuckoo, Eastern Towhee, Willow Flycatcher or Yellow-breasted Chat.

### **Amphibian woodland breeding habitat**

As per the requirements of Appendix D of the *Natural Heritage Assessment Guide for Renewable Energy Projects* (MNR, 2011a), due to the location of proposed access roads within 120 m of Features 6 and 20, the proponent must commit to undertaking studies to determine the actual use of the habitat prior to any construction activities occurring within 120 m of the habitats.

Habitat use surveys will be conducted according to the Marsh Monitoring Program, or “MMP” (BSC, 2003) protocol for breeding amphibians. According to the protocols set out in the MMP, three separate surveys will be completed for breeding amphibians. Based on the location of the Project Boundary (i.e., between the 43<sup>rd</sup> and 47<sup>th</sup> parallels), the first survey window is generally recognized as April 15 – 30, or when night-time air temperatures are consistently above 5°C. The second survey window is generally recognized as May 15 – 30, or when night-time air temperatures are consistently above 10°C. The third survey window is generally recognized as June 15 – 30, or when night-time air temperatures are consistently above 17°C. Surveys are time sensitive (conducted half an hour after sunset) as well as weather dependent. Surveys during the second and third windows will be repeated at the stations established during the first survey. Data will be recorded on Amphibian Call Survey Observation Forms.

Given the size and characteristics of the ponds in Features 6 and 20 and the historic ranges of frog species in the Project Boundary, it is anticipated that the habitats could potentially support some of the indicator amphibian species identified in the Draft Significant Wildlife Habitat Ecoregion 7E Criterion Schedule, including: Gray Treefrog; Spring Peeper; Western Chorus Frog; and, Wood Frog.

### **Amphibian wetland breeding habitat**

As per the requirements of Appendix D of the *Natural Heritage Assessment Guide for Renewable Energy Projects* (MNR, 2011a), due to the location of a proposed access road within 120 m of Feature 16, the proponent must commit to undertaking studies to determine the actual use of the habitat prior to any construction activities occurring within 120 m of the habitat.

Habitat use surveys will be conducted according to the Marsh Monitoring Program, or “MMP” (BSC, 2003) protocol for breeding amphibians. According to the protocols set out in the MMP, three separate surveys to be completed for breeding amphibians. Based on the location of the Project Boundary (i.e., between the 43<sup>rd</sup> and 47<sup>th</sup> parallels), the first survey window is generally

recognized as April 15 – 30, or when night-time air temperatures are consistently above 5°C. The second survey window is generally recognized as May 15 – 30, or when night-time air temperatures are consistently above 10°C. The third survey window is generally recognized as June 15 – 30, or when night-time air temperatures are consistently above 17°C. Surveys are time sensitive (conducted half an hour after sunset) as well as weather dependent. Surveys during the second and third windows will be repeated at the stations established during the first survey. Data will be recorded on Amphibian Call Survey Observation Forms.

Given the size and characteristics of the ponds in Feature 16 and the historic ranges of frog species in the Project Boundary, it is anticipated that the habitats could potentially support some of the indicator amphibian species identified in the Draft Significant Wildlife Habitat Ecoregion 7E Criterion Schedule, including: American Toad, Western Chorus Frog and Northern Leopard Frog.

#### **2.2.4.2 Additional Habitat Disturbance Monitoring**

Should the results of the habitat use studies result in the determination that these habitats are considered significant (as determined by Suncor or their agents and confirmed by MNR), the monitoring plan will be expanded to include additional post-construction habitat disturbance monitoring. If a determination of significance is made, the results of the habitat use studies will constitute the baseline for habitat disturbance monitoring. Methodologies implemented in undertaking the habitat use studies will be replicated during habitat disturbance monitoring, and undertaken as per the schedule presented in **Table 1.2, Appendix A**. If required, post-construction habitat disturbance monitoring will take place for a minimum of three (3) years for: waterfowl nesting areas; marsh bird breeding habitat; and, shrub/early successional breeding bird habitat, and one (1) year for: amphibian woodland breeding habitat; and, amphibian wetland breeding habitat.

### **2.3 Reporting and Review of Results**

Annual post-construction monitoring reports will summarize and analyze the results of all wildlife surveys. Reports will be submitted to the MOE and MNR within three months of the conclusion of the November mortality monitoring.

The monitoring program will be reassessed by MNR and Suncor at the end of each monitoring year. Pending the reassessment results, the program methods, frequencies, and duration may be reasonably modified to better reflect the findings.

## **3.0 Adaptive Management Program**

---

The adaptive management program described in this section outlines performance objectives, and contingency measures that will be implemented should the performance objectives not be met.

Contingency plans address immediate mitigation actions necessary in case of a significant bird or bat mortality event, or if mitigation actions fail. Contingency measures may include an adaptive management approach. An adaptive management program allows mitigation measures to be implemented in the event that unanticipated potentially significant adverse environmental effects are observed. Potentially significant adverse effects will be assessed through review of the annual report.

The following sections describe the procedures for notifications, reporting, and adaptive management for mortality and disturbance effects monitoring.

### **3.1 MORTALITY MONITORING**

All bird and bat mortality will be reported in the annual report submission. Mortality rate is expressed as the number of fatalities per turbine per year (e.g., from May 1 to November 30). Mortality of priority species in Bird Conservation Region (“BCR”) 13 and mortality of all species of conservation concern, such as raptors, marsh breeding birds, woodland area-sensitive breeding birds and shrub/early successional breeding bird species will be highlighted in the annual post-construction monitoring reports. A threshold approach will be used to identify and mitigate significant bird and bat mortality (potential negative environmental effects) resulting from the operation of wind turbines.

#### **3.1.1 Birds**

Post-construction mitigation, including operational controls, will be considered if annual mortality of birds exceeds any of the following thresholds defined by the MNR (2011a):

- 14 birds/turbine/year at individual turbines or turbine groups;
- 0.2 raptors/turbine/year (all raptors) across a wind power project; or
- 0.1 raptors of provincial conservation concern/turbine/year across a wind power project.

Or if bird mortality during a single mortality monitoring survey exceeds:

- 10 or more birds at any one turbine; or
- 33 or more birds (including raptors) at multiple turbines.

Mortality levels maintained below these thresholds are considered unlikely to affect bird populations (MNR 2011a).

Any and all observed mortality of species at risk (i.e., a species listed as Endangered, Threatened or Special Concern under Schedule 1 of the federal SARA or a species listed on the Species at Risk in Ontario list as Extirpated, Endangered, Threatened, or Special Concern under the provincial ESA) that occurs will be reported within 48 hours to MNR.

If with due consideration of seasonal abundance and species composition, annual mortality levels at turbines located outside 120 m of bird significant wildlife habitat (SWH) exceed the thresholds noted above, two years of subsequent scoped mortality and cause and effects monitoring will be conducted. Following scoped monitoring, post-construction mitigation (e.g., operational mitigation) and effectiveness monitoring may be required at individual turbines where a mortality effect has been identified or significant annual mortality persists (MNR 2011a).

If significant annual mortality persists, or occurs at turbines located within 120 m of bird SWH, immediate post-construction mitigation (including operational mitigation), as identified in the Environmental Impact Study, and 3 years of effectiveness monitoring may be required. Avoidance-disturbance effects monitoring will also be required. MNR will be engaged to initiate an appropriate response plan as set out in the MNR's Bird Guidelines (2011a). The response plan would include an analysis of the species, timing and distribution of fatalities to determine potential risk factors leading to mortality. The analysis may include an evaluation of the mortality data and/or behavioral studies to better refine when and where species are most at risk of collision. The results of this analysis will be used to develop operational mitigation measures, which will include the following

- Periodic shut-down of select turbines at specific times of year, when mortality risks to the affected bird species is particularly high (i.e., migration)<sup>1</sup>
- Blade feathering at specific times of year, when mortality risks to the affected bird species is particularly high (i.e., migration)
- Or alternate plan agreed to between Suncor and MNR

### **3.1.2 Bats**

Operational mitigation is required where annual post-construction mortality monitoring exceeds 10 bats/turbine/year (MNR, 2011).

This threshold of 10 bats/turbine/year has been determined based on bat mortality reported at wind power projects in Ontario and comparison with jurisdictions across North America.

---

<sup>1</sup> MNR 2011a

Operational mitigation to be implemented includes changing the wind turbine cut-in speed to 5.5 m/s (measured at hub height) or feathering of wind turbine blades when wind speeds are below 5.5 m/s.

The majority of bat mortalities from wind turbine operations occur during fall migration. Where post-construction monitoring indicates that annual bat mortality threshold of 10/bats/turbine/year has been exceeded, operational monitoring will be implemented across the wind power project from sunset to sunrise, from July 15-September 30 and will continue for the duration of the project. If site specific monitoring indicates a shifted peak mortality period (due to higher latitude projects), operational mitigation may be shifted to match the peak mortality, with mitigation maintained for a minimum of 10 weeks. Any shift in the operational mitigation period to match peak mortality will be determined in consultation with the MNR. Where post-construction mitigation is applied, an additional 3 years of effectiveness monitoring is required, as set out in the MNR's Bat Guidelines (2011).

### **3.1.3 Contingency Plan**

#### **3.1.3.1 Contingency Plan for Mass Mortality of Birds**

To date, there have been no recorded events of mass mortality of birds at wind farms in Ontario. The various post-construction monitoring projects in Ontario typically record between 0 to 2 bird fatalities at individual turbines during any one survey, with only a single record of 3 birds fatalities observed at one turbine during a single visit (Friesen, 2011). As such, the risk of a mass mortality event for birds is anticipated to be very low.

In the event of a mass mortality event, defined as 10 or more bird fatalities at any one turbine, or 33 or more bird fatalities (including raptors) at multiple turbines on a single survey, the following steps will be implemented:

1. MNR will be notified of the event within 48 hours and will be provided with any available details (e.g. species, number and distribution of turbines involved).
2. An emergency search of all turbines in the Project will be conducted as soon as feasibly possible to determine the extent and the distribution of the mortality event.
3. An analysis of the results of the emergency search will be completed to identify potential risk factors (e.g., weather conditions, proximity to natural heritage features) leading to the mortality event.
4. Based on the risk factors identified, additional mitigation and scoped monitoring recommendations will be developed in conjunction with MNR with the goal of avoiding future mortality events.

#### **3.1.3.2 Contingency Plan for Continued Significant Bat Mortality**

Additional mitigation measures may be implemented in the event of continued significant bat mortality (i.e., more than 10 bats/turbine/year) after the mitigation measures outlined in Section 3.1.2 have been implemented. Should the cut-in speed mitigation be implemented and the bat mortality thresholds continue to be exceeded, Suncor will work with the MNR to determine additional mitigation and scoped monitoring requirements.



## **4.0 Best Management Practices**

---

Suncor will include the following best management practices as part of the post-construction monitoring program (as outlined in MNR, 2011a and 2011b).

### **4.1 DATA MANAGEMENT**

All pre- and post-construction data, collected in accordance with MNR guidance and reported to the MOE, will be submitted to the joint Canadian Wildlife Service – Canadian Wind Energy Association – Bird Studies Canada – Ontario Ministry of Natural Resources Wind Power and Birds Monitoring Database.

### **4.2 WHITE-NOSE SYNDROME**

Carcasses of the following species found during bat mortality searches may be sent to the Canadian Cooperative Wildlife Health Centre for analysis of White-nose Syndrome and should not be used in carcass removal or searcher efficiency trials:

- Northern Long-eared Bat (*Myotis septentrionalis*)
- Little Brown Bat (*Myotis lucifugus*)
- Small-footed Bat (*Myotis leibii*)
- Tri-coloured Bat/Eastern Pipistrelle (*Perimyotis subflavus*)
- Big Brown Bat (*Eptesicus fuscus*)

### **4.3 BAT TISSUE SAMPLES**

Tissue samples from bat carcasses may be used in a number of DNA analyses to provide insight into population size and structure, as well as the geographic origin migrants. Suncor will contact the local MNR office prior to disposing bat carcasses, to determine if this type of research is occurring in the area.

## **5.0 Closure**

---

This Environmental Effects Monitoring Plan for the Suncor Energy Adelaide Wind Power Project has been prepared in accordance with O. Reg. 359/09, s. 23.1, the MNR's *Approval and Permitting Requirements Document for Renewable Energy Projects* (September 2009), the MOE's *Technical Guide to Renewable Energy Approvals*, MNR's *Bats and Bat Habitats: Guidelines for Wind Power Projects* (July 2011) and MNR's *Birds and Bird Habitats: Guidelines for Wind Power Projects* (December 2011).

Stantec Consulting Ltd. prepared this Environmental Effects Monitoring Plan for Suncor Energy Products Inc. for the Suncor Energy Adelaide Wind Power Project. Suncor is committed to implementing the appropriate protection and mitigation measures as they apply to the construction and operation of the proposed Project.

Respectfully submitted,  
**STANTEC CONSULTING LTD**

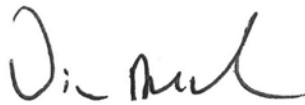

---

**Vince Deschamps**  
Senior Environmental Planner



---

**Mark Kozak**  
Senior Project Manager

2012-07-27\_adelaide\_eemp\_rev a\_fnl

## **6.0 References**

---

- Bird Studies Canada. 1994. Marsh Monitoring Program Protocol.
- Environment Canada. 1997. Amphibian Road Call-Counts Participants Manual.
- Environment Canada. 2007. Wind Turbines and Birds - A Guidance Document for Environmental Assessment. 46 pp.
- Friesen, L. 2011. No evidence of large-scale fatality events at Ontario wind projects in *Ontario Birds*, Volume 29, No. 3, December 2011: pages 149- 155.
- Ontario Ministry of Natural Resources. 2006. Wind Turbines and Bats: Bat Ecology Background Information and Literature Review of Impacts. December 2006.
- Ontario Ministry of Natural Resources. 2007. Guideline to Assist in the Review of Wind Power Proposals: Potential Impacts to Bats and Bat Habitats (Working Draft). 28 pp.
- Ontario Ministry of Natural Resources. 2009. Approval and Permitting Requirements Document for Renewable Energy Projects. 64 pp.
- Ontario Ministry of Natural Resources. 2010. Technical Bulletin Two: Guidance for preparing the Design and Operations Report (draft). 41 pp.
- Ontario Ministry of Natural Resources. 2011a. Birds And Bird Habitats: Guidelines For Wind Power Projects. 32 pp.
- Ontario Ministry of Natural Resources. 2011b. Bats And Bat Habitats: Guidelines For Wind Power Projects. 25 pp.
- Ontario Ministry of Natural Resources. 2012. Draft Significant Wildlife Habitat Ecoregion 7E Criterion schedule (Online). Available: <http://www.ebr.gov.on.ca/ERS-WEB-External/displaynoticecontent.do?noticeId=MTE1ODc5&statusId=MTczNDgy&language=en>
- Penna, M., H. Pottstock and N. Velasquez. 2005. Effect of natural and synthetic noise on evoked vocal responses in a frog of the temperate austral forest. *Animal Behaviour* 70: 639-651.
- Sun, W.C., and P.M. Narins. 2004. Anthropogenic sounds differentially affect amphibian call rate. *Biological Conservation* 121:419-427.

Table 1.2: Summary of Environmental Effects Monitoring Plan for Operation of the Suncor Adelaide Wind Energy Project								
Potential Negative Effect	Mitigation Strategy	Performance Objective	Monitoring Plan					Contingency Measures
			Methods	Location	Frequency	Rationale	Reporting	
<b>Mortality Monitoring for Birds and Bats</b>								
Direct mortality to birds through turbine collisions	Post-construction mortality monitoring program	Maintain mortality below thresholds	<p>Post-construction monitoring of mortality rates; carcass searches</p> <p>Methods are outlined in detail in this Environmental Effects Monitoring Plan</p>	<p>At 10 turbines (all birds) and 28 turbines (raptors)</p> <p>MNR will be consulted to determine location of turbines to be monitored.</p>	<p>Conducted twice-weekly (3-4 day intervals) at 10 turbines from May 1-October 31. Weekly monitoring for raptors will continue until November 30.</p> <p>Monitoring of all 28 turbines for raptor fatalities once a month from May 1-November 30.</p> <p>Monitoring to be conducted for three years.</p>	Bird and Bird Habitats: Guidelines for Wind Power Projects, 2011	<p>Annual Report will be submitted to MNR with the following anticipated dates:</p> <p>February 2015 February 2016 February 2017</p>	<p>Post-construction mitigation, including operational controls, will be considered if annual mortality of birds exceeds any of the following thresholds defined by the MNR (2011a):</p> <ul style="list-style-type: none"> <li>14 birds/turbine/year at individual turbines or turbine groups;</li> <li>0.2 raptors/turbine/year (all raptors) across a wind power project; or</li> <li>0.1 raptors of provincial conservation concern/turbine/year across a wind power project.</li> </ul> <p>Or if bird mortality during a single mortality monitoring survey exceeds:</p> <ul style="list-style-type: none"> <li>10 or more birds at any one turbine; or</li> <li>33 or more birds (including raptors) at multiple turbines.</li> </ul> <p>Mitigation may include operational controls, such as periodic shut-down on select turbines or blade feathering at specific times of the year, or alternate plan agreed to by Suncor/MNR.</p> <p>MNR will be consulted on contingency measures to be implemented.</p>
Direct mortality to bats through turbine collisions	Post-construction mortality monitoring program	Maintain mortality below thresholds	<p>Post-construction monitoring of mortality rates; carcass searches</p> <p>Methods are outlined in detail in this Environmental Effects Monitoring Plan</p>	<p>At 10 turbines</p> <p>MNR will be consulted to determine location of turbines to be monitored.</p>	<p>Conducted twice-weekly (3-4 day intervals) at 10 turbines from May 1-October 31.</p> <p>Monitoring to be conducted for three years.</p>	Bats and Bat Habitats: Guidelines for Wind Power Projects, 2011	<p>Annual Report will be submitted to MNR with the following anticipated dates:</p> <p>February 2015 February 2016 February 2017</p>	<p>Operational mitigation is required where annual post-construction mortality monitoring exceeds 10bats/turbine/year (MNR, 2011).</p> <p>Mitigation may include operational controls, such as periodic shut-down on select turbines or blade feathering at specific times of the year, or alternate plan agreed to by Suncor/MNR.</p> <p>MNR will be consulted on contingency measures to be implemented.</p>
<b>Disturbance Monitoring for Birds</b>								
Disturbance to waterfowl nesting areas during operation	Post-construction Disturbance Monitoring Program	MNR, along with the proponent and other relevant agencies, will	Point count survey and area searches using pre-	In Features 6 or 20, if they are determined	Three times during the spring breeding season	Breeding pair density is a standard measure	Annual Report will be submitted	Should performance objectives not be met:

**Table 1.2: Summary of Environmental Effects Monitoring Plan for Operation of the Suncor Adelaide Wind Energy Project**

Potential Negative Effect	Mitigation Strategy	Performance Objective	Monitoring Plan				Contingency Measures	
			Methods	Location	Frequency	Rationale		Reporting
(Feature 6 and 20)	<p>The breeding density of nesting waterfowl (combined and individual), within the habitat, will be monitored and compared to pre-construction conditions.</p> <p>In addition to density, the waterfowl nesting observed should be monitored and compared to pre-construction conditions. Particular attention should be paid to those species identified as waterfowl nesting area indicator species as per the draft SWH Ecoregion 7E Criterion Schedule (MNR, 2012), including: American Black Duck, Northern Pintail, Northern Shoveler, Gadwall, Blue-winged Teal, Green-winged Teal, Wood Duck, Hooded Merganser and Mallard.</p>	collectively review the results of the post-construction monitoring to determine if an ecologically significant disturbance/avoidance effect to nesting waterfowl is occurring, and whether such effect is attributed to the wind turbines and not external factors. These discussions will determine whether contingency measures will be undertaken.	<p>construction methods.</p> <p>Paired point counts extending from the base of wind turbine generators located within 120 m of waterfowl nesting areas with an equal number of paired point counts located more than 120 m from wind turbine generators in waterfowl nesting areas (i.e., control sites)</p> <p>Methods are outlined in detail in this Environmental Effects Monitoring Plan</p>	to be significant as a result of habitat use studies.*	(April-June), with at least 10 days between surveys, annually for three years.	that can be compared among years or between control/impact sites.	<p>to MNR with the following anticipated dates:                      February 2015                      February 2016                      February 2017</p>	<ul style="list-style-type: none"> <li>Compare declines to population trends noted through province or continent-wide breeding bird surveys</li> <li>develop additional studies to determine extent of disturbance effect</li> <li>investigate habitat management means to increase breeding density</li> </ul> <p>Additional monitoring and/or mitigation may be required where post-construction monitoring identifies ecologically significant disturbance/avoidance effects associated with waterfowl nesting areas. Mitigation techniques may include (but are not limited to) operational controls, such as periodic shut-down and/or blade feathering. Results will be reviewed collectively by the proponent, MNR and other relevant agencies to determine if and when additional monitoring and/or mitigation is required. The best available science and information should be considered when determining appropriate mitigation.</p> <p>MNR will be consulted on contingency measures to be implemented.</p>
<p>Disturbance to marsh breeding bird species during operation (Features 6, 16 and 20)</p>	<p>Post-construction Disturbance Monitoring Program</p> <p>The breeding density of marsh species (combined and individual), within the habitat, will be monitored and compared to pre-construction conditions.</p> <p>In addition to density, the marsh breeding species observed should be monitored and compared to pre-construction conditions. Particular attention should be paid to those species identified as marsh breeding</p>	<p>MNR, along with the proponent and other relevant agencies, will collectively review the results of the post-construction monitoring to determine if an ecologically significant disturbance/avoidance effect to marsh breeding birds is occurring, and whether such effect is attributed to the wind turbines and not external factors. These discussions will determine whether contingency measures will be undertaken.</p>	<p>Point count survey and area searches using pre-construction methods.</p> <p>Paired point counts extending from the base of wind turbine generators located within 120 m of marsh habitat with an equal number of paired point counts located more than 120 m from wind turbine generators in marsh habitat (i.e., control sites).</p> <p>Methods are outlined in detail in this Environmental Effects Monitoring Plan</p>	In Features 6, 16 or 20, if they are determined to be significant as a result of habitat use studies.*	Three times during the spring breeding season (May-June), with at least 10 days between surveys, annually for three years.	Breeding pair density is a standard measure that can be compared among years or between control/impact sites	<p>Annual Report will be submitted to MNR with the following anticipated dates:                      February 2015                      February 2016                      February 2017</p>	<p>Should performance objectives not be met:</p> <ul style="list-style-type: none"> <li>Compare declines to population trends noted through province or continent-wide breeding bird surveys</li> <li>develop additional studies to determine extent of disturbance effect</li> <li>investigate habitat management means to increase breeding density</li> </ul> <p>Additional monitoring and/or mitigation may be required where post-construction monitoring</p>

**Table 1.2: Summary of Environmental Effects Monitoring Plan for Operation of the Suncor Adelaide Wind Energy Project**

Potential Negative Effect	Mitigation Strategy	Performance Objective	Monitoring Plan					Contingency Measures
			Methods	Location	Frequency	Rationale	Reporting	
	habitat indicator species as per the draft SWH Ecoregion 7E Criterion Schedule (MNR, 2012), including: American Bittern, Virginia Rail, Sora, Common Moorhen, American Coot, Pied-billed Grebe, Marsh Wren, Sedge Wren, Common Loon, Green Heron, Trumpeter Swan; and, Special Concern species including Black Tern and Yellow Rail.							identifies ecologically significant disturbance/avoidance effects associated with marsh breeding bird habitat. Mitigation techniques may include (but are not limited to) operational controls, such as periodic shut-down and/or blade feathering. Results will be reviewed collectively by the proponent, MNR and other relevant agencies to determine if and when additional monitoring and/or mitigation is required. The best available science and information should be considered when determining appropriate mitigation.  MNR will be consulted on contingency measures to be implemented.
Disturbance to woodland area-sensitive breeding bird species during operation (Features 8 and 20)	<p>Post-construction Disturbance Monitoring Program</p> <p>The breeding density of woodland area-sensitive species (combined and individual), within the habitat, will be monitored and compared to pre-construction conditions.</p> <p>In addition to density, the woodland area-sensitive species observed should be monitored and compared to pre-construction conditions. Particular attention should be paid to those species identified as woodland area-sensitive indicator species as per the draft SWH Ecoregion 7E Criterion Schedule (MNR, 2012), including: Yellow-bellied Sapsucker, Red-breasted Nuthatch, Veery, Blue-headed Vireo, Northern Parula, Black-throated Green Warbler, Blackburnian Warbler, Black-throated Blue Warbler, Ovenbird, Scarlet Tanager, Winter Wren and Pileated Woodpecker; and, Special Concern species Cerulean Warbler and</p>	MNR, along with the proponent and other relevant agencies, will collectively review the results of the post-construction monitoring to determine if an ecologically significant disturbance/avoidance effect to woodland area-sensitive breeding birds is occurring, and whether such effect is attributed to the wind turbines and not external factors. These discussions will determine whether contingency measures will be undertaken.	<p>Point count survey and area searches using pre-construction methods.</p> <p>Paired point counts extending from the base of wind turbine generators located within 120 m of woodland area-sensitive habitat with an equal number of paired point counts located more than 120 m from wind turbine generators in woodland area-sensitive habitat (i.e., control sites).</p> <p>Methods are outlined in detail in this Environmental Effects Monitoring Plan</p>	In Features 8 and 20, as they are located within 120 m of Turbine 22 and 9, respectively.	Three times during the spring breeding season (May-June), with at least 10 days between surveys, annually for three years.	Breeding pair density is a standard measure that can be compared among years or between control/impact sites	<p>Annual Report will be submitted to MNR with the following anticipated dates: February 2015 February 2016 February 2017</p>	<p>Should performance objectives not be met:</p> <ul style="list-style-type: none"> <li>Compare declines to population trends noted through province or continent-wide breeding bird surveys</li> <li>develop additional studies to determine extent of disturbance effect</li> <li>investigate habitat management means to increase breeding density</li> </ul> <p>Additional monitoring and/or mitigation may be required where post-construction monitoring identifies ecologically significant disturbance/avoidance effects associated with woodland area-sensitive breeding bird habitat. Mitigation techniques may include (but are not limited to) operational controls, such as periodic shut-down and/or blade feathering. Results will be reviewed collectively by the proponent, MNR and other relevant agencies to determine if and when additional monitoring and/or mitigation is required. The best available science and information</p>

**Table 1.2: Summary of Environmental Effects Monitoring Plan for Operation of the Suncor Adelaide Wind Energy Project**

Potential Negative Effect	Mitigation Strategy	Performance Objective	Monitoring Plan					Contingency Measures
			Methods	Location	Frequency	Rationale	Reporting	
	Canada Warbler.							<p>should be considered when determining appropriate mitigation.</p> <p>MNR will be consulted on contingency measures to be implemented.</p>
Disturbance to shrub/early successional breeding bird species during operation (Feature 13)	<p>Post-construction Disturbance Monitoring Program</p> <p>The breeding density of shrubland species (combined and individual), within the habitat, will be monitored and compared to pre-construction conditions.</p> <p>In addition to density, the shrub/early successional species observed should be monitored and compared to pre-construction conditions. Particular attention should be paid to those species identified as shrub/early successional indicator species as per the draft SWH Ecoregion 7E Criterion Schedule (MNR, 2012), including: Brown Thrasher, Clay-coloured Sparrow, Field Sparrow, Black-billed Cuckoo, Eastern Towhee and Willow Flycatcher; and, Special Concern species including Yellow-breasted Chat and Golden-winged Warbler.</p>	<p>MNR, along with the proponent and other relevant agencies, will collectively review the results of the post-construction monitoring to determine if an ecologically significant disturbance/avoidance effect to shrub/early successional breeding birds is occurring, and whether such effect is attributed to the wind turbines and not external factors. These discussions will determine whether contingency measures will be undertaken.</p>	<p>Point count survey and area searches using pre-construction methods.</p> <p>Paired point counts extending from the base of wind turbine generators located within 120 m of shrub/early successional habitat with an equal number of paired point counts located more than 120 m from wind turbine generators in shrub/early successional habitat (i.e., control sites).</p> <p>Methods are outlined in detail in this Environmental Effects Monitoring Plan.</p>	In Feature 13, if it is determined to be significant as a result of habitat use studies.*	Three times during the spring breeding season (May-June), with at least 10 days between surveys, annually for three years.	Breeding pair density is a standard measure that can be compared among years or between control/impact sites	<p>Annual Report will be submitted to MNR with the following anticipated dates: February 2015 February 2016 February 2017</p>	<p>Should performance objectives not be met:</p> <ul style="list-style-type: none"> <li>Compare declines to population trends noted through province or continent-wide breeding bird surveys</li> <li>develop additional studies to determine extent of disturbance effect</li> <li>investigate habitat management means to increase breeding density</li> </ul> <p>Additional monitoring and/or mitigation may be required where post-construction monitoring identifies ecologically significant disturbance/avoidance effects associated with shrub/early successional breeding bird habitat. Mitigation techniques may include (but are not limited to) operational controls, such as periodic shut-down and/or blade feathering. Results will be reviewed collectively by the proponent, MNR and other relevant agencies to determine if and when additional monitoring and/or mitigation is required. The best available science and information should be considered when determining appropriate mitigation.</p> <p>MNR will be consulted on contingency measures to be implemented.</p>
<b>Disturbance Monitoring for Amphibians</b>								
Disturbance to amphibian woodland breeding habitat during operation (Features 6 and 20)	<p>Post-construction Disturbance Monitoring Program</p> <p>The breeding density of woodland species (combined</p>	<p>MNR, along with the proponent and other relevant agencies, will collectively review the results of the post-construction monitoring to determine if an ecologically</p>	<p>Call count surveys using pre-construction methods, based on Marsh Monitoring Program protocol.</p>	<p>2 count stations (one within 120m of project location and one more than 120m) in each of Features 6</p>	<p>Once in each of April 1-15, May 1-15 and June 1-15, for one year post-construction.</p>	<p>Presence of calling amphibians in significant wildlife habitat (with consideration for pre-</p>	<p>Report will be submitted to MNR with the following anticipated date:</p>	<p>Where post-construction monitoring identifies ecologically significant disturbance effects to amphibians the proponent, MNR and other relevant agencies will</p>

**Table 1.2: Summary of Environmental Effects Monitoring Plan for Operation of the Suncor Adelaide Wind Energy Project**

Potential Negative Effect	Mitigation Strategy	Performance Objective	Monitoring Plan					Contingency Measures
			Methods	Location	Frequency	Rationale	Reporting	
	<p>and individual), within the habitat, will be monitored and compared to pre-construction conditions.</p> <p>In addition to density, the species observed should be monitored and compared to pre-construction conditions. Particular attention should be paid to those species identified as amphibian breeding habitat (woodland) indicator species as per the draft SWH Ecoregion 7E Criterion Schedule (MNR, 2012), including: Gray Treefrog; Spring Peeper; Western Chorus Frog; and, Wood Frog.</p>	<p>significant disturbance/avoidance effect to woodland breeding amphibians is occurring, and whether such effect is attributed to the access roads and not external factors. These discussions will determine whether contingency measures will be undertaken.</p>	<p>Methods are outlined in detail in this Environmental Effects Monitoring Plan.</p>	<p>and 20, if they are determined to be significant as a result of habitat use studies.*</p>		<p>construction species presence) – specialized habitat for wildlife within 120 m of project location.</p>	<p>February 2015</p>	<p>determine if and when additional monitoring and/or mitigation is required and work together to develop a contingency plan. The best available science and information should be considered when determining appropriate mitigation.</p>
<p>Disturbance to amphibian wetland breeding habitat during operation (Feature 16)</p>	<p>Post-construction Disturbance Monitoring Program</p> <p>The breeding density of wetland species (combined and individual), within the habitat, will be monitored and compared to pre-construction conditions.</p> <p>In addition to density, the species observed should be monitored and compared to pre-construction conditions. Particular attention should be paid to those species identified as amphibian breeding habitat (wetland) indicator species as per the draft SWH Ecoregion 7E Criterion Schedule (MNR, 2012), including: American Toad; Gray Treefrog; Western Chorus Frog; Northern Leopard Frog; Pickerel Frog; Green Frog; Mink Frog; and, Bull Frog.</p>	<p>MNR, along with the proponent and other relevant agencies, will collectively review the results of the post-construction monitoring to determine if an ecologically significant disturbance/avoidance effect to wetland breeding amphibians is occurring, and whether such effect is attributed to the access roads and not external factors. These discussions will determine whether contingency measures will be undertaken.</p>	<p>Call count surveys using pre-construction methods, based on Marsh Monitoring Program protocol.</p> <p>Methods are outlined in detail in this Environmental Effects Monitoring Plan.</p>	<p>2 count stations (one within 120m of project location and one more than 120m) in Feature 16, if it is determined to be significant as a result of habitat use studies.*</p>	<p>Once in each of April 1-15, May 1-15 and June 1-15, for one year post-construction.</p>	<p>Presence of calling amphibians in significant wildlife habitat (with consideration for pre-construction species presence) – specialized habitat for wildlife within 120 m of project location.</p>	<p>Report will be submitted to MNR with the following anticipated date: February 2015</p>	<p>Where post-construction monitoring identifies ecologically significant disturbance effects to amphibians the proponent, MNR and other relevant agencies will determine if and when additional monitoring and/or mitigation is required and work together to develop a contingency plan. The best available science and information should be considered when determining appropriate mitigation.</p>

\* 3 years of post-construction monitoring is required for the habitats that are determined to be significant through habitat use studies/pre-construction monitoring surveys, with the exception of significant amphibian woodland and wetland breeding habitats, which require 1 year post-construction monitoring.



# APPENDIX C: RENEWAL ENERGY ACT APPROVAL

**RENEWABLE ENERGY APPROVAL**NUMBER 8279-9AUP2B  
Issue Date: December 11, 2013Suncor Energy Products Inc.  
150 6th Ave SW  
Calgary, Alberta T2P 3E3Project: North, East, and West of 2340 Egremont Drive, R.R. #5  
Location: Township of Adelaide-Metcalf, County of Middlesex

*You have applied in accordance with Section 47.4 of the Environmental Protection Act for approval to engage in a renewable energy project in respect of a Class 4 wind facility consisting of the following:*

- the construction, installation, operation, use and retiring of a Class 4 wind facility with a total name plate capacity of 40 megawatts.

*For the purpose of this renewable energy approval, the following definitions apply:*

1. "Acoustic Assessment Report" means the report included in the Application and entitled "Noise Assessment Report", dated July 8, 2013, prepared by HGC Engineering, signed by Ian R. Bonsma, P.Eng and Brian Howe P.Eng;
2. "Acoustic Audit - Emission" means an investigative procedure that is compliant with the IEC Standard 61400-11 and consisting of measurements and/or acoustic modelling of noise emissions produced by wind turbine generators, assessed to determine compliance with the manufacturer's noise (acoustic) equipment specifications and emission data of the wind turbine generators, included in the Acoustic Assessment Report;
3. "Acoustic Audit - Immission" means an investigative procedure consisting of measurements and/or acoustic modelling of all sources of noise emissions due to the operation of the Equipment, assessed to determine compliance with the Noise Performance Limits set out in this Approval;
4. "Acoustic Audit Report-Emission" means a report presenting the results of the Acoustic Audit - Emission;
5. "Acoustic Audit Report-Immission" means a report presenting the results of the Acoustic Audit - Immission;

6. "Acoustic Audit - Transformer Substation" means an investigative procedure that is compliant with the IEEE Standard C57.12.90 consisting of measurements and/or acoustic modelling of all noise sources comprising the transformer substation assessed to determine compliance with the Sound Power Level specification of the transformer substation described in the Acoustic Assessment Report.
7. "Acoustic Audit Report - Transformer Substation" means a report presenting the results of the Acoustic Audit - Transformer Substation.
8. "Acoustical Consultant" means a person currently active in the field of environmental acoustics and noise/vibration control, who is knowledgeable about Ministry noise guidelines and procedures and has a combination of formal university education, training and experience necessary to assess noise emissions from wind facilities;
9. "Act" means the *Environmental Protection Act*, R.S.O 1990, c.E.19, as amended;
10. "Adverse Effect" has the same meaning as in the Act;
11. "Application" means the application for a Renewable Energy Approval dated November 28, 2012, and signed by Christopher Scott, Project Developer, Suncor Energy Products Inc., and all supporting documentation submitted with the application, including amended documentation submitted up to the date this Approval is issued;
12. "Approval" means this Renewable Energy Approval issued in accordance with Section 47.4 of the Act, including any schedules to it;
13. "A-weighting" means the frequency weighting characteristic as specified in the International Electrotechnical Commission (IEC) Standard 61672, and intended to approximate the relative sensitivity of the normal human ear to different frequencies (pitches) of sound. It is denoted as "A";
14. "A-weighted Sound Pressure Level" means the Sound Pressure Level modified by application of an A-weighting network. It is measured in decibels, A-weighted, and denoted "dBA";
15. "Class 1 Area" means an area with an acoustical environment typical of a major population centre, where the background sound level is dominated by the activities of people, usually road traffic, often referred to as "urban hum";
16. "Class 2 Area" means an area with an acoustical environment that has qualities representative of both Class 1 and Class 3 Areas:
  1. sound levels characteristic of Class 1 during daytime (07:00 to 19:00 or to 23:00 hours);
  2. low evening and night background sound level defined by natural environment and infrequent human activity starting as early as 19:00 hours (19:00 or 23:00 to 07:00 hours);

- 
3. no clearly audible sound from stationary sources other than from those under impact assessment.
  17. "Class 3 Area" means a rural area with an acoustical environment that is dominated by natural sounds having little or no road traffic, such as the following:
    1. a small community with less than 1000 population;
    2. agricultural area;
    3. a rural recreational area such as a cottage or a resort area; or
    4. a wilderness area.
  18. "Company" means Suncor Energy Products Inc. and includes its successors and assignees;
  19. "Compliance Protocol for Wind Turbine Noise" means the Ministry document entitled, Compliance Protocol for Wind Turbine Noise, Guideline for Acoustic Assessment and Measurement, PIBS# 8540e;
  20. "Decibel" means a dimensionless measure of Sound Level or Sound Pressure Level, denoted as dB;
  21. "Director" means a person appointed in writing by the Minister of the Environment pursuant to section 5 of the Act as a Director for the purposes of section 47.5 of the Act;
  22. "District Manager" means the District Manager of the appropriate local district office of the Ministry where the Facility is geographically located;
  23. "Equipment" means the eighteen (18) wind turbine generators and one (1) transformer substation, identified in this Approval and as further described in the Application, to the extent approved by this Approval;
  24. "Equivalent Sound Level" is the value of the constant sound level which would result in exposure to the same total A-weighted energy as would the specified time-varying sound, if the constant sound level persisted over an equal time interval. It is denoted  $L_{eq}$  and is measured in dB A-weighting (dBA);
  25. "Facility" means the renewable energy generation facility, including the Equipment, as described in this Approval and as further described in the Application, to the extent approved by this Approval;
  26. "IEEE Standard C57.12.90" means the IEEE Standard Test Code for Liquid-Immersed Distribution, Power, and Regulating Transformers, 2010.
  27. "IEC Standard 61400-11" means the International Standard IEC Standard 61400-11, Wind turbine generator systems – Part 11: Acoustic noise measurement techniques, 2006;

28. "Independent Acoustical Consultant" means an Acoustical Consultant who is not representing the Company and was not involved in preparing the Acoustic Assessment Report. The Independent Acoustical Consultant shall not be retained by the Acoustical Consultant involved in the noise impact assessment;
29. "Ministry" means the ministry of the government of Ontario responsible for the Act and includes all officials, employees or other persons acting on its behalf;
30. "Noise Guidelines for Wind Farms" means the Ministry document entitled, "Noise Guidelines for Wind Farms - Interpretation for Applying MOE NPC Publications to Wind Power Generation Facilities", dated October 2008;
31. "Noise Receptor" has the same meaning as in O. Reg. 359/09;
32. "Publication NPC-233" means Ministry Publication NPC-233, "Information to be Submitted for Approval of Stationary Sources of Sound", October 1995;
33. "O. Reg. 359/09" means Ontario Regulation 359/09 "Renewable Energy Approvals under Part V.0.1 of the Act" made under the Act;
34. "Point of Reception" has the same meaning as in the Noise Guidelines for Wind Farms and is subject to the same qualifications described in that document;
35. "Sound Level" means the A-weighted Sound Pressure Level;
36. "Sound Level Limit" is the limiting value described in terms of the one hour A-weighted Equivalent Sound Level  $L_{eq}$ ;
37. "Sound Power Level" means ten times the logarithm to the base of 10 of the ratio of the sound power (Watts) of a noise source to standard reference power of  $10^{-12}$  Watts;
38. "Sound Pressure" means the instantaneous difference between the actual pressure and the average or barometric pressure at a given location. The unit of measurement is the micro pascal ( $\mu\text{Pa}$ );
39. "Sound Pressure Level" means twenty times the logarithm to the base 10 of the ratio of the effective pressure ( $\mu\text{Pa}$ ) of a sound to the reference pressure of  $20 \mu\text{Pa}$ ;
40. "UTM" means Universal Transverse Mercator coordinate system.

*You are hereby notified that this approval is issued to you subject to the terms and conditions outlined below:*

## **TERMS AND CONDITIONS**

### **A - GENERAL**

A1. The Company shall construct, install, use, operate, maintain and retire the Facility in accordance with the terms and conditions of this Approval and the Application and in accordance with the following schedules attached hereto:

SCHEDULE A - Facility Description

SCHEDULE B - Coordinates of the Equipment and Noise Specifications

SCHEDULE C - Noise Control Measures

A2. Where there is a conflict between a provision of this Approval and any document submitted by the Company, the conditions in this Approval shall take precedence. Where there is a conflict between one or more of the documents submitted by the Company, the document bearing the most recent date shall take precedence.

A3. The Company shall ensure a copy of this Approval is:

- (1) accessible, at all times, by Company staff operating the Facility and;
- (2) submitted to the clerk of each local municipality and upper-tier municipality in which the Facility is situated.

A4. If the Company has a publicly accessible website, the Company shall ensure that the Approval and the Application are posted on the Company's publicly accessible website within five (5) business days of receiving this Approval.

A5. The Company shall, at least six (6) months prior to the anticipated retirement date of the entire Facility, or part of the Facility, review its Decommissioning Plan Report to ensure that it is still accurate. If the Company determines that the Facility cannot be decommissioned in accordance with the Decommissioning Plan Report, the Company shall provide the Director and District Manager a written description of plans for the decommissioning of the Facility.

A6. The Facility shall be retired in accordance with the Decommissioning Plan Report and any directions provided by the Director or District Manager.

A7. The Company shall provide the Director and the District Manager at least ten (10) days written notice of the following:

- (1) the commencement of any construction or installation activities at the project location; and
- (2) the commencement of the operation of the Facility.

- A8. The Company shall, at least six (6) months prior to the anticipated retirement date of the entire Facility, or part of the Facility, contact the Ministry of Agriculture, Food and Rural Affairs to discuss its plans for the decommissioning of the Facility, and follow any directions provided by that ministry in respect of the Company's plans to restore the project location to its previous agricultural capacity.
- A9. As described in SCHEDULE A of the Approval, the Company shall not construct or operate more than eighteen (18) out of the twenty two (22) wind turbine generators identified in SCHEDULE B of the Approval;

**B - EXPIRY OF APPROVAL**

- B1. Construction and installation of the Facility must be completed within three (3) years of the later of:
- (1) the date this Approval is issued; or
  - (2) if there is a hearing or other litigation in respect of the issuance of this Approval, the date that this hearing or litigation is disposed of, including all appeals.
- B2. This Approval ceases to apply in respect of any portion of the Facility not constructed or installed before the later of the dates identified in Condition B1.

**C - NOISE PERFORMANCE LIMITS**

- C1. The Company shall ensure that:
- (1) the Sound Levels from the Equipment, at the Points of Reception identified in the Acoustic Assessment Report, comply with the Sound Level Limits set in the Noise Guidelines for Wind Farms, as applicable, and specifically as stated in the table below:

<b>Wind Speed (m/s) at 10 m height</b>	<b>4</b>	<b>5</b>	<b>6</b>	<b>7</b>	<b>8</b>	<b>9</b>	<b>10</b>
Sound Level Limits, dBA	40.0	40.0	40.0	43.0	45.0	49.0	51.0

- (2) the Equipment is constructed and installed at either of the following locations:
  - a) at the locations identified in SCHEDULE B of this Approval; or
  - b) at a location that does not vary by more than 10 metres from the locations identified in SCHEDULE B of this Approval and provided that,
    - i) the Equipment will comply with Condition C1 (1); and
    - ii) all setback prohibitions established under O. Reg. 359/09 are complied with.
- (3) the Equipment complies with the noise specifications set out in SCHEDULE B of this Approval.

- C2. If the Company determines that some or all of the Equipment cannot be constructed in accordance with Condition C1 (2), prior to the construction and installation of the Equipment in question, the Company shall apply to the Director for an amendment to the terms and conditions of the Approval.
- C3. Within three (3) months of the completion of the construction of the Facility, the Company shall submit to the Director a written confirmation signed by an individual who has the authority to bind the Company that the UTM coordinates of the “as constructed” Equipment comply with the requirements of Condition C1 (2).

#### **D – CONFIRMATION OF VACANT LOT NOISE RECEPTORS**

- D1. The locations identified in Table A5 of the Acoustic Assessment Report as “Point of Reception ID” numbers 52, 54, 57, 62, 64, 65, 148, 269, 508, 552, 553, 555, 556, 557, 560, 565, 567, 569, 571, 574, 578, 579, 583, 585, 587, 588, 591, 592, 595, 596, 598, 599, 604, 610, 612, 614, 615, 617, 619, 626, 628, 630, 631, 632, 633, 634, 639, 642, 646, 647, 650, 651, 652, 653, 654, 656, 657, 659, 660, 661, 664, 665, 666, 667, 668, 669, 670, 697, 699, 704, 705, 706, 707, 709, 717, 718, 728, 742, 743, 750, 751, 752, 753, 754, 755, PV\_442, PV\_443, PV\_444, PV\_461, V\_272, V\_276, V\_331, V\_341, V\_349, V\_350, V\_351, V\_355, V\_356, V\_357, V\_359, V\_360, V\_361, V\_382, V\_385, V\_387, V\_388, V\_389, V\_390, V\_400, V\_403, V\_420 and V\_460 are specified as Noise Receptors for the purposes of subsection 54 (1.1) of O. Reg. 359/09.

#### **E - ACOUSTIC AUDIT - IMMISSION**

- E1. The Company shall carry out an Acoustic Audit - Immission of the Sound Levels produced by the operation of the Equipment in accordance with the following:
- (1) the acoustic audit measurements shall be undertaken in accordance with Part D of the Compliance Protocol for Wind Turbine Noise;
  - (2) the acoustic audit measurements shall be performed by an Independent Acoustical Consultant at three (3) different Points of Reception that have been selected using the following criteria:
    - a) the Points of Reception should represent the location of the greatest predicted noise impact, i.e., the highest predicted Sound Level; and
    - b) the Points of Reception should be located in the direction of prevailing winds from the Facility;
  - (3) The acoustic audit measurements shall be performed on two (2) separate occasions;
  - (4) The acoustic audit measurements should be performed within a period of twelve (12) months.
- E2. The Company shall submit to the Director and the District Manager an Acoustic Audit Report - Immission, prepared by an Independent Acoustical Consultant, at the following points in time:



- (1) no later than nine (9) months after the commencement of the operation of the Facility for the first of the two (2) acoustic audit measurements at three (3) Points of Reception; and
- (2) no later than sixteen (16) months after the commencement of the operation of the Facility for the second of the two (2) acoustic audit measurements at three (3) Points of Reception.

E3. The Company shall carry out an Acoustic Audit - Transformer Substation and shall submit to the Director and the District Manager an Acoustic Audit Report – Transformer Substation prepared by an Independent Acoustical Consultant, in accordance with the IEEE Standard C57.12.90 and Ministry Publication NPC-233 and no later than six (6) months after the commencement of the operation of the Facility.

#### **F - ACOUSTIC AUDIT- EMISSION**

F1. The Company shall carry out an Acoustic Audit - Emission of the acoustic emissions produced by the operation of the wind turbine generators in accordance with the following:

- (1) the acoustic emission measurements shall be undertaken in accordance with the IEC Standard 61400-11;
- (2) the acoustic emission measurements shall be performed by an Independent Acoustical Consultant; and
- (3) the acoustic emission measurements shall be performed on two (2) of the wind turbine generators used in the Facility.

F2. The Company shall submit to the Director and the District Manager an Acoustic Audit Report-Emission, prepared in accordance with Section 9 of the IEC Standard 61400-11 by an Independent Acoustical Consultant, no later than nine (9) months after the commencement of the operation of the Facility.

#### **G - WATER TAKING ACTIVITIES**

G1. The Company shall not take more than 50,000 litres of water on any day by any means during the construction, installation, use, operation, maintenance and retiring of the Facility.

#### **H - SEWAGE WORKS OF THE TRANSFORMER SUBSTATION SPILL CONTAINMENT FACILITY**

H1. The Company shall design and construct a transformer substation oil spill containment facility which meets the following requirements:

- (1) the spill containment facility serving the transformer substation shall have a minimum volume equal to the volume of transformer oil and lubricants plus the volume equivalent to providing a minimum 24-hour duration, 50-year return storm capacity for the stormwater drainage area around the transformer under normal operating conditions. This containment area shall have:

- (a) an impervious floor with walls usually of reinforced concrete or impervious plastic liners, sloped toward an outlet / oil control device, allowing for a freeboard of 0.25 metres terminating approximately 0.30 metres above grade to prevent external stormwater flows from entering the facility. The facility shall have a minimum of 300mm layer of crushed stoned (19mm to 38mm in diameter) within, all as needed in accordance to site specific conditions and final design parameters; or
  - (b) a permeable floor with impervious plastic walls and around the transformer pad; equipped with subsurface drainage with a minimum 50mm diameter drain installed on a sand layer sloped toward an outlet for sample collection purposes; designed with an oil absorbent material on floor and walls, and allowing for a freeboard of 0.25 metres terminating approximately 0.30 metres above grade to prevent external stormwater flows from entering the facility. The facility's berm shall be designed as needed in accordance to site specific conditions and the facility shall have a minimum 300mm layer of crushed stoned (19mm to 38mm in diameter) on top of the system, as needed in accordance to site specific conditions and final design parameters.
- (2) the spill containment facility shall be equipped with an oil detection system; it also shall have a minimum of two (2) PVC pipes (or equivalent material) 50mm diameter to allow for visual inspection of water accumulation. One pipe has to be installed half way from the transformer pad to the vehicle access route;
  - (3) the spill containment facility shall have appropriate sewage appurtenances as necessary, such as but not limited to: sump, oil/grit separator, pumpout manhole, level controllers, floating oil sensors, etc., that allows for batch discharges or direct discharges and for proper implementation of the monitoring program described under Condition H4; and
  - (4) the Company shall have a qualified person on-site during construction to ensure that the system is installed in accordance with the approved design and specifications.

H2. The Company shall:

- (1) within six (6) months after the completion of the construction of the transformer substation spill containment facility, provide to the District Manager an engineering report and as-built design drawings of the sewage works for the spill containment facility and any stormwater management works required for it, signed and stamped by an independent Professional Engineer licensed in Ontario and competent in electrical and environmental engineering. The engineering report shall include the following:
  - (a) as-built drawings of the sewage works for the spill containment facility and any stormwater management works required for it;
  - (b) a written report signed by a qualified person confirming the following:
    - (i) on-site supervision during construction

- (ii) in case of a permeable floor systems: type of oil absorbent material used (for mineral-based transformer oil or vegetable-based transformer oil, make and material's specifications)
    - (ii) use of stormwater best management practices applied to prevent external surface water runoff from entering the spill containment facility, and
    - (iv) confirm adequacy of the installation in accordance with specifications.
  - (c) confirmation of the adequacy of the operating procedures and the emergency procedures manuals as it pertains to the installed sewage works.
  - (d) procedures to provide emergency response to the site in the form of pumping and clean-up equipment within 24 hours after an emergency has been identified. Such response shall be provided even under adverse weather conditions to prevent further danger of material loss to the environment.
- (2) as a minimum, the Company shall check the oil detection systems on a monthly basis and create a written record of the inspections;
  - (3) ensure that the effluent is essentially free of floating and settle-able solids and does not contain oil or any other substance in amounts sufficient to create a visible film, sheen or foam on the receiving waters;
  - (4) immediately identify and clean-up all losses of oil from the transformer;
  - (5) upon identification of oil in the spill containment facility, take immediate action to prevent the further occurrence of such loss;
  - (6) ensure that equipment and material for the containment, clean-up and disposal of oil and materials contaminated with oil are kept within easy access and in good repair for immediate use in the event of:
    - (a) loss of oil from the transformer,
    - (b) a spill within the meaning of Part X of the Act, or
    - (c) the identification of an abnormal amount of oil in the effluent.
  - (7) in the event of finding water accumulation in the PVC pipes (visual inspection) after 48 hrs of any storm event, the Company shall: (a) for impervious floors, inspect the sewage appurtenances that allow drainage of the concrete pit; or (b) for permeable systems, replace the oil absorbent material to ensure integrity of the system performance and design objectives.
  - (8) for permeable floor systems, the Company shall only use the type of oil specified in the design, i.e. mineral-based transformer oil or vegetable-based transformer oil. If a change is planned to modify the type of oil, the Company shall also change the type of the oil absorbent material and obtain approval from the Director to amend this Approval before any modification is implemented.

H3. The Company shall design, construct and operate the sewage works such that the concentration of the effluent parameter named in the table below does not exceed the maximum Concentration Objective shown for that parameter in the effluent, and shall comply with the following requirements:

<b>Effluent Parameters</b>	<b>Maximum Concentration Objective</b>
Oil and Grease	15mg/L

- (1) notify the District Manager as soon as reasonably possible of any exceedance of the maximum concentration objective set out in the table above;
- (2) take immediate action to identify the cause of the exceedance; and
- (3) take immediate action to prevent further exceedances.

H4. Upon commencement of the operation of the Facility, the Company shall establish and carry out the following monitoring program for the sewage works:

- (1) the Company shall collect and analyze the required set of samples at the sampling points listed in the table below in accordance with the measurement frequency and sample type specified for the effluent parameter, oil and grease, and create a written record of the monitoring:

<b>Effluent Parameters</b>	<b>Measurement Frequency and Sample Points</b>	<b>Sample Type</b>
Oil and Grease	Quarterly, i.e. four times over a year, relatively evenly spaced having a minimum two (2) of these samples taken within 48 hours after a 10mm rainfall event.	Grab

- (2) in the event of an exceedance of the maximum concentration objective set out in the table in Condition H3, the Company shall:
  - (a) increase the frequency of sampling to once per month, for each month that effluent discharge occurs, and
  - (b) provide the District Manager, on a monthly basis, with copies of the written record created for the monitoring until the District Manager provides written direction that monthly sampling and reporting is no longer required; and
- (3) if over a period of twenty-four (24) months of effluent monitoring under Condition H4, there are no exceedances of the maximum concentration set out in the table for Concentration Objective, the Company may reduce the measurement frequency of effluent monitoring to a frequency as the District Manager may specify in writing, provided that the new specified frequency is never less than annual.

- (4) the Company shall, in the event of an exceedance of the maximum Concentration Objective set out in the table under Condition H3, increase the frequency of sampling to once per month and provide the District Manager, with copies of the written record created for the monitoring until the District Manager provides written direction that monthly sampling is no longer required.

H5. The Company shall comply with the following methods and protocols for any sampling, analysis and recording undertaken in accordance with Condition H4:

- (1) Ministry of the Environment publication "Protocol for the Sampling and Analysis of Industrial/ Municipal Wastewater", January 1999, as amended from time to time by more recently published editions, and
- (2) the publication "Standard Methods for the Examination of Water and Wastewater", 21st edition, 2005, as amended from time to time by more recently published editions.

## **I – NATURAL HERITAGE**

### **General**

11. The Company shall implement the Environmental Effects Monitoring Plan for the Suncor Energy Adelaide Wind Power Project, titled Environmental Effects Monitoring Plan for Wildlife and Wildlife Habitat, dated July 2012, and the commitments made in the following reports and included in the Application, and in which the Company submitted to the Ministry of Natural Resources in order to comply with O. Reg. 359/09:
  - (1) *Suncor Energy Adelaide Wind Power Project Natural Heritage Assessment and Environmental Impact Study* dated July 2012 and prepared by Stantec Consulting Limited for Suncor Energy Products Inc.
  - (2) *Suncor Energy Adelaide Wind Project Addendum 1* letter report dated October 2012 prepared by Stantec Consulting Limited for Suncor Energy Products Inc.
  - (3) Memo titled *Suncor Energy Adelaide Minor Modifications* dated February 2013 and prepared by Stantec Consulting Limited for Suncor Energy Products Inc.
  - (4) Memo titled *Suncor Energy Adelaide Wind Power Project Modifications* dated November 5, 2013 and prepared by Stantec Consulting Limited for Suncor Energy Products Inc.
12. If the Company determines that it must deviate from either the Environmental Effects Monitoring Plan or the Environmental Impact Study and Addendum or minor modifications thereto, described in Condition I1, the Company shall contact the Ministry of Natural Resources and the Director, prior to making any changes to the Environmental Effects Monitoring Plan or the Environmental Impact Study and Addendum or minor modifications thereto, and follow any directions provided.

### **Post Construction Monitoring - Significant Wildlife Habitat**

- I3. The Company shall implement the post-construction monitoring described in the Environmental Effects Monitoring Plan and the Environmental Impact Study, described in Condition I1, including the following:
- (1) Disturbance monitoring of amphibian breeding habitat woodland for features 6 and 20,
  - (2) Disturbance monitoring of amphibian breeding habitat wetland for feature 16.

### **Post Construction Monitoring - Birds and Bats Mortality Monitoring**

- I4. The company shall implement the post-construction bird and bat mortality monitoring described in the Environmental Effects Monitoring Plan, described in Condition I1, at a minimum of 10 of 18 constructed turbines.

### **Thresholds and Mitigation**

- I5. The Company shall contact the Ministry of Natural Resources and the Director if any of the following bird and bat mortality thresholds, as stated in the Environmental Effects Monitoring Plan for the Suncor Energy Adelaide Wind Power Project described in Condition I1, are reached or exceeded:
- (1) 10 bats per turbine per year;
  - (2) 14 birds per turbine per year at individual turbines or turbine groups;
  - (3) 0.2 raptors per turbine per year (all raptors) across a wind power project;
  - (4) 0.1 raptors per turbine per year (provincially tracked raptors) across the wind power project;
  - (5) 10 or more birds at any one turbine during a single monitoring survey; or
  - (6) 33 or more birds (including raptors) at multiple turbines during a single monitoring survey.
- I6. If the bat mortality threshold described in Condition I5(1) is reached or exceeded, the Company shall:
- (1) implement operational mitigation measures consistent with those described in the Ministry of Natural Resources publication entitled "Bats and Bat Habitats: Guidelines for Wind Power Projects" dated July 2011, or in an amended version of the publication including:
    - (a) increase cut-in speed to 5.5 m/s or feather wind turbine blades when wind speeds are below 5.5 m/s between sunset and sunrise, from July 15 to September 30 at all turbines, for the operating life of the Facility; and
  - (2) implement an additional three (3) years of effectiveness monitoring.

- I7. If the bat mortality threshold described in Condition I5(1) is reached or exceeded after operational mitigation is implemented in accordance with Condition I6, the Company shall prepare and implement a contingency plan, in consultation with the Ministry of Natural Resources, to address mitigation actions which shall include additional mitigation and scoped monitoring requirements.
- I8. If either of the bird mortality thresholds described in Conditions I5(2) or I5(3) or I5(4) is reached or exceeded, the Company shall conduct two (2) years of subsequent scoped mortality monitoring and cause and effects monitoring. Following the completion of scoped monitoring, the Company shall implement operational mitigation for the operating life of the Facility, and effectiveness monitoring at individual turbines, for the first three (3) years following the implementation of mitigation.
- I9. If either of the bird mortality thresholds described in Conditions I5(5) or I5(6) is reached or exceeded, the Company shall prepare and implement a contingency plan to address immediate mitigation actions which shall include:
  - (1) periodic shut-down of select turbines;
  - (2) blade feathering at specific times of year; or
  - (3) an alternate plan agreed to between the Company and the Ministry of Natural Resources.
- I10. If either of the bird mortality thresholds described in Conditions I5(2) or I5(3) or I5(4) is reached or exceeded while monitoring is being implemented in accordance with Condition I8, or if either of the bird mortality thresholds described in Conditions I5(5) or I5(6) is reached or exceeded after mitigation is implemented in accordance with Condition I9, the Company shall contact the Ministry of Natural Resources and prepare and implement an appropriate response plan that shall include some or all of the following mitigation measures:
  - (1) increased reporting frequency to identify potential threshold exceedance;
  - (2) additional behavioural studies to determine factors affecting mortality rates;
  - (3) periodic shut-down of select turbines;
  - (4) blade feathering at specific times of year; or
  - (5) an alternate plan agreed to between the Company and the Ministry of Natural Resources.

### **Reporting and Review of Results**

- I11. The Company shall report, in writing, the results of the post-construction disturbance monitoring described in Conditions I3, to the Ministry of Natural Resources for three (3) years on an annual basis and within three (3) months of the end of each calendar year in which the monitoring took place.

- I12. The Company shall report, in writing, bird and bat mortality levels to the Ministry of Natural Resources for three (3) years on an annual basis and within three (3) months of the conclusion of the November mortality monitoring, with the exception of the following:
- (1) if either of the bird mortality thresholds described in Conditions I5(5) or I5(6) is reached or exceeded, the Company shall report the mortality event to the Ministry of Natural Resources within 48 hours of observation;
  - (2) for any and all mortality of species at risk (including a species listed on the Species at Risk in Ontario list as Extirpated, Endangered or Threatened under the provincial Endangered Species Act, 2007) that occurs, the Company shall report the mortality to the Ministry of Natural Resources within 24 hours of observation or the next business day;
  - (3) if the bat mortality threshold described in Condition I5(1) is reached or exceeded, the Company shall report mortality levels to the Ministry of Natural Resources for the additional three (3) years of monitoring described in Condition I6, on an annual basis and within three (3) months of the conclusion of the October mortality monitoring for each year;
  - (4) if either of the bird mortality thresholds described in Conditions I5(2) or I5(3) or I5(4) is reached or exceeded in the project area, the Company shall report mortality levels to the Ministry of Natural Resources for the additional two (2) years of cause and effects monitoring described in Condition I8, on an annual basis and within three (3) months of the conclusion of the November mortality monitoring for each year; and
  - (5) if the Company implements operational mitigation in accordance with Condition I8, the Company shall report mortality levels to the Ministry of Natural Resources for the three (3) years of subsequent effectiveness monitoring described in Condition I8, on an annual basis and within three (3) months of the conclusion of the November mortality monitoring for each year.

## **J - STORMWATER MANAGEMENT**

- J1. The Company shall employ best management practices for stormwater management and sediment and erosion control during construction, installation, use, operation, maintenance and retiring of the Facility, as described in the Application.

## **K - SURFACE WATER**

- K1. Within one year of the completion of the construction of the Facility, the Company must provide the District Manager, in writing, a description of post-construction surface water quality conditions and a written description of any additional remediation works required. The written description shall include surface water conditions during the freshet period occurrence in the first Spring following the construction of the Facility.



## **L - TRAFFIC MANAGEMENT PLANNING**

- L1. Within three (3) months of receiving this Approval, the Company shall prepare a Traffic Management Plan and provide it to the Township of Adelaide-Metcalf and the County of Middlesex.
- L2. Within three (3) months of having provided the Traffic Management Plan to the Township of Adelaide-Metcalf and the County of Middlesex, the Company shall make reasonable efforts to enter into a Road Users Agreement with the Township of Adelaide-Metcalf and the County of Middlesex.
- L3. If a Road Users Agreement has not been signed with the Township of Adelaide-Metcalf and the County of Middlesex within three (3) months of having provided the Traffic Management Plan to the Township of Adelaide-Metcalf and the County of Middlesex, the Company shall provide a written explanation to the Director as to why this has not occurred.

## **M - ARCHAEOLOGICAL RESOURCES**

- M1. The Company shall implement all of the recommendations, if any, for further archaeological fieldwork and for the protection of archaeological sites found in the consultant archaeologist's report included in the Application, and which the Company submitted to the Ministry of Tourism, Culture and Sport in order to comply with O. Reg. 359/09.
- M2. Should any previously undocumented archaeological resources be discovered, the Company shall:
  - (1) cease all alteration of the area in which the resources were discovered immediately;
  - (2) engage a consultant archaeologist to carry out the archaeological fieldwork necessary to further assess the area and to either protect and avoid or excavate any sites in the area in accordance with the *Ontario Heritage Act*, the regulations under that act and the Ministry of Tourism, Culture and Sport's *Standards and Guidelines for Consultant Archaeologists*; and
  - (3) notify the Director as soon as reasonably possible.

## **N - COMMUNITY LIAISON COMMITTEE**

- N1. Within three (3) months of receiving this Approval, the Company shall make reasonable efforts to establish a Community Liaison Committee. The Community Liaison Committee shall be a forum to exchange ideas and share concerns with interested residents and members of the public. The Community Liaison Committee shall be established by:
  - (1) publishing a notice in a newspaper with general circulation in each local municipality in which the project location is situated; and
  - (2) posting a notice on the Company's publicly accessible website, if the Company has a website;

to notify members of the public about the proposal for a Community Liaison Committee and invite residents living within a one (1) kilometer radius of the Facility that may have an interest in the Facility to participate on the Community Liaison Committee.

- N2. The Company may invite other members of stakeholders to participate in the Community Liaison Committee, including, but not limited to, local municipalities, local conservation authorities, Aboriginal communities, federal or provincial agencies, and local community groups.
- N3. The Community Liaison Committee shall consist of at least one Company representative who shall attend all meetings.
- N4. The purpose of the Community Liaison Committee shall be to:
- (1) act as a liaison facilitating two way communications between the Company and members of the public with respect to issues relating to the construction, installation, use, operation, maintenance and retirement of the Facility;
  - (2) provide a forum for the Company to provide regular updates on, and to discuss issues or concerns relating to, the construction, installation, use, operation, maintenance and retirement of the Facility with members of the public; and
  - (3) ensure that any issues or concerns resulting from the construction, installation, use, operation, maintenance and retirement of the Facility are discussed and communicated to the Company.
- N5. The Community Liaison Committee shall be deemed to be established on the day the Director is provided with written notice from the Company that representative Community Liaison Committee members have been chosen and a date for a first Community Liaison Committee meeting has been set.
- N6. If a Community Liaison Committee has not been established within three (3) months of receiving this Approval, the Company shall provide a written explanation to the Director as to why this has not occurred.
- N7. The Company shall ensure that the Community Liaison Committee operates for a minimum period of two (2) years from the day it is established. During this two (2) year period, the Company shall ensure that the Community Liaison Committee meets a minimum of two (2) times per year. At the end of this two (2) year period, the Company shall contact the Director to discuss the continued operation of the Community Liaison Committee.
- N8. The Company shall ensure that all Community Liaison Committee meetings are open to the general public.
- N9. The Company shall provide administrative support for the Community Liaison Committee including, at a minimum:
- (1) providing a meeting space for Community Liaison Committee meetings;

- (2) providing access to resources, such as a photocopier, stationery, and office supplies, so that the Community Liaison Committee can:
  - a) prepare and distribute meeting notices;
  - b) record and distribute minutes of each meeting; and
  - c) prepare reports about the Community Liaison Committee's activities.

N10. The Company shall submit any reports of the Community Liaison Committee to the Director and post it on the Company's publicly accessible website, if the Company has a website.

### **O - OPERATION AND MAINTENANCE**

- O1. Prior to the commencement of the operation of the Facility, the Company shall prepare a written manual for use by Company staff outlining the operating procedures and a maintenance program for the Equipment that includes as a minimum the following:
- (1) routine operating and maintenance procedures in accordance with good engineering practices and as recommended by the Equipment suppliers;
  - (2) emergency procedures;
  - (3) procedures for any record keeping activities relating to operation and maintenance of the Equipment; and
  - (4) all appropriate measures to minimize noise emissions from the Equipment.
- O2. The Company shall;
- (1) update, as required, the manual described in Condition O1; and
  - (2) make the manual described in Condition O1 available for review by the Ministry upon request.
- O3. The Company shall ensure that the Facility is operated and maintained in accordance with the Approval and the manual described in Condition O1.

### **P - RECORD CREATION AND RETENTION**

- P1. The Company shall create written records consisting of the following:
- (1) an operations log summarizing the operation and maintenance activities of the Facility;
  - (2) within the operations log, a summary of routine and Ministry inspections of the Facility; and

- (3) a record of any complaint alleging an Adverse Effect caused by the construction, installation, use, operation, maintenance or retirement of the Facility.

P2. A record described under Condition P1 (3) shall include:

- (1) a description of the complaint that includes as a minimum the following:
  - a) the date and time the complaint was made;
  - b) the name, address and contact information of the person who submitted the complaint;
- (2) a description of each incident to which the complaint relates that includes as a minimum the following:
  - a) the date and time of each incident;
  - b) the duration of each incident;
  - c) the wind speed and wind direction at the time of each incident;
  - d) the ID of the Equipment involved in each incident and its output at the time of each incident;
  - e) the location of the person who submitted the complaint at the time of each incident; and
- (3) a description of the measures taken to address the cause of each incident to which the complaint relates and to prevent a similar occurrence in the future.

P3. The Company shall retain, for a minimum of five (5) years from the date of their creation, all records described in Condition P1, and make these records available for review by the Ministry upon request.

## **Q - NOTIFICATION OF COMPLAINTS**

- Q1. The Company shall notify the District Manager of each complaint within two (2) business days of the receipt of the complaint.
- Q2. The Company shall provide the District Manager with the written records created under Condition P2 within eight (8) business days of the receipt of the complaint.
- Q3. If the Company receives a complaint related to groundwater, the Company shall contact the District Manager within one (1) business day of the receipt of the complaint to discuss appropriate measures to manage any potential groundwater issues.

## **R - CHANGE OF OWNERSHIP**

- R1. The Company shall notify the Director in writing, and forward a copy of the notification to the District Manager, within thirty (30) days of the occurrence of any of the following changes:
- (1) the ownership of the Facility;
  - (2) the operator of the Facility;
  - (3) the address of the Company;
  - (4) the partners, where the Company is or at any time becomes a partnership and a copy of the most recent declaration filed under the *Business Names Act*, R.S.O. 1990, c.B.17, as amended, shall be included in the notification; and
  - (5) the name of the corporation where the Company is or at any time becomes a corporation, other than a municipal corporation, and a copy of the most current information filed under the *Corporations Information Act*, R.S.O. 1990, c. C.39, as amended, shall be included in the notification.

## **S – ABORIGINAL CONSULTATION**

- S1. During the construction, installation, operation, use and retiring of the Facility, the Company shall:
- (1) create and maintain written records of any communications with Aboriginal communities; and
  - (2) make the written records available for review by the Ministry upon request.
- S2. The Company shall provide the following to interested Aboriginal communities:
- (1) updated project information, including the results of monitoring activities undertaken and copies of additional archaeological assessment reports that may be prepared; and
  - (2) updates on key steps in the construction, installation, operation, use and retirement phases of the Facility, including notice of the commencement of construction activities at the project location.
- S3. If an Aboriginal community requests a meeting to obtain information relating to the construction, installation, operation, use and retiring of the Facility, the Company shall make reasonable efforts to arrange and participate in such a meeting.
- S4. If any archaeological resources of Aboriginal origin are found during the construction of the Facility, the Company shall:
- (1) notify any Aboriginal community considered likely to be interested or which has expressed an interest in such finds; and,

- (2) if a meeting is requested by an Aboriginal community to discuss the archaeological find(s), make reasonable efforts to arrange and participate in such a meeting.

## **T – ENDANGERED SPECIES ACT REQUIREMENTS**

- T1. No construction or installation activities shall be commenced in areas at the project location that support habitat for Bobolink and Eastern Meadowlark until the Company has met all requirements under the *Endangered Species Act, 2007*.

## **SCHEDULE A**

### **Facility Description**

The Facility shall consist of the construction, installation, operation, use and retiring of the following:

- (a) a total of eighteen (18) out of twenty two (22) Siemens SWT-2.3-113 wind turbine generators each rated at a maximum of 2.221 megawatts (MW) generating output capacity with a maximum total name plate capacity of 40 megawatts (MW), each with a hub height of 99.5 metres above grade, and sited at the locations shown in SCHEDULE B, in accordance with Condition C1(2)(b); and
- (b) associated ancillary equipment, systems and technologies including one (1) 62 megavolt-ampere (MVA) transformer substation, on-site access roads, underground cabling and overhead distribution lines,

all in accordance with the Application.

**SCHEDULE B**

**Coordinates of the Equipment and Noise Specifications**

**Table B1:** Coordinates and Maximum Sound Power Levels of Wind Turbine Generators and Transformer Substation

(Coordinates of the Equipment below in UTM, Z17-NAD83 projection)

<b>Source ID</b>	<b>Maximum Sound Power Level (dBA)</b>	<b>Easting (metres)</b>	<b>Northing (metres)</b>	<b>Source Description</b>
WTG05	104.0	451,199	4,762,373	Wind Turbine (Siemens 2.3-113) 2.221MW, 99.5m hub height
WTG06	104.0	451,980	4,762,609	Wind Turbine (Siemens 2.3-113) 2.221MW, 99.5m hub height
WTG07	104.0	449,661	4,762,144	Wind Turbine (Siemens 2.3-113) 2.221MW, 99.5m hub height
WTG08	104.0	451,156	4,763,377	Wind Turbine (Siemens 2.3-113) 2.221MW, 99.5m hub height
WTG09	104.0	449,734	4,763,094	Wind Turbine (Siemens 2.3-113) 2.221MW, 99.5m hub height
WTG11	104.0	449,148	4,763,621	Wind Turbine (Siemens 2.3-113) 2.221MW, 99.5m hub height
WTG12	104.0	447,877	4,763,360	Wind Turbine (Siemens 2.3-113) 2.221MW, 99.5m hub height
WTG13	104.0	447,187	4,762,975	Wind Turbine (Siemens 2.3-113) 2.221MW, 99.5m hub height
WTG14	104.0	447,170	4,764,853	Wind Turbine (Siemens 2.3-113) 2.221MW, 99.5m hub height
WTG15	104.0	446,096	4,765,010	Wind Turbine (Siemens 2.3-113) 2.221MW, 99.5m hub height
WTG16	104.0	445,133	4,765,332	Wind Turbine (Siemens 2.3-113) 2.221MW, 99.5m hub height
WTG17	104.0	444,507	4,765,066	Wind Turbine (Siemens 2.3-113) 2.221MW, 99.5m hub height
WTG18	104.0	443,799	4,765,061	Wind Turbine (Siemens 2.3-113) 2.221MW, 99.5m hub height
WTG19	104.0	442,948	4,764,967	Wind Turbine (Siemens 2.3-113) 2.221MW, 99.5m hub height
WTG20	104.0	440,256	4,765,227	Wind Turbine (Siemens 2.3-113) 2.221MW, 99.5m hub height
WTG21	104.0	439,160	4,763,535	Wind Turbine (Siemens 2.3-113) 2.221MW, 99.5m hub height
WTG22	104.0	438,309	4,763,209	Wind Turbine (Siemens 2.3-113) 2.221MW, 99.5m hub height
WTG23	104.0	438,309	4,763,703	Wind Turbine (Siemens 2.3-113) 2.221MW, 99.5m hub height
WTG24	104.0	436,172	4,763,648	Wind Turbine (Siemens 2.3-113) 2.221MW, 99.5m hub height
WTG26	104.0	436,111	4,764,848	Wind Turbine (Siemens 2.3-113) 2.221MW, 99.5m hub height
WTG27	104.0	435,962	4,765,466	Wind Turbine (Siemens 2.3-113) 2.221MW, 99.5m hub height
WTG28	104.0	435,864	4,766,263	Wind Turbine (Siemens 2.3-113) 2.221MW, 99.5m hub height
TS1	100.8	439,770	4,763,131	Transformer Substation, 62 MVA, See Table B2



**Table B2: Maximum Sound Power Spectrum of Transformer Substation**

<b>Transformer Substation</b>	<b>1/1 Octave Band Centre Frequency (Hz)</b>							
	<b>63</b>	<b>125</b>	<b>250</b>	<b>500</b>	<b>1000</b>	<b>2000</b>	<b>4000</b>	<b>8000</b>
Sound Power Level (dB Lin)	103.4	105.4	100.4	100.4	94.4	89.4	84.4	77.4

**Note:** The Maximum Sound Power Level of Transformer Substation (Source ID "TS1") includes the applicable 5 dB tonal adjustment described in the Noise Guidelines for Wind Farms.

**SCHEDULE C**  
**Noise Control Measures**

**Acoustic Barrier**

One (1) 15 metres long, 6 metres high, L-shaped acoustic barrier, positioned as per Figure 3 of the Acoustic Assessment Report. The acoustic barrier shall be continuous without holes, gaps and other penetrations, and having a surface mass density of at least 20 kilograms per square metres.

*The reasons for the imposition of these terms and conditions are as follows:*

1. Conditions A1, A2 and A9 are included to ensure that the Facility is constructed, installed, used, operated, maintained and retired in the manner in which it was described for review and upon which Approval was granted. These conditions are also included to emphasize the precedence of conditions in the Approval and the practice that the Approval is based on the most current document, if several conflicting documents are submitted for review.
2. Conditions A3 and A4 are included to require the Company to provide information to the public and the local municipality.
3. Conditions A5 and A6 are included to ensure that final retirement of the Facility is completed in an aesthetically pleasing manner, in accordance with Ministry standards, and to ensure long-term protection of the health and safety of the public and the environment.
4. Condition A7 is included to require the Company to inform the Ministry of the commencement of activities related to the construction, installation and operation of the Facility.
5. Condition B is intended to limit the time period of the Approval.
6. Condition C1 is included to provide the minimum performance requirement considered necessary to prevent an Adverse Effect resulting from the operation of the Equipment and to ensure that the noise emissions from the Equipment will be in compliance with applicable limits set in the Noise Guidelines for Wind Farms.
7. Conditions A8, C2, C3 and D are included to ensure that the Equipment is constructed, installed, used, operated, maintained and retired in a way that meets the regulatory setback prohibitions set out in O. Reg. 359/09.
8. Conditions E and F are included to require the Company to gather accurate information so that the environmental noise impact and subsequent compliance with the Act, O. Reg. 359/09, the Noise Guidelines for Wind Farms and this Approval can be verified.
9. Conditions G, H, I, J, K, L and T are included to ensure that the Facility is constructed, installed, used, operated, maintained and retired in a way that does not result in an Adverse Effect or hazard to the natural environment or any persons.
10. Condition M is included to protect archaeological resources that may be found at the project location.
11. Condition N is included to ensure continued communication between the Company and the local residents.
12. Condition O is included to emphasize that the Equipment must be maintained and operated according to a procedure that will result in compliance with the Act, O. Reg. 359/09 and this Approval.

13. Condition P is included to require the Company to keep records and provide information to the Ministry so that compliance with the Act, O. Reg. 359/09 and this Approval can be verified.
14. Condition Q is included to ensure that any complaints regarding the construction, installation, use, operation, maintenance or retirement of the Facility are responded to in a timely and efficient manner.
15. Condition R is included to ensure that the Facility is operated under the corporate name which appears on the application form submitted for this Approval and to ensure that the Director is informed of any changes.
16. Condition S is included to ensure continued communication between the Company and interested Aboriginal communities.

### NOTICE REGARDING HEARINGS

*In accordance with Section 139 of the Environmental Protection Act, within 15 days after the service of this notice, you may by further written notice served upon the Director, the Environmental Review Tribunal and the Environmental Commissioner, require a hearing by the Tribunal.*

*In accordance with Section 47 of the Environmental Bill of Rights, 1993, the Environmental Commissioner will place notice of your request for a hearing on the Environmental Registry.*

*Section 142 of the Environmental Protection Act provides that the notice requiring the hearing shall state:*

1. The portions of the renewable energy approval or each term or condition in the renewable energy approval in respect of which the hearing is required, and;
2. The grounds on which you intend to rely at the hearing in relation to each portion appealed.

*The signed and dated notice requiring the hearing should also include:*

3. The name of the appellant;
4. The address of the appellant;
5. The renewable energy approval number;
6. The date of the renewable energy approval;
7. The name of the Director;
8. The municipality or municipalities within which the project is to be engaged in;

*This notice must be served upon:*

The Secretary\*  
Environmental Review Tribunal  
655 Bay Street, 15th Floor  
Toronto, Ontario  
M5G 1E5

AND

The Environmental Commissioner  
1075 Bay Street, 6th Floor  
Suite 605  
Toronto, Ontario  
M5S 2B1

AND

The Director  
Section 47.5, *Environmental Protection Act*  
Ministry of the Environment  
2 St. Clair Avenue West, Floor 12A  
Toronto, Ontario  
M4V 1L5

**\* Further information on the Environmental Review Tribunal's requirements for an appeal can be obtained directly from the Tribunal at: Tel: (416) 314-4600, Fax: (416) 314-4506 or [www.ert.gov.on.ca](http://www.ert.gov.on.ca)**

*Under Section 142.1 of the Environmental Protection Act, residents of Ontario may require a hearing by the Environmental Review Tribunal within 15 days after the day on which notice of this decision is published in the Environmental Registry. By accessing the Environmental Registry at [www.ebr.gov.on.ca](http://www.ebr.gov.on.ca), you can determine when this period ends.*

*Approval for the above noted renewable energy project is issued to you under Section 47.5 of the Environmental Protection Act subject to the terms and conditions outlined above.*

DATED AT TORONTO this 11th day of December, 2013



---

Vic Schroter, P.Eng.  
Director  
Section 47.5, *Environmental Protection Act*

NC/

c: District Manager, MOE London - District  
Mark Kozak, Stantec Consulting Inc.

# **APPENDIX D: TURBINE SELECTION CORRESPONDENCE**

**From:** [Taylor, Andrew](#)  
**To:** [Straus, Melissa](#)  
**Subject:** FW: Adelaide Wind Power Facility - Post-construction Monitoring  
**Date:** Thursday, January 07, 2016 9:48:49 AM  
**Attachments:** [160960710\\_Post\\_Con\\_Monitoring\\_EEMP\\_TurbineSubset\\_20150417.pdf](#)

---

---

**From:** Taylor, Andrew  
**Sent:** Wednesday, April 22, 2015 12:47 PM  
**To:** 'Jim.beal@ontario.ca'  
**Cc:** Kozak, Mark  
**Subject:** Adelaide Wind Power Facility - Post-construction Monitoring

Good afternoon Jim,

I'm email to inform MNRF that Stantec has been retained by Suncor to complete the EEMP monitoring for the Adelaide Wind Power Facility. The EEMP monitoring includes three years of mortality monitoring and one year of disturbance monitoring for SWH for amphibians.

For your information, I've attached a map of the subset of turbines (10 out of 18 turbines) Stantec has selected for the EEMP monitoring. There was no SWH for birds or bats at this project. As such, the subset was selected to be evenly distributed across the Project. Half the subset of turbines are within 120m of natural features (woodland and wetlands) and half more than 120m from natural features. This 50:50 ratio is representative of the Project as a whole. If you have any questions or comments regard the selected turbine subset, please let me know.

Regards,  
Andrew

**Andrew Taylor**

Senior Ecologist  
Stantec  
70 Southgate Drive, Suite 1 Guelph ON N1G 4P5  
Phone: (519) 836-6966 ext 222  
Cell: (519) 820-6149  
Fax: (519) 836-2493  
[andrew.taylor@stantec.com](mailto:andrew.taylor@stantec.com)

The content of this email is the confidential property of Stantec and should not be copied, modified, retransmitted, or used for any purpose except with Stantec's written authorization. If you are not the intended recipient, please delete all copies and notify us immediately.

 Please consider the environment before printing this email.

## **APPENDIX E: TABLES**



# ADELAIDE WIND POWER PROJECT: YEAR 1 POST-CONSTRUCTION WILDLIFE MONITORING REPORT (2015)

Appendix E - Tables  
February 17, 2017

**Table 2.1: Categories of Carcass Condition**

Code	Category	Description
I	Injured.	Individual still alive.
F	Fresh	Freshly dead with little or no decay or scavenging by insects; estimated 1 to 2 days.
E	Early decomposition	Recently dead but with early signs of decay or scavenging by insects; estimated 3 to 5 days.
M	Moderate decomposition	Noticeable signs of decay or scavenging by insects; estimated 6 to 6 days.
A	Advanced decomposition	Decomposed carcass, barely recognizable or not recognizable to species; estimated more than 7 days.
C	Complete decomposition	Residual remains, such as feathers, bones, other scraps of tissue.
S	Scavenged	Carcass is not intact.

**Table 2.2: Categories of Visibility Class**

Class	% Vegetation Cover	Vegetation Height
Class 1 (Easy)	≥ 90% bare ground	≤ 15cm tall
Class 2 (Moderate)	≥ 25% bare ground	≤ 15 cm tall
Class 3 (Difficult)	≤ 25% bare ground	≤ 25% > 30cm tall
Class 4 (Very difficult)	Little to no bare ground	≥ 25% > 30cm tall

**Table 2.3: Adelaide Wind Energy Project Disturbance Monitoring Field Survey Record, 2015**

Survey Date	Survey Type	Completed By	Time	Weather Conditions*
April 29, 2015	Amphibians	M. Straus and A. Corrigan	20:45-22:15	10°C, 2 wind, 20% cloud cover, no precipitation, no rain in the last 24hrs
May 25, 2015	Amphibians	M. Straus and B. Miller	20:00-21:15	22°C, 3-4 wind, 75% cloud cover, no precipitation, no rain in the last 24hrs
June 22, 2015	Amphibians	M. Straus and B. Miller	21:30-22:30	20°C, 4 wind, 50% cloud cover, no precipitation, rain in the last 24hrs

\* Wind conditions expressed using Beaufort Scale:

0 – calm, <2km/hr 2 – light, 7-12 km/hr 4 – moderate, 20-30 km/hr 6 – strong, 41-51 km/hr  
1 – light, 2-6 km/hr 3 – moderate, 13-19 km/hr 5 – fresh, 31-40 km/hr

**ADELAIDE WIND POWER PROJECT: YEAR 1 POST-CONSTRUCTION WILDLIFE MONITORING REPORT (2015)**

Appendix E - Tables  
February 17, 2017

**Table 3.1: Searcher Efficiency Trials at the Adelaide Wind Energy Project, 2015**

Month	Searcher	Placed	Scavenged	Found	Individual SE ( $Se_x$ )
Spring	KE	24	3	13	0.62
	AC	23	2	18	0.86
Summer	KE	22	2	14	0.70
Fall	KE	24	2	14	0.64
	AC	12	1	10	0.91

KE- Ken Edwards  
AC- Anna Corrigan

**Table 3.2: Weighted Search Efficiencies at the Adelaide Wind Energy Project, 2015**

Surveyor	Individual SE ( $Se_x$ )	No. Turb. Searched ( $n_x$ )	Proportion Turb. Searched ( $n_x / T$ )	Weighted Averages ( $Se_o$ )
<b>SPRING</b>				
KE	0.62	141	0.88	0.55
AC	0.86	19	0.12	0.10
<b>Total</b>				0.65
<b>SUMMER</b>				
KE	0.7	170	1	0.70
AC	-	0	0	-
<b>Total</b>				0.70
<b>FALL</b>				
KE	0.64	140	0.89	0.57
AC	0.91	17	0.11	0.10
<b>Total</b>				0.67

KE- Ken Edwards  
AC- Anna Corrigan

**Table 3.3: Scavenger Trials at the Adelaide Wind Energy Project, 2015**

	Placed	Visit 1	Visit 2	Visit 3	Visit 4	Sc as a proportion
<b>Spring</b>						
# of Carcasses	20	19	15	9	7	0.79
<b>Summer</b>						
# of Carcasses	20	18	15	9	7	0.79
<b>Fall</b>						
# of Carcasses	20	19	10	7	6	0.75



**ADELAIDE WIND POWER PROJECT: YEAR 1 POST-CONSTRUCTION WILDLIFE MONITORING REPORT (2015)**

Appendix E - Tables  
February 17, 2017

**Table 3.4: Average Monthly Percent Area Searched (Ps) at the Adelaide Wind Energy Project, 2015**

Month	Turbine	Vegetation/Crop	Ps (%)	Average Ps (%)
May	6	Soy	1	0.99
	7	Soy	1	
	11	Soy	1	
	12	Soy	1	
	14	Soy/Corn	1	
	17	Soy	0.94	
	19	Soy	1	
	20	Soy	1	
	22	Corn	1	
	27	Soy	1	
June	6	Soy	0.55	0.87
	7	Soy	0.95	
	11	Soy	1	
	12	Soy	0.96	
	14	Soy/Corn	1	
	17	Soy	0.48	
	19	Soy	1	
	20	Soy	1	
	22	Corn	0.79	
	27	Soy	1	
July	6	Soy	0.68	0.77
	7	Soy	0.88	
	11	Soy	0.68	
	12	Soy	0.5	
	14	Soy/Corn	0.86	
	17	Soy	0.59	
	19	Soy	0.92	
	20	Soy	1	
	22	Corn	0.65	
	27	Soy	0.99	

**ADELAIDE WIND POWER PROJECT: YEAR 1 POST-CONSTRUCTION WILDLIFE MONITORING REPORT (2015)**

Appendix E - Tables  
February 17, 2017

**Table 3.4: Average Monthly Percent Area Searched (Ps) at the Adelaide Wind Energy Project, 2015**

Month	Turbine	Vegetation/Crop	Ps (%)	Average Ps (%)
<b>August</b>	6	Soy	0.83	0.78
	7	Soy	0.87	
	11	Soy	0.3	
	12	Soy	0.89	
	14	Soy/Corn	0.5	
	17	Soy	1	
	19	Soy	0.89	
	20	Soy	0.96	
	22	Corn	0.7	
	27	Soy	0.95	
<b>September</b>	6	Soy	0.58	0.78
	7	Soy	0.91	
	11	Soy	0.31	
	12	Soy	0.89	
	14	Soy/Corn	0.5	
	17	Soy	1	
	19	Soy	1	
	20	Soy	1	
	22	Corn	0.67	
	27	Soy	0.95	
<b>October</b>	6	Soy	0.93	0.91
	7	Soy	0.97	
	11	Soy	0.86	
	12	Soy	0.99	
	14	Soy/Corn	0.66	
	17	Soy	1	
	19	Soy	1	
	20	Soy	1	
	22	Corn	0.74	
	27	Soy	1	
<b>Average % Searched</b>				<b>0.85</b>



## ADELAIDE WIND POWER PROJECT: YEAR 1 POST-CONSTRUCTION WILDLIFE MONITORING REPORT (2015)

Appendix E - Tables  
February 17, 2017

**Table 3.5: Uncorrected Monthly Raptor Fatalities, at the Adelaide Wind Energy Project, 2015**

Month	Species	Number of individuals	Turbine	Total per month
May	-	-	-	0
June	Red-tailed Hawk	2	6,11	4
	Turkey Vulture	2	27 <sup>1</sup>	
July	-	-	-	0
August	-	-	-	0
September	-	-	-	0
October	-	-	-	0
<b>Total</b>				<b>4</b>

<sup>1</sup> Two fatalities occurred at this turbine within the given time period.

**Table 3.6: Corrected Monthly Raptor Mortality Estimates at the Adelaide Wind Energy Project, 2015**

Month	c	SE	SC	PS	C	C per MW	C per Turbine
May	0	1.00	1.00	0.99	0.00	0.00	0.00
June	4	1.00	1.00	0.87	4.60	0.21	0.46
July	0	1.00	1.00	0.77	0.00	0.00	0.00
August	0	1.00	1.00	0.78	0.00	0.00	0.00
September	0	1.00	1.00	0.78	0.00	0.00	0.00
October	0	1.00	1.00	0.91	0.00	0.00	0.00
<b>TOTAL</b>	<b>4</b>				<b>4.60</b>	<b>0.21</b>	<b>0.46</b>

c Number of small bird carcasses located (uncorrected)

Se Searcher Efficiency Trial Results

Sc Scavenger Trial Results

Ps Percent Area Surveyed

C Corrected Mortality Estimate

Per Turbine C Divided by Total Number of Turbines

Per MW C Divided by Total Number of MegaWatts

**ADELAIDE WIND POWER PROJECT: YEAR 1 POST-CONSTRUCTION WILDLIFE MONITORING REPORT (2015)**

Appendix E - Tables  
February 17, 2017

**Table 3.7: Supplemental Monitoring and Incidental Fatalities at the Adelaide Wind Energy Project, 2015**

Date	Species	Turbine	Recovery/Survey Type
6/5/2015	Big Brown Bat	18	Incidentally by maintenance staff
6/19/2015	Yellow-billed Cuckoo	15	Monthly raptor monitoring program
6/21/2015	Osprey	9	Monthly raptor monitoring program
8/25/2015	Silver-haired Bat	5	Monthly raptor monitoring program
8/25/2015	Horned Lark	21	Monthly raptor monitoring program
8/25/2015	Hoary Bat	21	Monthly raptor monitoring program
8/25/2015	Little Brown Myotis	21	Monthly raptor monitoring program
9/21/2015	Silver-haired Bat	15	Monthly raptor monitoring program

**Table 3.8: Uncorrected Monthly Small Bird Fatalities at the Adelaide Wind Energy Project, 2015**

Month	Species	Number of individuals	Turbine	Total per month
May	None	0	n/a	0
June	None	0	n/a	0
July	Cliff Swallow	1	17	2
	Mourning Dove	1	17	
August	Tree Swallow	2	6, 19	2
September	Tree Swallow	2	11, 20	2
October	Golden-crowned Kinglet	2	14, 20	4
	Horned Lark	1	22	
	Ovenbird	1	20	

# ADELAIDE WIND POWER PROJECT: YEAR 1 POST-CONSTRUCTION WILDLIFE MONITORING REPORT (2015)

Appendix E - Tables  
February 17, 2017

**Table 3.9: Small Bird Fatalities per Turbine at the Adelaide Wind Energy Project, 2015**

Turbine	May		June		July		August		September		October		Total	
	c	C	c	C	c	C	c	C	c	C	c	C	c	C
6	0.00	0.00	0.00	0.00	0.00	0.00	1.00	2.32	0.00	0.00	0.00	0.00	1.00	2.32
7	0.00	0.00	0.00	0.00	0.00	0.00	0.00	0.00	0.00	0.00	0.00	0.00	0.00	0.00
11	0.00	0.00	0.00	0.00	0.00	0.00	0.00	0.00	1.00	2.55	0.00	0.00	1.00	2.55
12	0.00	0.00	0.00	0.00	0.00	0.00	0.00	0.00	0.00	0.00	0.00	0.00	0.00	0.00
14	0.00	0.00	0.00	0.00	0.00	0.00	0.00	0.00	0.00	0.00	1.00	2.19	1.00	2.19
17	0.00	0.00	0.00	0.00	2.00	4.70	0.00	0.00	0.00	0.00	0.00	0.00	2.00	4.70
19	0.00	0.00	0.00	0.00	0.00	0.00	1.00	2.32	0.00	0.00	0.00	0.00	1.00	2.32
20	0.00	0.00	0.00	0.00	0.00	0.00	0.00	0.00	1.00	2.55	2.00	4.37	3.00	6.93
22	0.00	0.00	0.00	0.00	0.00	0.00	0.00	0.00	0.00	0.00	1.00	2.19	1.00	2.19
27	0.00	0.00	0.00	0.00	0.00	0.00	0.00	0.00	0.00	0.00	0.00	0.00	0.00	0.00

c Number of small bird carcasses located (uncorrected)

C Corrected Mortality Estimate

**Table 3.10: Corrected Monthly Small Bird Mortality Estimates at the Adelaide Wind Energy Project, 2015**

Month	c	SE	SC	PS	C	C per MW	C per Turbine
May	0	0.65	0.79	0.99	0.00	0.00	0.00
June	0	0.65	0.79	0.87	0.00	0.00	0.00
July	2	0.70	0.79	0.77	4.70	0.21	0.47
August	2	0.70	0.79	0.78	4.64	0.21	0.46
September	2	0.67	0.75	0.78	5.10	0.23	0.51
October	4	0.67	0.75	0.91	8.75	0.40	0.88
<b>TOTAL</b>	<b>10</b>				<b>23.19</b>	<b>1.05</b>	<b>2.32</b>

c Number of small bird carcasses located (uncorrected)

Se Searcher Efficiency Trial Results

Sc Scavenger Trial Results

Ps Percent Area Surveyed

C Corrected Mortality Estimate

Per Turbine C Divided by Total Number of Turbines

Per MW C Divided by Total Number of MegaWatts



**ADELAIDE WIND POWER PROJECT: YEAR 1 POST-CONSTRUCTION WILDLIFE MONITORING REPORT (2015)**

Appendix E - Tables  
February 17, 2017

**Table 3.11: Uncorrected Monthly Bat Fatalities at the Adelaide Wind Energy Project, 2015**

Month	Species	Number of Individuals	Turbine
May	None	0	n/a
June	Silver-haired Bat	1	22
July	Big Brown Bat	4	7, 11, 12, 20
	Hoary Bat	4	6, 19, 22, 27
August	Big Brown Bat	5	6, 14, 19, 20, 22
	Red Bat	2	17 <sup>1</sup>
	Hoary Bat	8	6 <sup>1</sup> , 11 <sup>1</sup> , 12, 14, 17, 20
September	Big Brown Bat	1	6
	Hoary Bat	3	12, 17 <sup>1</sup>
	Silver-haired Bat	6	6 <sup>1</sup> , 7, 17, 19, 20
October	Red Bat	1	27
	Hoary Bat	1	27
<b>TOTAL</b>		<b>36</b>	

<sup>1</sup> Two fatalities occurred at this turbine within the given time period.

**Table 3.12: Uncorrected Bat Fatalities by Turbine at the Adelaide Wind Energy Project, 2015**

Turbine	Number of Individuals
6	7
7	2
11	3
12	3
14	2
17	6
19	3
20	4
22	3
27	3



**ADELAIDE WIND POWER PROJECT: YEAR 1 POST-CONSTRUCTION WILDLIFE MONITORING REPORT (2015)**

Appendix E - Tables  
February 17, 2017

**Table 3.13: Corrected Bat Mortality Estimates at the Adelaide Wind Energy Project, 2015**

Month	c	SE	SC	PS	C	C per MW	C per Turbine
May	0	0.65	0.79	0.99	0	0	0
June	1	0.65	0.79	0.87	2.24	0.1	0.22
July	8	0.70	0.79	0.77	18.79	0.85	1.88
August	15	0.70	0.79	0.78	34.78	1.57	3.48
September	10	0.67	0.75	0.78	25.51	1.15	2.55
October	2	0.67	0.75	0.91	4.37	0.2	0.44
<b>TOTAL</b>	<b>36</b>				<b>85.69</b>	<b>3.87</b>	<b>8.57</b>

- c                    Number of bat carcasses located (uncorrected)
- Se                   Searcher Efficiency Trial Results
- Sc                   Scavenger Impact Trial Results
- Ps                   Percent Area Surveyed
- C                    Corrected Mortality Estimate
- Per Turbine       C Divided by Total Number of Turbines
- Per MW            C Divided by Total Number of MegaWatts

**ADELAIDE WIND POWER PROJECT: YEAR 1 POST-CONSTRUCTION WILDLIFE MONITORING REPORT (2015)**

Appendix E - Tables  
February 17, 2017

**Table 3.14: Amphibian Survey: Maximum Call-count Code Results**

Feature Number	Survey Station	Year	Highest Call Code <sup>1</sup> Recorded in Year							Total Number of Species Recorded <sup>2</sup>
			Spring Peeper	Western Chorus Frog	American Toad	Northern Leopard Frog	Wood Frog	Gray Treefrog	Green Frog	
<b>WITHIN 120 M OF THE PROJECT LOCATION</b>										
6	F6-1	2013	2	-	1	-	-	3	-	<b>3</b>
		2015	3	-	-	1	-	2	1	<b>4</b>
	F6-2	2013	3	1	1	-	1	1	-	<b>5</b>
		2015	>100 m	-	-	-	-	>100 m	>100 m	<b>3</b>
	F6-3	2013	3	-	-	-	-	3	1	<b>3</b>
		2015	3	-	-	-	-	2	1	<b>3</b>
16	F16	2013	2	1	3	-	1	2	-	<b>5</b>
		2015	3	1	>100 m	-	-	1	-	<b>4</b>
20	F20	2013	2	1	>100 m	-	-	2	1	<b>5</b>
		2015	2	-	1	-	-	1	-	<b>3</b>

1- Call code categories: (1) calls not simultaneous – number of individuals can be accurately counted; (2) some calls simultaneous – number of individuals can be reliably estimated; and (3) full chorus – calls continuous and overlapping. The maximum call code recorded over the three surveys was used.

2- Green text indicates a gain and red text indicates a loss, as compared with the baseline results in 2013.

# APPENDIX F: RAW MORTALITY DATA

**Table F1: Weekly Mortality Monitoring Survey Record**

Project Name	Turbine Number	Treatment Group	Day	Month	Year	Start Time	End Time	Duration Min	Number Of Searchers	Searchers' Names	Days Since Last Search	Actual Area Searched M2	Dog Used	Search Area Shape	Search Area Dimension	Transect Separation M	Temp Celsius	Wind Speed	Wind Direction	Precipitation	Cloud Cover Percentage	Significant Weather	Comments
Adelaide Wind Farm	7	Sub set	4	5	2015	8:40	9:10	40	1	Ken Edwards	First search of the year	7854	No	Circular	50m radius, 100m by 100m	5-6	13-16	23	SW	None	90	None	
Adelaide Wind Farm	11	Sub set	4	5	2015	9:20	10:05	45	1	Ken Edwards	First search of the year	7854	No	Circular	50m radius, 100m by 100m	5-6	13-16	23	SW	None	90	None	
Adelaide Wind Farm	12	Sub set	4	5	2015	10:15	11:00	45	1	Ken Edwards	First search of the year	7854	No	Circular	50m radius, 100m by 100m	5-6	13-16	23	SW	None	90	None	
Adelaide Wind Farm	17	Sub set	4	5	2015	11:15	11:50	35	1	Ken Edwards	First search of the year	7854	No	Circular	50m radius, 100m by 100m	5-6	13-16	23	SW	None	90	None	
Adelaide Wind Farm	19	Sub set	4	5	2015	12:00	12:30	30	1	Ken Edwards	First search of the year	7854	No	Circular	50m radius, 100m by 100m	5-6	13-16	23	SW	None	90	None	
Adelaide Wind Farm	20	Sub set	4	5	2015	12:55	13:30	35	1	Ken Edwards	First search of the year	7854	No	Circular	50m radius, 100m by 100m	5-6	13-16	23	SW	None	90	None	
Adelaide Wind Farm	22	Sub set	4	5	2015	13:40	14:20	40	1	Ken Edwards	First search of the year	7854	No	Circular	50m radius, 100m by 100m	5-6	13-16	23	SW	None	90	None	
Adelaide Wind Farm	27	Sub set	4	5	2015	14:30	15:15	45	1	Ken Edwards	First search of the year	7854	No	Circular	50m radius, 100m by 100m	5-6	13-16	23	SW	None	90	None	
Adelaide Wind Farm	14	Sub set	4	5	2015	15:30	16:00	30	1	Ken Edwards	First search of the year	7854	No	Circular	50m radius, 100m by 100m	5-6	13-16	23	SW	None	90	None	
Adelaide Wind Farm	6	Sub set	4	5	2015	16:10	16:45	35	1	Ken Edwards	First search of the year	7854	No	Circular	50m radius, 100m by 100m	5-6	13-16	23	SW	None	90	None	
Adelaide Wind Farm	7	Sub set	7	5	2015	8:30	9:10	40	1	Ken Edwards	3	7854	No	Circular	50m radius, 100m by 100m	5-6	16-26	10	SE	None	20	None	
Adelaide Wind Farm	12	Sub set	7	5	2015	9:30	10:10	40	1	Ken Edwards	3	7854	No	Circular	50m radius, 100m by 100m	5-6	16-26	10	SE	None	20	None	

**Table F1: Weekly Mortality Monitoring Survey Record**

Project Name	Turbine Number	Treatment Group	Day	Month	Year	Start Time	End Time	Duration Min	Number Of Searchers	Searchers' Names	Days Since Last Search	Actual Area Searched M2	Dog Used	Search Area Shape	Search Area Dimension	Transect Separation M	Temp Celsius	Wind Speed	Wind Direction	Precipitation	Cloud Cover Percentage	Significant Weather	Comments
Adelaide Wind Farm	14	Sub set	7	5	2015	10:20	10:55	35	1	Ken Edwards	3	7854	No	Circular	50m radius, 100m by 100m	5-6	16-26	10	SE	None	20	None	
Adelaide Wind Farm	17	Sub set	7	5	2015	11:05	11:35	30	1	Ken Edwards	3	7854	No	Circular	50m radius, 100m by 100m	5-6	16-26	10	SE	None	20	None	
Adelaide Wind Farm	19	Sub set	7	5	2015	11:45	12:15	30	1	Ken Edwards	3	7854	No	Circular	50m radius, 100m by 100m	5-6	16-26	10	SE	None	20	None	
Adelaide Wind Farm	20	Sub set	7	5	2015	12:25	12:55	30	1	Ken Edwards	3	7854	No	Circular	50m radius, 100m by 100m	5-6	16-26	10	SE	None	20	None	
Adelaide Wind Farm	22	Sub set	7	5	2015	13:05	13:45	40	1	Ken Edwards	3	7854	No	Circular	50m radius, 100m by 100m	5-6	16-26	10	SE	None	20	None	
Adelaide Wind Farm	27	Sub set	7	5	2015	14:00	14:30	30	1	Ken Edwards	3	7854	No	Circular	50m radius, 100m by 100m	5-6	16-26	10	SE	None	20	None	
Adelaide Wind Farm	11	Sub set	7	5	2015	14:40	15:15	35	1	Ken Edwards	3	7854	No	Circular	50m radius, 100m by 100m	5-6	16-26	10	SE	None	20	None	
Adelaide Wind Farm	6	Sub set	7	5	2015	15:25	15:55	30	1	Ken Edwards	3	7854	No	Circular	50m radius, 100m by 100m	5-6	16-26	10	SE	None	20	None	
Adelaide Wind Farm	6	Sub set	11	5	2015	8:40	9:15	35	1	Ken Edwards	4	7854	No	Circular	50m radius, 100m by 100m	5-6	16-28	18	S	None	50-100	Light Rain	
Adelaide Wind Farm	7	Sub set	11	5	2015	9:25	10:10	45	1	Ken Edwards	4	7854	No	Circular	50m radius, 100m by 100m	5-6	16-28	18	S	None	50-100	Light Rain	
Adelaide Wind Farm	11	Sub set	11	5	2015	10:20	11:00	40	1	Ken Edwards	4	7854	No	Circular	50m radius, 100m by 100m	5-6	16-28	18	S	None	50-100	Light Rain	
Adelaide Wind Farm	12	Sub set	11	5	2015	11:10	11:45	35	1	Ken Edwards	4	7854	No	Circular	50m radius, 100m by 100m	5-6	16-28	18	S	None	50-100	Light Rain	

**Table F1: Weekly Mortality Monitoring Survey Record**

Project Name	Turbine Number	Treatment Group	Day	Month	Year	Start Time	End Time	Duration Min	Number Of Searchers	Searchers' Names	Days Since Last Search	Actual Area Searched M2	Dog Used	Search Area Shape	Search Area Dimension	Transect Separation M	Temp Celsius	Wind Speed	Wind Direction	Precipitation	Cloud Cover Percentage	Significant Weather	Comments
Adelaide Wind Farm	14	Sub set	11	5	2015	11:50	12:20	30	1	Ken Edwards	4	7854	No	Circular	50m radius, 100m by 100m	5-6	16-28	18	S	None	50-100	Light Rain	
Adelaide Wind Farm	17	Sub set	11	5	2015	12:30	13:10	40	1	Ken Edwards	4	7854	No	Circular	50m radius, 100m by 100m	5-6	16-28	18	S	None	50-100	Light Rain	
Adelaide Wind Farm	19	Sub set	11	5	2015	13:20	14:00	40	1	Ken Edwards	4	7854	No	Circular	50m radius, 100m by 100m	5-6	16-28	18	S	None	50-100	Light Rain	
Adelaide Wind Farm	20	Sub set	11	5	2015	14:15	14:50	35	1	Ken Edwards	4	7854	No	Circular	50m radius, 100m by 100m	5-6	16-28	18	S	None	50-100	Light Rain	
Adelaide Wind Farm	22	Sub set	11	5	2015	14:55	15:25	30	1	Ken Edwards	4	7854	No	Circular	50m radius, 100m by 100m	5-6	16-28	18	S	None	50-100	Light Rain	
Adelaide Wind Farm	27	Sub set	11	5	2015	15:35	16:05	30	1	Ken Edwards	4	7854	No	Circular	50m radius, 100m by 100m	5-6	16-28	18	S	None	50-100	Light Rain	
Adelaide Wind Farm	6	Sub set	14	5	2015	8:40	9:20	40	1	Ken Edwards	3	7854	No	Circular	50m radius, 100m by 100m	5-6	8 to 20	6	E	None	0	None	
Adelaide Wind Farm	7	Sub set	14	5	2015	9:30	10:00	30	1	Ken Edwards	3	7854	No	Circular	50m radius, 100m by 100m	5-6	8 to 20	6	E	None	0	None	
Adelaide Wind Farm	12	Sub set	14	5	2015	10:15	10:50	35	1	Ken Edwards	3	7854	No	Circular	50m radius, 100m by 100m	5-6	8 to 20	6	E	None	0	None	
Adelaide Wind Farm	14	Sub set	14	5	2015	11:00	11:40	40	1	Ken Edwards	3	7854	No	Circular	50m radius, 100m by 100m	5-6	8 to 20	6	E	None	0	None	
Adelaide Wind Farm	17	Sub set	14	5	2015	11:50	12:20	30	1	Ken Edwards	3	7854	No	Circular	50m radius, 100m by 100m	5-6	8 to 20	6	E	None	0	None	
Adelaide Wind Farm	20	Sub set	14	5	2015	12:50	13:25	35	1	Ken Edwards	3	7854	No	Circular	50m radius, 100m by 100m	5-6	8 to 20	6	E	None	0	None	

**Table F1: Weekly Mortality Monitoring Survey Record**

Project Name	Turbine Number	Treatment Group	Day	Month	Year	Start Time	End Time	Duration Min	Number Of Searchers	Searchers' Names	Days Since Last Search	Actual Area Searched M2	Dog Used	Search Area Shape	Search Area Dimension	Transect Separation M	Temp Celsius	Wind Speed	Wind Direction	Precipitation	Cloud Cover Percentage	Significant Weather	Comments
Adelaide Wind Farm	22	Sub set	14	5	2015	13:35	14:10	35	1	Ken Edwards	3	7854	No	Circular	50m radius, 100m by 100m	5-6	8 to 20	6	E	None	0	None	
Adelaide Wind Farm	27	Sub set	14	5	2015	14:20	15:00	40	1	Ken Edwards	3	7854	No	Circular	50m radius, 100m by 100m	5-6	8 to 20	6	E	None	0	None	
Adelaide Wind Farm	6	Sub set	19	5	2015	8:40	9:20	40	1	Ken Edwards	5	7854	No	Circular	50m radius, 100m by 100m	5-6	14	19	W N W	None	40	None	
Adelaide Wind Farm	7	Sub set	19	5	2015	9:30	10:05	35	1	Ken Edwards	5	7854	No	Circular	50m radius, 100m by 100m	5-6	14	19	W N W	None	40	None	
Adelaide Wind Farm	11	Sub set	19	5	2015	10:15	10:45	30	1	Ken Edwards	8	7854	No	Circular	50m radius, 100m by 100m	5-6	14	19	W N W	None	40	None	
Adelaide Wind Farm	12	Sub set	19	5	2015	11:00	11:35	35	1	Ken Edwards	5	7854	No	Circular	50m radius, 100m by 100m	5-6	14	19	W N W	None	40	None	
Adelaide Wind Farm	14	Sub set	19	5	2015	11:45	12:20	35	1	Ken Edwards	5	7854	No	Circular	50m radius, 100m by 100m	5-6	14	19	W N W	None	40	None	
Adelaide Wind Farm	17	Sub set	19	5	2015	12:35	13:05	30	1	Ken Edwards	5	7854	No	Circular	50m radius, 100m by 100m	5-6	14	19	W N W	None	40	None	
Adelaide Wind Farm	20	Sub set	19	5	2015	13:15	13:55	40	1	Ken Edwards	5	7854	No	Circular	50m radius, 100m by 100m	5-6	14	19	W N W	None	40	None	
Adelaide Wind Farm	22	Sub set	19	5	2015	14:05	14:35	30	1	Ken Edwards	5	7854	No	Circular	50m radius, 100m by 100m	5-6	14	19	W N W	None	40	None	
Adelaide Wind Farm	27	Sub set	19	5	2015	14:50	15:25	35	1	Ken Edwards	5	7854	No	Circular	50m radius, 100m by 100m	5-6	14	19	W N W	None	40	None	
Adelaide Wind Farm	19	Sub set	19	5	2015	15:35	16:10	35	1	Ken Edwards	8	7854	No	Circular	50m radius, 100m by 100m	5-6	14	19	W N W	None	40	None	

**Table F1: Weekly Mortality Monitoring Survey Record**

Project Name	Turbine Number	Treatment Group	Day	Month	Year	Start Time	End Time	Duration Min	Number Of Searchers	Searchers' Names	Days Since Last Search	Actual Area Searched M2	Dog Used	Search Area Shape	Search Area Dimension	Transect Separation M	Temp Celsius	Wind Speed	Wind Direction	Precipitation	Cloud Cover Percentage	Significant Weather	Comments
Adelaide Wind Farm	6	Sub set	22	5	2015	8:45	9:20	35	1	Ken Edwards	3	7854	No	Circular	50m radius, 100m by 100m	5-6	6 to 10	16	NN W	None	0	None	
Adelaide Wind Farm	7	Sub set	22	5	2015	9:30	10:05	35	1	Ken Edwards	3	7854	No	Circular	50m radius, 100m by 100m	5-6	6 to 10	16	NN W	None	0	None	
Adelaide Wind Farm	11	Sub set	22	5	2015	10:15	10:45	30	1	Ken Edwards	3	7854	No	Circular	50m radius, 100m by 100m	5-6	6 to 10	16	NN W	None	0	None	
Adelaide Wind Farm	12	Sub set	22	5	2015	10:55	11:30	35	1	Ken Edwards	3	7854	No	Circular	50m radius, 100m by 100m	5-6	6 to 10	16	NN W	None	0	None	
Adelaide Wind Farm	14	Sub set	22	5	2015	11:50	12:25	35	1	Ken Edwards	3	7854	No	Circular	50m radius, 100m by 100m	5-6	6 to 10	16	NN W	None	0	None	
Adelaide Wind Farm	17	Sub set	22	5	2015	12:35	13:10	35	1	Ken Edwards	3	7854	No	Circular	50m radius, 100m by 100m	5-6	6 to 10	16	NN W	None	0	None	
Adelaide Wind Farm	20	Sub set	22	5	2015	13:20	13:55	35	1	Ken Edwards	3	7854	No	Circular	50m radius, 100m by 100m	5-6	6 to 10	16	NN W	None	0	None	
Adelaide Wind Farm	22	Sub set	22	5	2015	14:05	14:45	40	1	Ken Edwards	3	7854	No	Circular	50m radius, 100m by 100m	5-6	6 to 10	16	NN W	None	0	None	
Adelaide Wind Farm	27	Sub set	22	5	2015	15:00	15:40	40	1	Ken Edwards	3	7854	No	Circular	50m radius, 100m by 100m	5-6	6 to 10	16	NN W	None	0	None	
Adelaide Wind Farm	19	Sub set	22	5	2015	15:55	16:25	30	1	Ken Edwards	3	7854	No	Circular	50m radius, 100m by 100m	5-6	6 to 10	16	NN W	None	0	None	
Adelaide Wind Farm	6	Sub set	25	5	2015	8:40	9:15	35	1	Ken Edwards	3	7854	No	Circular	50m radius, 100m by 100m	5-6	18	18	SE	None	100	None	
Adelaide Wind Farm	7	Sub set	25	5	2015	9:25	9:55	30	1	Ken Edwards	3	7854	No	Circular	50m radius, 100m by 100m	5-6	18	18	SE	None	100	None	



**Table F1: Weekly Mortality Monitoring Survey Record**

Project Name	Turbine Number	Treatment Group	Day	Month	Year	Start Time	End Time	Duration Min	Number Of Searchers	Searchers' Names	Days Since Last Search	Actual Area Searched M2	Dog Used	Search Area Shape	Search Area Dimension	Transect Separation M	Temp Celsius	Wind Speed	Wind Direction	Precipitation	Cloud Cover Percentage	Significant Weather	Comments
Adelaide Wind Farm	11	Sub set	25	5	2015	10:05	10:40	35	1	Ken Edwards	3	7854	No	Circular	50m radius, 100m by 100m	5-6	18	18	SE	None	100	None	
Adelaide Wind Farm	12	Sub set	25	5	2015	11:00	11:40	40	1	Ken Edwards	3	7854	No	Circular	50m radius, 100m by 100m	5-6	18	18	SE	None	100	None	
Adelaide Wind Farm	14	Sub set	25	5	2015	11:50	12:20	30	1	Ken Edwards	3	7854	No	Circular	50m radius, 100m by 100m	5-6	18	18	SE	None	100	None	
Adelaide Wind Farm	17	Sub set	25	5	2015	12:30	13:05	35	1	Ken Edwards	3	7854	No	Circular	50m radius, 100m by 100m	5-6	18	18	SE	None	100	None	
Adelaide Wind Farm	22	Sub set	25	5	2015	13:20	14:00	40	1	Ken Edwards	3	7854	No	Circular	50m radius, 100m by 100m	5-6	18	18	SE	None	100	None	
Adelaide Wind Farm	27	Sub set	25	5	2015	14:15	14:55	40	1	Ken Edwards	3	7854	No	Circular	50m radius, 100m by 100m	5-6	18	18	SE	None	100	None	
Adelaide Wind Farm	20	Sub set	25	5	2015	15:10	15:40	30	1	Ken Edwards	3	7854	No	Circular	50m radius, 100m by 100m	5-6	18	18	SE	None	100	None	
Adelaide Wind Farm	19	Sub set	25	5	2015	15:45	16:20	35	1	Ken Edwards	3	7854	No	Circular	50m radius, 100m by 100m	5-6	18	18	SE	None	100	None	
Adelaide Wind Farm	6	Sub set	28	5	2015	8:35	9:15	40	1	Ken Edwards	3	7854	No	Circular	50m radius, 100m by 100m	5-6	16-22	10	NN W	None	0	Rain	
Adelaide Wind Farm	7	Sub set	28	5	2015	9:25	10:10	45	1	Ken Edwards	3	7854	No	Circular	50m radius, 100m by 100m	5-6	16-22	10	NN W	None	0	Rain	
Adelaide Wind Farm	11	Sub set	28	5	2015	10:20	11:05	45	1	Ken Edwards	3	7854	No	Circular	50m radius, 100m by 100m	5-6	16-22	10	NN W	None	0	Rain	
Adelaide Wind Farm	12	Sub set	28	5	2015	11:15	12:00	45	1	Ken Edwards	3	7854	No	Circular	50m radius, 100m by 100m	5-6	16-22	10	NN W	None	0	Rain	

**Table F1: Weekly Mortality Monitoring Survey Record**

Project Name	Turbine Number	Treatment Group	Day	Month	Year	Start Time	End Time	Duration Min	Number Of Searchers	Searchers' Names	Days Since Last Search	Actual Area Searched M2	Dog Used	Search Area Shape	Search Area Dimension	Transect Separation M	Temp Celsius	Wind Speed	Wind Direction	Precipitation	Cloud Cover Percentage	Significant Weather	Comments
Adelaide Wind Farm	14	Sub set	28	5	2015	12:10	12:50	40	1	Ken Edwards	3	7854	No	Circular	50m radius, 100m by 100m	5-6	16-22	10	NN W	None	0	Rain	
Adelaide Wind Farm	17	Sub set	28	5	2015	13:15	13:45	30	1	Ken Edwards	3	3992	No	Circular	50m radius, 100m by 100m	5-6	16-22	10	NN W	None	0	Rain	
Adelaide Wind Farm	19	Sub set	28	5	2015	13:55	14:35	40	1	Ken Edwards	3	7854	No	Circular	50m radius, 100m by 100m	5-6	16-22	10	NN W	None	0	Rain	
Adelaide Wind Farm	20	Sub set	28	5	2015	14:45	15:25	40	1	Ken Edwards	3	7854	No	Circular	50m radius, 100m by 100m	5-6	16-22	10	NN W	None	0	Rain	
Adelaide Wind Farm	22	Sub set	28	5	2015	15:35	16:20	45	1	Ken Edwards	3	7854	No	Circular	50m radius, 100m by 100m	5-6	16-22	10	NN W	None	0	Rain	
Adelaide Wind Farm	27	Sub set	28	5	2015	16:25	17:10	45	1	Ken Edwards	3	7854	No	Circular	50m radius, 100m by 100m	5-6	16-22	10	NN W	None	0	Rain	
Adelaide Wind Farm	6	Sub set	1	6	2015	8:40	9:25	45	1	Ken Edwards	4	7854	No	Circular	50m radius, 100m by 100m	5-6	15-20	18	NE	None	30	Rain	
Adelaide Wind Farm	11	Sub set	1	6	2015	9:35	10:15	40	1	Ken Edwards	4	7854	No	Circular	50m radius, 100m by 100m	5-6	15-20	18	NE	None	30	Rain	
Adelaide Wind Farm	14	Sub set	1	6	2015	10:25	11:10	45	1	Ken Edwards	4	7854	No	Circular	50m radius, 100m by 100m	5-6	15-20	18	NE	None	30	Rain	
Adelaide Wind Farm	17	Sub set	1	6	2015	11:20	11:55	35	1	Ken Edwards	4	3992	No	Circular	50m radius, 100m by 100m	5-6	15-20	18	NE	None	30	Rain	
Adelaide Wind Farm	19	Sub set	1	6	2015	12:05	12:45	40	1	Ken Edwards	4	7854	No	Circular	50m radius, 100m by 100m	5-6	15-20	18	NE	None	30	Rain	
Adelaide Wind Farm	20	Sub set	1	6	2015	12:55	13:35	40	1	Ken Edwards	4	7854	No	Circular	50m radius, 100m by 100m	5-6	15-20	18	NE	None	30	Rain	

**Table F1: Weekly Mortality Monitoring Survey Record**

Project Name	Turbine Number	Treatment Group	Day	Month	Year	Start Time	End Time	Duration Min	Number Of Searchers	Searchers' Names	Days Since Last Search	Actual Area Searched M2	Dog Used	Search Area Shape	Search Area Dimension	Transect Separation M	Temp Celsius	Wind Speed	Wind Direction	Precipitation	Cloud Cover Percentage	Significant Weather	Comments
Adelaide Wind Farm	22	Sub set	1	6	2015	13:45	14:25	40	1	Ken Edwards	4	7854	No	Circular	50m radius, 100m by 100m	5-6	15-20	18	NE	None	30	Rain	
Adelaide Wind Farm	27	Sub set	1	6	2015	14:35	15:25	50	1	Ken Edwards	4	7854	No	Circular	50m radius, 100m by 100m	5-6	15-20	18	NE	None	30	Rain	
Adelaide Wind Farm	12	Sub set	1	6	2015	15:45	16:20	35	1	Ken Edwards	4	7854	No	Circular	50m radius, 100m by 100m	5-6	15-20	18	NE	None	30	Rain	
Adelaide Wind Farm	7	Sub set	1	6	2015	16:40	17:25	45	1	Ken Edwards	4	7854	No	Circular	50m radius, 100m by 100m	5-6	15-20	18	NE	None	30	Rain	
Adelaide Wind Farm	6	Sub set	4	6	2015	9:00	9:45	45	1	Ken Edwards	3	4347	No	Circular	50m radius, 100m by 100m	5-6	16-22	13	SSE	None	40	None	
Adelaide Wind Farm	7	Sub set	4	6	2015	10:00	10:40	40	1	Ken Edwards	3	6939	No	Circular	50m radius, 100m by 100m	5-6	16-22	13	SSE	None	40	None	
Adelaide Wind Farm	11	Sub set	4	6	2015	12:10	12:55	35	1	Ken Edwards	3	7854	No	Circular	50m radius, 100m by 100m	5-6	16-22	13	SSE	None	40	None	
Adelaide Wind Farm	12	Sub set	4	6	2015	13:15	13:55	40	1	Ken Edwards	3	7854	No	Circular	50m radius, 100m by 100m	5-6	16-22	13	SSE	None	40	None	
Adelaide Wind Farm	14	Sub set	4	6	2015	14:05	14:45	40	1	Ken Edwards	3	7854	No	Circular	50m radius, 100m by 100m	5-6	16-22	13	SSE	None	40	None	
Adelaide Wind Farm	17	Sub set	4	6	2015	15:00	15:35	35	1	Ken Edwards	3	3992	No	Circular	50m radius, 100m by 100m	5-6	16-22	13	SSE	None	40	None	
Adelaide Wind Farm	19	Sub set	4	6	2015	15:55	16:45	50	1	Ken Edwards	3	7854	No	Circular	50m radius, 100m by 100m	5-6	16-22	13	SSE	None	40	None	
Adelaide Wind Farm	20	Sub set	4	6	2015	16:55	17:30	35	1	Ken Edwards	3	7854	No	Circular	50m radius, 100m by 100m	5-6	16-22	13	SSE	None	40	None	

**Table F1: Weekly Mortality Monitoring Survey Record**

Project Name	Turbine Number	Treatment Group	Day	Month	Year	Start Time	End Time	Duration Min	Number Of Searchers	Searchers' Names	Days Since Last Search	Actual Area Searched M2	Dog Used	Search Area Shape	Search Area Dimension	Transect Separation M	Temp Celsius	Wind Speed	Wind Direction	Precipitation	Cloud Cover Percentage	Significant Weather	Comments
Adelaide Wind Farm	22	Sub set	4	6	2015	17:45	18:30	45	1	Ken Edwards	3	7695	No	Circular	50m radius, 100m by 100m	5-6	16-22	13	SSE	None	40	None	
Adelaide Wind Farm	27	Sub set	4	6	2015	18:40	19:25	45	1	Ken Edwards	3	7854	No	Circular	50m radius, 100m by 100m	5-6	16-22	13	SSE	None	40	None	
Adelaide Wind Farm	6	Sub set	8	6	2015	8:45	9:25	40	1	Ken Edwards	4	4347	No	Circular	50m radius, 100m by 100m	5-6	19-23	16	WS W	Rain	100	Rain	
Adelaide Wind Farm	7	Sub set	8	6	2015	9:35	10:20	45	1	Ken Edwards	4	7854	No	Circular	50m radius, 100m by 100m	5-6	19-23	16	WS W	Rain	100	Rain	
Adelaide Wind Farm	11	Sub set	8	6	2015	10:30	11:20	50	1	Ken Edwards	4	7854	No	Circular	50m radius, 100m by 100m	5-6	19-23	16	WS W	Rain	100	Rain	
Adelaide Wind Farm	12	Sub set	8	6	2015	11:30	12:20	50	1	Ken Edwards	4	7854	No	Circular	50m radius, 100m by 100m	5-6	19-23	16	WS W	Rain	100	Rain	
Adelaide Wind Farm	14	Sub set	8	6	2015	12:30	13:30	60	1	Ken Edwards	4	7854	No	Circular	50m radius, 100m by 100m	5-6	19-23	16	WS W	Rain	100	Rain	
Adelaide Wind Farm	17	Sub set	8	6	2015	13:40	14:25	45	1	Ken Edwards	4	3992	No	Circular	50m radius, 100m by 100m	5-6	19-23	16	WS W	Rain	100	Rain	
Adelaide Wind Farm	19	Sub set	8	6	2015	14:30	15:20	50	1	Ken Edwards	4	7854	No	Circular	50m radius, 100m by 100m	5-6	19-23	16	WS W	Rain	100	Rain	
Adelaide Wind Farm	20	Sub set	8	6	2015	15:30	16:25	55	1	Ken Edwards	4	7854	No	Circular	50m radius, 100m by 100m	5-6	19-23	16	WS W	Rain	100	Rain	
Adelaide Wind Farm	22	Sub set	8	6	2015	16:35	17:30	55	1	Ken Edwards	4	7695	No	Circular	50m radius, 100m by 100m	5-6	19-23	16	WS W	Rain	100	Rain	
Adelaide Wind Farm	7	Sub set	11	6	2015	8:03	8:34	31	1	Anna Corrigan	3	6939	No	Circular	50m radius, 100m by 100m	5-6	14-23	5 to 13	N W	None	40-100	Thundersh owers	

**Table F1: Weekly Mortality Monitoring Survey Record**

Project Name	Turbine Number	Treatment Group	Day	Month	Year	Start Time	End Time	Duration Min	Number Of Searchers	Searchers' Names	Days Since Last Search	Actual Area Searched M2	Dog Used	Search Area Shape	Search Area Dimension	Transect Separation M	Temp Celsius	Wind Speed	Wind Direction	Precipitation	Cloud Cover Percentage	Significant Weather	Comments
Adelaide Wind Farm	6	Sub set	11	6	2015	8:44	9:14	30	1	Anna Corrigan	3	4347	No	Circular	50m radius, 100m by 100m	5-6	14-23	5 to 13	N W	None	40-100	Thundersh owers	
Adelaide Wind Farm	11	Sub set	11	6	2015	9:23	9:55	32	1	Anna Corrigan	3	7854	No	Circular	50m radius, 100m by 100m	5-6	14-23	5 to 13	N W	None	40-100	Thundersh owers	
Adelaide Wind Farm	12	Sub set	11	6	2015	10:20	10:51	31	1	Anna Corrigan	3	7854	No	Circular	50m radius, 100m by 100m	5-6	14-23	5 to 13	N W	None	40-100	Thundersh owers	
Adelaide Wind Farm	14	Sub set	11	6	2015	10:58	11:28	30	1	Anna Corrigan	3	7854	No	Circular	50m radius, 100m by 100m	5-6	14-23	5 to 13	N W	None	40-100	Thundersh owers	
Adelaide Wind Farm	17	Sub set	11	6	2015	11:35	12:05	30	1	Anna Corrigan	3	3992	No	Circular	50m radius, 100m by 100m	5-6	14-23	5 to 13	N W	None	40-100	Thundersh owers	
Adelaide Wind Farm	19	Sub set	11	6	2015	12:11	12:43	32	1	Anna Corrigan	3	7854	No	Circular	50m radius, 100m by 100m	5-6	14-23	5 to 13	N W	None	40-100	Thundersh owers	
Adelaide Wind Farm	20	Sub set	11	6	2015	12:54	13:24	30	1	Anna Corrigan	3	7854	No	Circular	50m radius, 100m by 100m	5-6	14-23	5 to 13	N W	None	40-100	Thundersh owers	
Adelaide Wind Farm	22	Sub set	11	6	2015	13:30	14:01	31	1	Anna Corrigan	3	7695	No	Circular	50m radius, 100m by 100m	5-6	14-23	5 to 13	N W	None	40-100	Thundersh owers	Bobolink seen while driving along access road
Adelaide Wind Farm	27	Sub set	11	6	2015	14:11	14:41	30	1	Anna Corrigan	7	7854	No	Circular	50m radius, 100m by 100m	5-6	14-23	5 to 13	N W	None	40-100	Thundersh owers	
Adelaide Wind Farm	27	Sub set	15	6	2015	10:08	10:40	32	1	Anna Corrigan	4	7854	No	Circular	50m radius, 100m by 100m	5-6	23-24	12	W	Drizzl e	60-100	Fog/Rain	Saw 2 Great Blue Herons flying ~200m from turbine
Adelaide Wind Farm	20	Sub set	15	6	2015	10:50	11:21	31	1	Anna Corrigan	4	7854	No	Circular	50m radius, 100m by 100m	5-6	23-24	12	W	Drizzl e	60-100	Fog/Rain	
Adelaide Wind Farm	19	Sub set	15	6	2015	11:30	12:00	30	1	Anna Corrigan	4	7854	No	Circular	50m radius, 100m by 100m	5-6	23-24	12	W	Drizzl e	60-100	Fog/Rain	

**Table F1: Weekly Mortality Monitoring Survey Record**

Project Name	Turbine Number	Treatment Group	Day	Month	Year	Start Time	End Time	Duration Min	Number Of Searchers	Searchers' Names	Days Since Last Search	Actual Area Searched M2	Dog Used	Search Area Shape	Search Area Dimension	Transect Separation M	Temp Celsius	Wind Speed	Wind Direction	Precipitation	Cloud Cover Percentage	Significant Weather	Comments
Adelaide Wind Farm	17	Sub set	15	6	2015	12:08	12:38	30	1	Anna Corrigan	4	3992	No	Circular	50m radius, 100m by 100m	5-6	23-24	12	W	Drizzle	60-100	Fog/Rain	
Adelaide Wind Farm	14	Sub set	15	6	2015	12:46	13:16	30	1	Anna Corrigan	4	7854	No	Circular	50m radius, 100m by 100m	5-6	23-24	12	W	Drizzle	60-100	Fog/Rain	
Adelaide Wind Farm	12	Sub set	15	6	2015	13:23	13:53	30	1	Anna Corrigan	4	7854	No	Circular	50m radius, 100m by 100m	5-6	23-24	12	W	Drizzle	60-100	Fog/Rain	
Adelaide Wind Farm	7	Sub set	15	6	2015	14:03	14:33	30	1	Anna Corrigan	4	6939	No	Circular	50m radius, 100m by 100m	5-6	23-24	12	W	Drizzle	60-100	Fog/Rain	
Adelaide Wind Farm	6	Sub set	15	6	2015	14:41	15:11	30	1	Anna Corrigan	4	4347	No	Circular	50m radius, 100m by 100m	5-6	23-24	12	W	Drizzle	60-100	Fog/Rain	Upon arrival, TUVU flying around survey site, close to ground
Adelaide Wind Farm	11	Sub set	15	6	2015	15:35	16:08	33	1	Anna Corrigan	4	7854	No	Circular	50m radius, 100m by 100m	5-6	23-24	12	W	Drizzle	60-100	Fog/Rain	
Adelaide Wind Farm	27	Sub set	18	6	2015	11:00	12:00	60	1	Ken Edwards	3	7854	No	Circular	50m radius, 100m by 100m	5-6	19	14	SE	None	100	Rain	
Adelaide Wind Farm	22	Sub set	18	6	2015	12:05	12:40	35	1	Ken Edwards	7	4701	No	Circular	50m radius, 100m by 100m	5-6	19	14	SE	None	100	Rain	
Adelaide Wind Farm	20	Sub set	18	6	2015	12:45	13:15	30	1	Ken Edwards	3	7854	No	Circular	50m radius, 100m by 100m	5-6	19	14	SE	None	100	Rain	
Adelaide Wind Farm	19	Sub set	18	6	2015	13:30	14:10	40	1	Ken Edwards	3	7854	No	Circular	50m radius, 100m by 100m	5-6	19	14	SE	None	100	Rain	
Adelaide Wind Farm	17	Sub set	18	6	2015	14:30	15:05	35	1	Ken Edwards	3	2638	No	Circular	50m radius, 100m by 100m	5-6	19	14	SE	None	100	Rain	

**Table F1: Weekly Mortality Monitoring Survey Record**

Project Name	Turbine Number	Treatment Group	Day	Month	Year	Start Time	End Time	Duration Min	Number Of Searchers	Searchers' Names	Days Since Last Search	Actual Area Searched M2	Dog Used	Search Area Shape	Search Area Dimension	Transect Separation M	Temp Celsius	Wind Speed	Wind Direction	Precipitation	Cloud Cover Percentage	Significant Weather	Comments
Adelaide Wind Farm	14	Sub set	18	6	2015	15:15	15:55	40	1	Ken Edwards	3	7854	No	Circular	50m radius, 100m by 100m	5-6	19	14	SE	None	100	Rain	
Adelaide Wind Farm	12	Sub set	18	6	2015	16:05	16:45	35	1	Ken Edwards	3	6821	No	Circular	50m radius, 100m by 100m	5-6	19	14	SE	None	100	Rain	
Adelaide Wind Farm	11	Sub set	18	6	2015	16:55	17:30	45	1	Ken Edwards	3	7854	No	Circular	50m radius, 100m by 100m	5-6	19	14	SE	None	100	Rain	
Adelaide Wind Farm	7	Sub set	18	6	2015	17:45	18:30	45	1	Ken Edwards	3	7432	No	Circular	50m radius, 100m by 100m	5-6	19	14	SE	None	100	Rain	
Adelaide Wind Farm	6	Sub set	18	6	2015	18:40	19:20	40	1	Ken Edwards	3	3423	No	Circular	50m radius, 100m by 100m	5-6	19	14	SE	None	100	Rain	
Adelaide Wind Farm	27	Sub set	22	6	2015	15:30	16:00	30	1	Ken Edwards	4	7854	No	Circular	50m radius, 100m by 100m	5-6	15-26	20	S	None	50	Rain	
Adelaide Wind Farm	22	Sub set	22	6	2015	16:05	16:45	35	1	Ken Edwards	4	4701	No	Circular	50m radius, 100m by 100m	5-6	15-26	20	S	None	50	Rain	
Adelaide Wind Farm	20	Sub set	22	6	2015	16:50	17:30	40	1	Ken Edwards	4	7854	No	Circular	50m radius, 100m by 100m	5-6	15-26	20	S	None	50	Rain	
Adelaide Wind Farm	19	Sub set	22	6	2015	17:40	18:20	40	1	Ken Edwards	4	7854	No	Circular	50m radius, 100m by 100m	5-6	15-26	20	S	None	50	Rain	
Adelaide Wind Farm	17	Sub set	22	6	2015	18:30	19:00	30	1	Ken Edwards	4	2638	No	Circular	50m radius, 100m by 100m	5-6	15-26	20	S	None	50	Rain	
Adelaide Wind Farm	12	Sub set	22	6	2015	19:10	19:45	35	1	Ken Edwards	4	6821	No	Circular	50m radius, 100m by 100m	5-6	15-26	20	S	None	50	Rain	
Adelaide Wind Farm	6	Sub set	22	6	2015	19:55	20:30	35	1	Ken Edwards	4	3423	No	Circular	50m radius, 100m by 100m	5-6	15-26	20	S	None	50	Rain	

**Table F1: Weekly Mortality Monitoring Survey Record**

Project Name	Turbine Number	Treatment Group	Day	Month	Year	Start Time	End Time	Duration Min	Number Of Searchers	Searchers' Names	Days Since Last Search	Actual Area Searched M2	Dog Used	Search Area Shape	Search Area Dimension	Transect Separation M	Temp Celsius	Wind Speed	Wind Direction	Precipitation	Cloud Cover Percentage	Significant Weather	Comments
Adelaide Wind Farm	6	Sub set	25	6	2015	8:40	9:10	30	1	Ken Edwards	3	3423	No	Circular	50m radius, 100m by 100m	5-6	24	6	S	None	100	None	
Adelaide Wind Farm	7	Sub set	25	6	2015	9:15	9:55	40	1	Ken Edwards	7	7854	No	Circular	50m radius, 100m by 100m	5-6	24	6	S	None	100	None	
Adelaide Wind Farm	11	Sub set	25	6	2015	10:00	10:35	35	1	Ken Edwards	7	7854	No	Circular	50m radius, 100m by 100m	5-6	24	6	S	None	100	None	
Adelaide Wind Farm	14	Sub set	25	6	2015	10:40	11:15	35	1	Ken Edwards	7	7854	No	Circular	50m radius, 100m by 100m	5-6	24	6	S	None	100	None	
Adelaide Wind Farm	19	Sub set	25	6	2015	11:25	12:00	35	1	Ken Edwards	3	7854	No	Circular	50m radius, 100m by 100m	5-6	24	6	S	None	100	None	
Adelaide Wind Farm	20	Sub set	25	6	2015	12:30	13:10	40	1	Ken Edwards	3	7854	No	Circular	50m radius, 100m by 100m	5-6	24	6	S	None	100	None	
Adelaide Wind Farm	22	Sub set	25	6	2015	13:25	14:05	40	1	Ken Edwards	3	4701	No	Circular	50m radius, 100m by 100m	5-6	24	6	S	None	100	None	
Adelaide Wind Farm	27	Sub set	25	6	2015	14:10	14:45	35	1	Ken Edwards	3	7854	No	Circular	50m radius, 100m by 100m	5-6	24	6	S	None	100	None	
Adelaide Wind Farm	6	Sub set	29	6	2015	8:30	9:10	40	1	Ken Edwards	4	3423	No	Circular	50m radius, 100m by 100m	5-6	19-25	6	S	None	30	Rain	
Adelaide Wind Farm	7	Sub set	29	6	2015	9:18	10:00	42	1	Ken Edwards	4	7854	No	Circular	50m radius, 100m by 100m	5-6	19-25	6	S	None	30	Rain	
Adelaide Wind Farm	11	Sub set	29	6	2015	10:10	11:00	50	1	Ken Edwards	4	7854	No	Circular	50m radius, 100m by 100m	5-6	19-25	6	S	None	30	Rain	
Adelaide Wind Farm	14	Sub set	29	6	2015	11:10	12:00	50	1	Ken Edwards	4	7854	No	Circular	50m radius, 100m by 100m	5-6	19-25	6	S	None	30	Rain	



**Table F1: Weekly Mortality Monitoring Survey Record**

Project Name	Turbine Number	Treatment Group	Day	Month	Year	Start Time	End Time	Duration Min	Number Of Searchers	Searchers' Names	Days Since Last Search	Actual Area Searched M2	Dog Used	Search Area Shape	Search Area Dimension	Transect Separation M	Temp Celsius	Wind Speed	Wind Direction	Precipitation	Cloud Cover Percentage	Significant Weather	Comments
Adelaide Wind Farm	17	Sub set	29	6	2015	12:35	13:10	35	1	Ken Edwards	7	4639	No	Circular	50m radius, 100m by 100m	5-6	19-25	6	S	None	30	Rain	
Adelaide Wind Farm	19	Sub set	29	6	2015	13:15	13:45	30	1	Ken Edwards	4	7854	No	Circular	50m radius, 100m by 100m	5-6	19-25	6	S	None	30	Rain	
Adelaide Wind Farm	20	Sub set	29	6	2015	13:55	14:30	35	1	Ken Edwards	4	7854	No	Circular	50m radius, 100m by 100m	5-6	19-25	6	S	None	30	Rain	
Adelaide Wind Farm	22	Sub set	29	6	2015	14:40	15:20	40	1	Ken Edwards	4	4701	No	Circular	50m radius, 100m by 100m	5-6	19-25	6	S	None	30	Rain	
Adelaide Wind Farm	27	Sub set	29	6	2015	15:30	16:05	35	1	Ken Edwards	4	7854	No	Circular	50m radius, 100m by 100m	5-6	19-25	6	S	None	30	Rain	
Adelaide Wind Farm	6	Sub set	2	7	2015	8:30	9:05	35	1	Ken Edwards	3	3423	No	Circular	50m radius, 100m by 100m	5-6	16-21	5	N	None	10	None	
Adelaide Wind Farm	11	Sub set	2	7	2015	9:15	10:20	65	1	Ken Edwards	3	7854	No	Circular	50m radius, 100m by 100m	5-6	16-21	5	N	None	10	None	
Adelaide Wind Farm	12	Sub set	2	7	2015	10:30	11:20	50	1	Ken Edwards	10	6821	No	Circular	50m radius, 100m by 100m	5-6	16-21	5	N	None	10	None	
Adelaide Wind Farm	20	Sub set	2	7	2015	11:35	12:20	45	1	Ken Edwards	3	7854	No	Circular	50m radius, 100m by 100m	5-6	16-21	5	N	None	10	None	
Adelaide Wind Farm	22	Sub set	2	7	2015	12:30	13:15	45	1	Ken Edwards	3	4701	No	Circular	50m radius, 100m by 100m	5-6	16-21	5	N	None	10	None	
Adelaide Wind Farm	27	Sub set	2	7	2015	13:30	14:00	30	1	Ken Edwards	3	7854	No	Circular	50m radius, 100m by 100m	5-6	16-21	5	N	None	10	None	
Adelaide Wind Farm	17	Sub set	2	7	2015	14:15	14:55	40	1	Ken Edwards	3	4639	No	Circular	50m radius, 100m by 100m	5-6	16-21	5	N	None	10	None	

**Table F1: Weekly Mortality Monitoring Survey Record**

Project Name	Turbine Number	Treatment Group	Day	Month	Year	Start Time	End Time	Duration Min	Number Of Searchers	Searchers' Names	Days Since Last Search	Actual Area Searched M2	Dog Used	Search Area Shape	Search Area Dimension	Transect Separation M	Temp Celsius	Wind Speed	Wind Direction	Precipitation	Cloud Cover Percentage	Significant Weather	Comments
Adelaide Wind Farm	14	Sub set	2	7	2015	15:10	15:00	50	1	Ken Edwards	3	7854	No	Circular	50m radius, 100m by 100m	5-6	16-21	5	N	None	10	None	
Adelaide Wind Farm	19	Sub set	2	7	2015	16:10	16:45	35	1	Ken Edwards	3	7854	No	Circular	50m radius, 100m by 100m	5-6	16-21	5	N	None	10	None	
Adelaide Wind Farm	6	Sub set	6	7	2015	8:30	9:10	40	1	Ken Edwards	4	3423	No	Circular	50m radius, 100m by 100m	5-6	27	15	SE	None	0	None	
Adelaide Wind Farm	11	Sub set	6	7	2015	9:25	10:10	45	1	Ken Edwards	4	7854	No	Circular	50m radius, 100m by 100m	5-6	27	15	SE	None	0	None	
Adelaide Wind Farm	12	Sub set	6	7	2015	10:15	11:05	50	1	Ken Edwards	4	6821	No	Circular	50m radius, 100m by 100m	5-6	27	15	SE	None	0	None	
Adelaide Wind Farm	19	Sub set	6	7	2015	11:35	12:10	35	1	Ken Edwards	4	7854	No	Circular	50m radius, 100m by 100m	5-6	27	15	SE	None	0	None	
Adelaide Wind Farm	20	Sub set	6	7	2015	12:20	12:50	30	1	Ken Edwards	4	7854	No	Circular	50m radius, 100m by 100m	5-6	27	15	SE	None	0	None	
Adelaide Wind Farm	22	Sub set	6	7	2015	13:00	13:30	30	1	Ken Edwards	4	4701	No	Circular	50m radius, 100m by 100m	5-6	27	15	SE	None	0	None	
Adelaide Wind Farm	27	Sub set	6	7	2015	13:40	14:15	35	1	Ken Edwards	4	7854	No	Circular	50m radius, 100m by 100m	5-6	27	15	SE	None	0	None	
Adelaide Wind Farm	17	Sub set	6	7	2015	14:25	15:00	35	1	Ken Edwards	4	4639	No	Circular	50m radius, 100m by 100m	5-6	27	15	SE	None	0	None	
Adelaide Wind Farm	14	Sub set	6	7	2015	15:10	15:50	40	1	Ken Edwards	4	7854	No	Circular	50m radius, 100m by 100m	5-6	27	15	SE	None	0	None	
Adelaide Wind Farm	6	Sub set	9	7	2015	8:30	9:20	50	1	Ken Edwards	3	5368	No	Circular	50m radius, 100m by 100m	5-6	18	6	E	Light Rain	80	Light Rain	

**Table F1: Weekly Mortality Monitoring Survey Record**

Project Name	Turbine Number	Treatment Group	Day	Month	Year	Start Time	End Time	Duration Min	Number Of Searchers	Searchers' Names	Days Since Last Search	Actual Area Searched M2	Dog Used	Search Area Shape	Search Area Dimension	Transect Separation M	Temp Celsius	Wind Speed	Wind Direction	Precipitation	Cloud Cover Percentage	Significant Weather	Comments
Adelaide Wind Farm	7	Sub set	9	7	2015	9:30	10:10	40	1	Ken Edwards	10	7854	No	Circular	50m radius, 100m by 100m	5-6	18	6	E	Light Rain	80	Light Rain	
Adelaide Wind Farm	11	Sub set	9	7	2015	10:25	11:15	50	1	Ken Edwards	3	6978	No	Circular	50m radius, 100m by 100m	5-6	18	6	E	Light Rain	80	Light Rain	
Adelaide Wind Farm	12	Sub set	9	7	2015	11:25	12:15	50	1	Ken Edwards	3	6821	No	Circular	50m radius, 100m by 100m	5-6	18	6	E	Light Rain	80	Light Rain	
Adelaide Wind Farm	14	Sub set	9	7	2015	12:25	13:15	50	1	Ken Edwards	3	7854	No	Circular	50m radius, 100m by 100m	5-6	18	6	E	Light Rain	80	Light Rain	
Adelaide Wind Farm	17	Sub set	9	7	2015	13:45	14:45	60	1	Ken Edwards	3	4639	No	Circular	50m radius, 100m by 100m	5-6	18	6	E	Light Rain	80	Light Rain	
Adelaide Wind Farm	19	Sub set	9	7	2015	14:55	15:40	45	1	Ken Edwards	3	7854	No	Circular	50m radius, 100m by 100m	5-6	18	6	E	Light Rain	80	Light Rain	
Adelaide Wind Farm	20	Sub set	9	7	2015	15:50	16:25	35	1	Ken Edwards	3	7854	No	Circular	50m radius, 100m by 100m	5-6	18	6	E	Light Rain	80	Light Rain	
Adelaide Wind Farm	27	Sub set	9	7	2015	17:35	17:15	40	1	Ken Edwards	3	7854	No	Circular	50m radius, 100m by 100m	5-6	18	6	E	Light Rain	80	Light Rain	
Adelaide Wind Farm	6	Sub set	13	7	2015	8:30	9:20	50	1	Ken Edwards	4	5368	No	Circular	50m radius, 100m by 100m	5-6	20-27	13	SE	None	0	None	
Adelaide Wind Farm	11	Sub set	13	7	2015	9:35	10:25	50	1	Ken Edwards	4	7854	No	Circular	50m radius, 100m by 100m	5-6	20-27	13	SE	None	0	None	
Adelaide Wind Farm	14	Sub set	13	7	2015	10:35	11:20	45	1	Ken Edwards	4	7854	No	Circular	50m radius, 100m by 100m	5-6	20-27	13	SE	None	0	None	
Adelaide Wind Farm	17	Sub set	13	7	2015	11:30	12:15	45	1	Ken Edwards	4	4639	No	Circular	50m radius, 100m by 100m	5-6	20-27	13	SE	None	0	None	

**Table F1: Weekly Mortality Monitoring Survey Record**

Project Name	Turbine Number	Treatment Group	Day	Month	Year	Start Time	End Time	Duration Min	Number Of Searchers	Searchers' Names	Days Since Last Search	Actual Area Searched M2	Dog Used	Search Area Shape	Search Area Dimension	Transect Separation M	Temp Celsius	Wind Speed	Wind Direction	Precipitation	Cloud Cover Percentage	Significant Weather	Comments
Adelaide Wind Farm	27	Sub set	13	7	2015	12:45	13:30	45	1	Ken Edwards	4	7854	No	Circular	50m radius, 100m by 100m	5-6	20-27	13	SE	None	0	None	
Adelaide Wind Farm	22	Sub set	13	7	2015	13:45	14:20	35	1	Ken Edwards	7	5268	No	Circular	50m radius, 100m by 100m	5-6	20-27	13	SE	None	0	None	
Adelaide Wind Farm	20	Sub set	13	7	2015	14:30	15:05	35	1	Ken Edwards	4	7854	No	Circular	50m radius, 100m by 100m	5-6	20-27	13	SE	None	0	None	
Adelaide Wind Farm	19	Sub set	13	7	2015	15:20	16:00	40	1	Ken Edwards	4	7854	No	Circular	50m radius, 100m by 100m	5-6	20-27	13	SE	None	0	None	
Adelaide Wind Farm	12	Sub set	13	7	2015	16:30	17:00	30	1	Ken Edwards	4	2928	No	Circular	50m radius, 100m by 100m	5-6	20-27	13	SE	None	0	None	
Adelaide Wind Farm	7	Sub set	13	7	2015	17:15	18:05	50	1	Ken Edwards	4	7012	No	Circular	50m radius, 100m by 100m	5-6	20-27	13	SE	None	0	None	
Adelaide Wind Farm	6	Sub set	16	7	2015	8:35	9:20	45	1	Ken Edwards	3	5368	No	Circular	50m radius, 100m by 100m	5-6	18-23	10	SE	None	0	None	
Adelaide Wind Farm	7	Sub set	16	7	2015	9:30	10:10	40	1	Ken Edwards	3	7012	No	Circular	50m radius, 100m by 100m	5-6	18-23	10	SE	None	0	None	
Adelaide Wind Farm	11	Sub set	16	7	2015	10:20	11:10	50	1	Ken Edwards	3	7854	No	Circular	50m radius, 100m by 100m	5-6	18-23	10	SE	None	0	None	
Adelaide Wind Farm	12	Sub set	16	7	2015	11:40	12:40	60	1	Ken Edwards	3	2438	No	Circular	50m radius, 100m by 100m	5-6	18-23	10	SE	None	0	None	
Adelaide Wind Farm	14	Sub set	16	7	2015	12:50	13:40	50	1	Ken Edwards	3	7854	No	Circular	50m radius, 100m by 100m	5-6	18-23	10	SE	None	0	None	
Adelaide Wind Farm	17	Sub set	16	7	2015	13:50	14:40	50	1	Ken Edwards	3	4639	No	Circular	50m radius, 100m by 100m	5-6	18-23	10	SE	None	0	None	

**Table F1: Weekly Mortality Monitoring Survey Record**

Project Name	Turbine Number	Treatment Group	Day	Month	Year	Start Time	End Time	Duration Min	Number Of Searchers	Searchers' Names	Days Since Last Search	Actual Area Searched M2	Dog Used	Search Area Shape	Search Area Dimension	Transect Separation M	Temp Celsius	Wind Speed	Wind Direction	Precipitation	Cloud Cover Percentage	Significant Weather	Comments
Adelaide Wind Farm	19	Sub set	16	7	2015	14:50	15:30	40	1	Ken Edwards	3	7854	No	Circular	50m radius, 100m by 100m	5-6	18-23	10	SE	None	0	None	
Adelaide Wind Farm	20	Sub set	16	7	2015	15:40	16:20	40	1	Ken Edwards	3	7854	No	Circular	50m radius, 100m by 100m	5-6	18-23	10	SE	None	0	None	
Adelaide Wind Farm	22	Sub set	16	7	2015	16:30	17:00	30	1	Ken Edwards	3	5268	No	Circular	50m radius, 100m by 100m	5-6	18-23	10	SE	None	0	None	
Adelaide Wind Farm	27	Sub set	16	7	2015	17:10	17:55	45	1	Ken Edwards	3	7854	No	Circular	50m radius, 100m by 100m	5-6	18-23	10	SE	None	0	None	
Adelaide Wind Farm	27	Sub set	20	7	2015	9:30	10:10	40	1	Ken Edwards	4	7854	No	Circular	50m radius, 100m by 100m	5-6	27	14	SW	None	20	Rain	
Adelaide Wind Farm	22	Sub set	20	7	2015	10:20	10:50	30	1	Ken Edwards	4	5268	No	Circular	50m radius, 100m by 100m	5-6	27	14	SW	None	20	Rain	
Adelaide Wind Farm	20	Sub set	20	7	2015	11:00	11:30	30	1	Ken Edwards	4	7854	No	Circular	50m radius, 100m by 100m	5-6	27	14	SW	None	20	Rain	
Adelaide Wind Farm	19	Sub set	20	7	2015	11:40	12:25	45	1	Ken Edwards	4	6411	No	Circular	50m radius, 100m by 100m	5-6	27	14	SW	None	20	Rain	
Adelaide Wind Farm	17	Sub set	20	7	2015	12:35	13:15	40	1	Ken Edwards	4	4639	No	Circular	50m radius, 100m by 100m	5-6	27	14	SW	None	20	Rain	
Adelaide Wind Farm	14	Sub set	20	7	2015	13:25	14:00	35	1	Ken Edwards	4	4856	No	Circular	50m radius, 100m by 100m	5-6	27	14	SW	None	20	Rain	
Adelaide Wind Farm	12	Sub set	20	7	2015	14:10	14:50	40	1	Ken Edwards	4	2438	No	Circular	50m radius, 100m by 100m	5-6	27	14	SW	None	20	Rain	
Adelaide Wind Farm	11	Sub set	20	7	2015	15:10	15:40	30	1	Ken Edwards	4	2378	No	Circular	50m radius, 100m by 100m	5-6	27	14	SW	None	20	Rain	

**Table F1: Weekly Mortality Monitoring Survey Record**

Project Name	Turbine Number	Treatment Group	Day	Month	Year	Start Time	End Time	Duration Min	Number Of Searchers	Searchers' Names	Days Since Last Search	Actual Area Searched M2	Dog Used	Search Area Shape	Search Area Dimension	Transect Separation M	Temp Celsius	Wind Speed	Wind Direction	Precipitation	Cloud Cover Percentage	Significant Weather	Comments
Adelaide Wind Farm	7	Sub set	20	7	2015	16:05	16:45	40	1	Ken Edwards	4	6629	No	Circular	50m radius, 100m by 100m	5-6	27	14	SW	None	20	Rain	
Adelaide Wind Farm	6	Sub set	20	7	2015	16:55	17:30	35	1	Ken Edwards	4	5368	No	Circular	50m radius, 100m by 100m	5-6	27	14	SW	None	20	Rain	
Adelaide Wind Farm	6	Sub set	23	7	2015	8:50	9:35	45	1	Ken Edwards	3	6542	No	Circular	50m radius, 100m by 100m	5-6	20-24	10	N W	None	0	None	
Adelaide Wind Farm	7	Sub set	23	7	2015	9:45	10:35	50	1	Ken Edwards	3	6629	No	Circular	50m radius, 100m by 100m	5-6	20-24	10	N W	None	0	None	
Adelaide Wind Farm	11	Sub set	23	7	2015	10:45	11:15	30	1	Ken Edwards	3	2378	No	Circular	50m radius, 100m by 100m	5-6	20-24	10	N W	None	0	None	
Adelaide Wind Farm	14	Sub set	23	7	2015	11:25	12:05	40	1	Ken Edwards	3	4856	No	Circular	50m radius, 100m by 100m	5-6	20-24	10	N W	None	0	None	
Adelaide Wind Farm	17	Sub set	23	7	2015	12:15	13:05	50	1	Ken Edwards	3	4639	No	Circular	50m radius, 100m by 100m	5-6	20-24	10	N W	None	0	None	
Adelaide Wind Farm	19	Sub set	23	7	2015	13:15	14:00	45	1	Ken Edwards	3	6411	No	Circular	50m radius, 100m by 100m	5-6	20-24	10	N W	None	0	None	
Adelaide Wind Farm	22	Sub set	23	7	2015	14:10	14:40	30	1	Ken Edwards	3	5268	No	Circular	50m radius, 100m by 100m	5-6	20-24	10	N W	None	0	None	
Adelaide Wind Farm	27	Sub set	23	7	2015	14:50	15:40	50	1	Ken Edwards	3	7854	No	Circular	50m radius, 100m by 100m	5-6	20-24	10	N W	None	0	None	
Adelaide Wind Farm	12	Sub set	23	7	2015	15:30	16:40	50	1	Ken Edwards	3	2438	No	Circular	50m radius, 100m by 100m	5-6	20-24	10	N W	None	0	None	
Adelaide Wind Farm	6	Sub set	27	7	2015	8:40	9:25	45	1	Ken Edwards	4	6524	No	Circular	50m radius, 100m by 100m	5-6	27-31	2	SE	None	0	None	

**Table F1: Weekly Mortality Monitoring Survey Record**

Project Name	Turbine Number	Treatment Group	Day	Month	Year	Start Time	End Time	Duration Min	Number Of Searchers	Searchers' Names	Days Since Last Search	Actual Area Searched M2	Dog Used	Search Area Shape	Search Area Dimension	Transect Separation M	Temp Celsius	Wind Speed	Wind Direction	Precipitation	Cloud Cover Percentage	Significant Weather	Comments
Adelaide Wind Farm	7	Sub set	27	7	2015	9:35	10:10	35	1	Ken Edwards	4	6629	No	Circular	50m radius, 100m by 100m	5-6	27-31	2	SE	None	0	None	
Adelaide Wind Farm	12	Sub set	27	7	2015	10:20	11:00	40	1	Ken Edwards	4	2378	No	Circular	50m radius, 100m by 100m	5-6	27-31	2	SE	None	0	None	
Adelaide Wind Farm	14	Sub set	27	7	2015	11:05	11:35	30	1	Ken Edwards	4	4856	No	Circular	50m radius, 100m by 100m	5-6	27-31	2	SE	None	0	None	
Adelaide Wind Farm	17	Sub set	27	7	2015	11:45	12:30	45	1	Ken Edwards	4	4639	No	Circular	50m radius, 100m by 100m	5-6	27-31	2	SE	None	0	None	
Adelaide Wind Farm	19	Sub set	27	7	2015	13:00	13:45	45	1	Ken Edwards	4	6411	No	Circular	50m radius, 100m by 100m	5-6	27-31	2	SE	None	0	None	
Adelaide Wind Farm	22	Sub set	27	7	2015	13:55	14:34	40	1	Ken Edwards	4	5268	No	Circular	50m radius, 100m by 100m	5-6	27-31	2	SE	None	0	None	
Adelaide Wind Farm	27	Sub set	27	7	2015	14:45	15:15	30	1	Ken Edwards	4	7854	No	Circular	50m radius, 100m by 100m	5-6	27-31	2	SE	None	0	None	
Adelaide Wind Farm	11	Sub set	27	7	2015	15:30	16:00	30	1	Ken Edwards	4	2436	No	Circular	50m radius, 100m by 100m	5-6	27-31	2	SE	None	0	None	
Adelaide Wind Farm	6	Sub set	30	7	2015	8:40	9:10	40	1	Ken Edwards	3	6524	No	Circular	50m radius, 100m by 100m	5-6	19-30	14	W	None	0	Light Rain	
Adelaide Wind Farm	7	Sub set	30	7	2015	9:20	10:10	40	1	Ken Edwards	3	6629	No	Circular	50m radius, 100m by 100m	5-6	19-30	14	W	None	0	Light Rain	
Adelaide Wind Farm	11	Sub set	30	7	2015	10:15	10:45	30	1	Ken Edwards	3	2436	No	Circular	50m radius, 100m by 100m	5-6	19-30	14	W	None	0	Light Rain	
Adelaide Wind Farm	12	Sub set	30	7	2015	10:55	11:35	40	1	Ken Edwards	3	2378	No	Circular	50m radius, 100m by 100m	5-6	19-30	14	W	None	0	Light Rain	

**Table F1: Weekly Mortality Monitoring Survey Record**

Project Name	Turbine Number	Treatment Group	Day	Month	Year	Start Time	End Time	Duration Min	Number Of Searchers	Searchers' Names	Days Since Last Search	Actual Area Searched M2	Dog Used	Search Area Shape	Search Area Dimension	Transect Separation M	Temp Celsius	Wind Speed	Wind Direction	Precipitation	Cloud Cover Percentage	Significant Weather	Comments
Adelaide Wind Farm	17	Sub set	30	7	2015	11:55	12:45	50	1	Ken Edwards	3	4639	No	Circular	50m radius, 100m by 100m	5-6	19-30	14	W	None	0	Light Rain	
Adelaide Wind Farm	19	Sub set	30	7	2015	12:55	13:40	45	1	Ken Edwards	3	6411	No	Circular	50m radius, 100m by 100m	5-6	19-30	14	W	None	0	Light Rain	
Adelaide Wind Farm	20	Sub set	30	7	2015	13:55	14:45	50	1	Ken Edwards	10	7854	No	Circular	50m radius, 100m by 100m	5-6	19-30	14	W	None	0	Light Rain	
Adelaide Wind Farm	22	Sub set	30	7	2015	14:55	15:30	35	1	Ken Edwards	3	5268	No	Circular	50m radius, 100m by 100m	5-6	19-30	14	W	None	0	Light Rain	
Adelaide Wind Farm	27	Sub set	30	7	2015	15:40	16:30	50	1	Ken Edwards	3	7432	No	Circular	50m radius, 100m by 100m	5-6	19-30	14	W	None	0	Light Rain	
Adelaide Wind Farm	6	Sub set	4	8	2015	8:45	9:35	50	1	Ken Edwards	4	6524	No	Circular	50m radius, 100m by 100m	5-6	22-24	5	N W	None	30	None	
Adelaide Wind Farm	7	Sub set	4	8	2015	9:45	10:15	30	1	Ken Edwards	4	6629	No	Circular	50m radius, 100m by 100m	5-6	22-24	5	N W	None	30	None	
Adelaide Wind Farm	11	Sub set	4	8	2015	10:25	10:55	30	1	Ken Edwards	4	2436	No	Circular	50m radius, 100m by 100m	5-6	22-24	5	N W	None	30	None	
Adelaide Wind Farm	12	Sub set	4	8	2015	11:05	11:35	30	1	Ken Edwards	4	6895	No	Circular	50m radius, 100m by 100m	5-6	22-24	5	N W	None	30	None	
Adelaide Wind Farm	17	Sub set	4	8	2015	11:45	12:15	30	1	Ken Edwards	4	7854	No	Circular	50m radius, 100m by 100m	5-6	22-24	5	N W	None	30	None	
Adelaide Wind Farm	19	Sub set	4	8	2015	12:25	12:55	30	1	Ken Edwards	4	6411	No	Circular	50m radius, 100m by 100m	5-6	22-24	5	N W	None	30	None	
Adelaide Wind Farm	20	Sub set	4	8	2015	13:05	13:45	40	1	Ken Edwards	4	7854	No	Circular	50m radius, 100m by 100m	5-6	22-24	5	N W	None	30	None	



**Table F1: Weekly Mortality Monitoring Survey Record**

Project Name	Turbine Number	Treatment Group	Day	Month	Year	Start Time	End Time	Duration Min	Number Of Searchers	Searchers' Names	Days Since Last Search	Actual Area Searched M2	Dog Used	Search Area Shape	Search Area Dimension	Transect Separation M	Temp Celsius	Wind Speed	Wind Direction	Precipitation	Cloud Cover Percentage	Significant Weather	Comments
Adelaide Wind Farm	22	Sub set	4	8	2015	13:55	14:45	50	1	Ken Edwards	4	5268	No	Circular	50m radius, 100m by 100m	5-6	22-24	5	N W	None	30	None	
Adelaide Wind Farm	27	Sub set	4	8	2015	14:55	15:25	30	1	Ken Edwards	4	7432	No	Circular	50m radius, 100m by 100m	5-6	22-24	5	N W	None	30	None	
Adelaide Wind Farm	14	Sub set	4	8	2015	15:40	16:10	30	1	Ken Edwards	7	3925	No	Circular	50m radius, 100m by 100m	5-6	22-24	5	N W	None	30	None	
Adelaide Wind Farm	6	Sub set	7	8	2015	8:45	9:15	45	1	Ken Edwards	3	6524	No	Circular	50m radius, 100m by 100m	5-6	26	6	E	None	20	None	
Adelaide Wind Farm	7	Sub set	7	8	2015	9:25	9:55	30	1	Ken Edwards	3	6629	No	Circular	50m radius, 100m by 100m	5-6	26	6	E	None	20	None	
Adelaide Wind Farm	11	Sub set	7	8	2015	10:05	10:35	30	1	Ken Edwards	3	1436	No	Circular	50m radius, 100m by 100m	5-6	26	6	E	None	20	None	
Adelaide Wind Farm	12	Sub set	7	8	2015	10:45	11:30	45	1	Ken Edwards	3	9895	No	Circular	50m radius, 100m by 100m	5-6	26	6	E	None	20	None	
Adelaide Wind Farm	14	Sub set	7	8	2015	11:40	12:15	35	1	Ken Edwards	3	3925	No	Circular	50m radius, 100m by 100m	5-6	26	6	E	None	20	None	
Adelaide Wind Farm	17	Sub set	7	8	2015	12:25	13:05	40	1	Ken Edwards	3	7854	No	Circular	50m radius, 100m by 100m	5-6	26	6	E	None	20	None	
Adelaide Wind Farm	19	Sub set	7	8	2015	13:15	13:50	35	1	Ken Edwards	3	6411	No	Circular	50m radius, 100m by 100m	5-6	26	6	E	None	20	None	
Adelaide Wind Farm	20	Sub set	7	8	2015	14:00	14:35	35	1	Ken Edwards	3	7854	No	Circular	50m radius, 100m by 100m	5-6	26	6	E	None	20	None	
Adelaide Wind Farm	22	Sub set	7	8	2015	14:45	15:15	30	1	Ken Edwards	3	5267	No	Circular	50m radius, 100m by 100m	5-6	26	6	E	None	20	None	

**Table F1: Weekly Mortality Monitoring Survey Record**

Project Name	Turbine Number	Treatment Group	Day	Month	Year	Start Time	End Time	Duration Min	Number Of Searchers	Searchers' Names	Days Since Last Search	Actual Area Searched M2	Dog Used	Search Area Shape	Search Area Dimension	Transect Separation M	Temp Celsius	Wind Speed	Wind Direction	Precipitation	Cloud Cover Percentage	Significant Weather	Comments
Adelaide Wind Farm	27	Sub set	7	8	2015	15:25	15:55	30	1	Ken Edwards	3	7432	No	Circular	50m radius, 100m by 100m	5-6	26	6	E	None	20	None	
Adelaide Wind Farm	6	Sub set	10	8	2015	8:45	9:40	55	1	Ken Edwards	4	6524	No	Circular	50m radius, 100m by 100m	5-6	17-25	6	E	Light Rain	100	None	
Adelaide Wind Farm	7	Sub set	10	8	2015	9:50	10:25	35	1	Ken Edwards	4	6629	No	Circular	50m radius, 100m by 100m	5-6	17-25	6	E	Light Rain	100	None	
Adelaide Wind Farm	11	Sub set	10	8	2015	13:35	11:05	30	1	Ken Edwards	4	2436	No	Circular	50m radius, 100m by 100m	5-6	17-25	6	E	Light Rain	100	None	
Adelaide Wind Farm	12	Sub set	10	8	2015	11:10	11:50	40	1	Ken Edwards	4	6895	No	Circular	50m radius, 100m by 100m	5-6	17-25	6	E	Light Rain	100	None	
Adelaide Wind Farm	14	Sub set	10	8	2015	12:05	12:55	50	1	Ken Edwards	4	3925	No	Circular	50m radius, 100m by 100m	5-6	17-25	6	E	Light Rain	100	None	
Adelaide Wind Farm	17	Sub set	11	8	2015	10:35	11:15	40	1	Ken Edwards	5	7854	No	Circular	50m radius, 100m by 100m	5-6	20-22	18	N W	None	80	Thunderstorms	Survey moved a day later due to thunderstorms previous day making it unsafe to survey.
Adelaide Wind Farm	19	Sub set	11	8	2015	11:25	12:05	40	1	Ken Edwards	5	6411	No	Circular	50m radius, 100m by 100m	5-6	20-22	18	N W	None	80	Thunderstorms	Survey moved a day later due to thunderstorms previous day making it unsafe to survey.

**Table F1: Weekly Mortality Monitoring Survey Record**

Project Name	Turbine Number	Treatment Group	Day	Month	Year	Start Time	End Time	Duration Min	Number Of Searchers	Searchers' Names	Days Since Last Search	Actual Area Searched M2	Dog Used	Search Area Shape	Search Area Dimension	Transect Separation M	Temp Celsius	Wind Speed	Wind Direction	Precipitation	Cloud Cover Percentage	Significant Weather	Comments
Adelaide Wind Farm	20	Sub set	11	8	2015	12:20	13:10	50	1	Ken Edwards	5	7854	No	Circular	50m radius, 100m by 100m	5-6	20-22	18	N W	None	80	Thunderstorms	Survey moved a day later due to thunderstorms previous day making it unsafe to survey.
Adelaide Wind Farm	22	Sub set	11	8	2015	13:20	13:55	35	1	Ken Edwards	5	5267	No	Circular	50m radius, 100m by 100m	5-6	20-22	18	N W	None	80	Thunderstorms	Survey moved a day later due to thunderstorms previous day making it unsafe to survey.
Adelaide Wind Farm	27	Sub set	11	8	2015	14:00	14:30	30	1	Ken Edwards	5	7432	No	Circular	50m radius, 100m by 100m	5-6	20-22	18	N W	None	80	Thunderstorms	Survey moved a day later due to thunderstorms previous day making it unsafe to survey.
Adelaide Wind Farm	6	Sub set	13	8	2015	8:40	9:25	45	1	Ken Edwards	3	6524	No	Circular	50m radius, 100m by 100m	5-6	15-25	3	S	None	30	None	
Adelaide Wind Farm	7	Sub set	13	8	2015	9:35	10:20	45	1	Ken Edwards	3	6629	No	Circular	50m radius, 100m by 100m	5-6	15-25	3	S	None	30	None	
Adelaide Wind Farm	11	Sub set	13	8	2015	10:25	11:00	35	1	Ken Edwards	3	2436	No	Circular	50m radius, 100m by 100m	5-6	15-25	3	S	None	30	None	
Adelaide Wind Farm	12	Sub set	13	8	2015	11:10	11:40	30	1	Ken Edwards	3	6895	No	Circular	50m radius, 100m by 100m	5-6	15-25	3	S	None	30	None	

**Table F1: Weekly Mortality Monitoring Survey Record**

Project Name	Turbine Number	Treatment Group	Day	Month	Year	Start Time	End Time	Duration Min	Number Of Searchers	Searchers' Names	Days Since Last Search	Actual Area Searched M2	Dog Used	Search Area Shape	Search Area Dimension	Transect Separation M	Temp Celsius	Wind Speed	Wind Direction	Precipitation	Cloud Cover Percentage	Significant Weather	Comments
Adelaide Wind Farm	14	Sub set	13	8	2015	11:50	12:20	30	1	Ken Edwards	3	3925	No	Circular	50m radius, 100m by 100m	5-6	15-25	3	S	None	30	None	
Adelaide Wind Farm	17	Sub set	13	8	2015	12:50	13:20	30	1	Ken Edwards	2	7854	No	Circular	50m radius, 100m by 100m	5-6	15-25	3	S	None	30	None	
Adelaide Wind Farm	19	Sub set	13	8	2015	13:30	14:10	40	1	Ken Edwards	2	6411	No	Circular	50m radius, 100m by 100m	5-6	15-25	3	S	None	30	None	
Adelaide Wind Farm	20	Sub set	13	8	2015	14:20	14:50	30	1	Ken Edwards	2	7854	No	Circular	50m radius, 100m by 100m	5-6	15-25	3	S	None	30	None	
Adelaide Wind Farm	22	Sub set	13	8	2015	15:00	15:30	30	1	Ken Edwards	2	5267	No	Circular	50m radius, 100m by 100m	5-6	15-25	3	S	None	30	None	
Adelaide Wind Farm	27	Sub set	13	8	2015	15:40	16:10	30	1	Ken Edwards	2	7432	No	Circular	50m radius, 100m by 100m	5-6	15-25	3	S	None	30	None	
Adelaide Wind Farm	6	Sub set	17	8	2015	8:45	9:20	35	1	Ken Edwards	4	6524	No	Circular	50m radius, 100m by 100m	5-6	25-30	11	SW	None	0	None	
Adelaide Wind Farm	7	Sub set	17	8	2015	9:30	10:00	30	1	Ken Edwards	4	6629	No	Circular	50m radius, 100m by 100m	5-6	25-30	11	SW	None	0	None	
Adelaide Wind Farm	11	Sub set	17	8	2015	10:05	10:35	30	1	Ken Edwards	4	2436	No	Circular	50m radius, 100m by 100m	5-6	25-30	11	SW	None	0	None	
Adelaide Wind Farm	14	Sub set	17	8	2015	10:50	11:20	30	1	Ken Edwards	4	3925	No	Circular	50m radius, 100m by 100m	5-6	25-30	11	SW	None	0	None	
Adelaide Wind Farm	17	Sub set	17	8	2015	11:30	12:20	50	1	Ken Edwards	4	7854	No	Circular	50m radius, 100m by 100m	5-6	25-30	11	SW	None	0	None	
Adelaide Wind Farm	19	Sub set	17	8	2015	12:40	13:10	30	1	Ken Edwards	4	6411	No	Circular	50m radius, 100m by 100m	5-6	25-30	11	SW	None	0	None	

**Table F1: Weekly Mortality Monitoring Survey Record**

Project Name	Turbine Number	Treatment Group	Day	Month	Year	Start Time	End Time	Duration Min	Number Of Searchers	Searchers' Names	Days Since Last Search	Actual Area Searched M2	Dog Used	Search Area Shape	Search Area Dimension	Transect Separation M	Temp Celsius	Wind Speed	Wind Direction	Precipitation	Cloud Cover Percentage	Significant Weather	Comments
Adelaide Wind Farm	20	Sub set	17	8	2015	13:20	13:50	30	1	Ken Edwards	4	7854	No	Circular	50m radius, 100m by 100m	5-6	25-30	11	SW	None	0	None	
Adelaide Wind Farm	22	Sub set	17	8	2015	14:00	14:30	30	1	Ken Edwards	4	5267	No	Circular	50m radius, 100m by 100m	5-6	25-30	11	SW	None	0	None	
Adelaide Wind Farm	27	Sub set	17	8	2015	14:40	15:10	30	1	Ken Edwards	4	7432	No	Circular	50m radius, 100m by 100m	5-6	25-30	11	SW	None	0	None	
Adelaide Wind Farm	6	Sub set	20	8	2015	8:35	9:10	35	1	Ken Edwards	3	6524	No	Circular	50m radius, 100m by 100m	5-6	19	14	W	Light Rain	100	Rain	
Adelaide Wind Farm	7	Sub set	20	8	2015	9:20	9:50	30	1	Ken Edwards	3	6629	No	Circular	50m radius, 100m by 100m	5-6	19	14	W	Light Rain	100	Rain	
Adelaide Wind Farm	11	Sub set	20	8	2015	10:00	10:35	35	1	Ken Edwards	3	2436	No	Circular	50m radius, 100m by 100m	5-6	19	14	W	Light Rain	100	Rain	
Adelaide Wind Farm	12	Sub set	20	8	2015	10:40	11:15	35	1	Ken Edwards	7	6895	No	Circular	50m radius, 100m by 100m	5-6	19	14	W	Light Rain	100	Rain	
Adelaide Wind Farm	14	Sub set	20	8	2015	11:20	11:50	30	1	Ken Edwards	3	3925	No	Circular	50m radius, 100m by 100m	5-6	19	14	W	Light Rain	100	Rain	
Adelaide Wind Farm	17	Sub set	20	8	2015	12:00	12:35	35	1	Ken Edwards	3	7854	No	Circular	50m radius, 100m by 100m	5-6	19	14	W	Light Rain	100	Rain	
Adelaide Wind Farm	20	Sub set	20	8	2015	12:55	13:35	40	1	Ken Edwards	3	7854	No	Circular	50m radius, 100m by 100m	5-6	19	14	W	Light Rain	100	Rain	
Adelaide Wind Farm	22	Sub set	20	8	2015	13:45	14:15	30	1	Ken Edwards	3	5267	No	Circular	50m radius, 100m by 100m	5-6	19	14	W	Light Rain	100	Rain	
Adelaide Wind Farm	27	Sub set	20	8	2015	14:25	15:00	35	1	Ken Edwards	3	7432	No	Circular	50m radius, 100m by 100m	5-6	19	14	W	Light Rain	100	Rain	

**Table F1: Weekly Mortality Monitoring Survey Record**

Project Name	Turbine Number	Treatment Group	Day	Month	Year	Start Time	End Time	Duration Min	Number Of Searchers	Searchers' Names	Days Since Last Search	Actual Area Searched M2	Dog Used	Search Area Shape	Search Area Dimension	Transect Separation M	Temp Celsius	Wind Speed	Wind Direction	Precipitation	Cloud Cover Percentage	Significant Weather	Comments
Adelaide Wind Farm	6	Sub set	24	8	2015	8:35	9:15	40	1	Ken Edwards	4	6524	No	Circular	50m radius, 100m by 100m	5-6	15	11	W	None	0	Light Rain	
Adelaide Wind Farm	7	Sub set	24	8	2015	9:25	10:15	50	1	Ken Edwards	4	7173	No	Circular	50m radius, 100m by 100m	5-6	15	11	W	None	0	Light Rain	
Adelaide Wind Farm	11	Sub set	24	8	2015	10:25	11:05	40	1	Ken Edwards	4	2436	No	Circular	50m radius, 100m by 100m	5-6	15	11	W	None	0	Light Rain	
Adelaide Wind Farm	12	Sub set	24	8	2015	11:15	11:50	35	1	Ken Edwards	4	6895	No	Circular	50m radius, 100m by 100m	5-6	15	11	W	None	0	Light Rain	
Adelaide Wind Farm	14	Sub set	24	8	2015	12:00	12:30	30	1	Ken Edwards	4	3925	No	Circular	50m radius, 100m by 100m	5-6	15	11	W	None	0	Light Rain	
Adelaide Wind Farm	17	Sub set	24	8	2015	13:00	13:55	55	1	Ken Edwards	4	7854	No	Circular	50m radius, 100m by 100m	5-6	15	11	W	None	0	Light Rain	
Adelaide Wind Farm	19	Sub set	24	8	2015	14:05	15:05	60	1	Ken Edwards	7	7854	No	Circular	50m radius, 100m by 100m	5-6	15	11	W	None	0	Light Rain	
Adelaide Wind Farm	22	Sub set	24	8	2015	15:15	15:50	35	1	Ken Edwards	4	5267	No	Circular	50m radius, 100m by 100m	5-6	15	11	W	None	0	Light Rain	
Adelaide Wind Farm	27	Sub set	24	8	2015	16:00	16:30	30	1	Ken Edwards	4	7432	No	Circular	50m radius, 100m by 100m	5-6	15	11	W	None	0	Light Rain	
Adelaide Wind Farm	6	Sub set	27	8	2015	8:35	9:10	35	1	Ken Edwards	3	6524	No	Circular	50m radius, 100m by 100m	5-6	14	6	W	None	90	Light Rain	
Adelaide Wind Farm	11	Sub set	27	8	2015	9:25	10:10	45	1	Ken Edwards	3	2436	No	Circular	50m radius, 100m by 100m	5-6	14	6	W	None	90	Light Rain	
Adelaide Wind Farm	12	Sub set	27	8	2015	10:15	10:45	30	1	Ken Edwards	3	6895	No	Circular	50m radius, 100m by 100m	5-6	14	6	W	None	90	Light Rain	

**Table F1: Weekly Mortality Monitoring Survey Record**

Project Name	Turbine Number	Treatment Group	Day	Month	Year	Start Time	End Time	Duration Min	Number Of Searchers	Searchers' Names	Days Since Last Search	Actual Area Searched M2	Dog Used	Search Area Shape	Search Area Dimension	Transect Separation M	Temp Celsius	Wind Speed	Wind Direction	Precipitation	Cloud Cover Percentage	Significant Weather	Comments
Adelaide Wind Farm	14	Sub set	27	8	2015	10:55	11:40	45	1	Ken Edwards	3	3925	No	Circular	50m radius, 100m by 100m	5-6	14	6	W	None	90	Light Rain	
Adelaide Wind Farm	17	Sub set	27	8	2015	11:50	12:20	30	1	Ken Edwards	3	7854	No	Circular	50m radius, 100m by 100m	5-6	14	6	W	None	90	Light Rain	
Adelaide Wind Farm	19	Sub set	27	8	2015	12:35	13:05	30	1	Ken Edwards	3	7854	No	Circular	50m radius, 100m by 100m	5-6	14	6	W	None	90	Light Rain	
Adelaide Wind Farm	20	Sub set	27	8	2015	13:15	13:50	35	1	Ken Edwards	7	5267	No	Circular	50m radius, 100m by 100m	5-6	14	6	W	None	90	Light Rain	
Adelaide Wind Farm	22	Sub set	27	8	2015	14:00	14:35	35	1	Ken Edwards	3	7432	No	Circular	50m radius, 100m by 100m	5-6	14	6	W	None	90	Light Rain	
Adelaide Wind Farm	7	Sub set	27	8	2015	14:55	15:40	45	1	Ken Edwards	3	7173	No	Circular	50m radius, 100m by 100m	5-6	14	6	W	None	90	Light Rain	
Adelaide Wind Farm	6	Sub set	31	8	2015	8:40	9:20	40	1	Ken Edwards	4	6524	No	Circular	50m radius, 100m by 100m	5-6	20	3	SW	None	60	None	
Adelaide Wind Farm	7	Sub set	31	8	2015	9:35	10:10	35	1	Ken Edwards	4	7173	No	Circular	50m radius, 100m by 100m	5-6	20	3	SW	None	60	None	
Adelaide Wind Farm	11	Sub set	31	8	2015	10:20	10:50	30	1	Ken Edwards	4	2436	No	Circular	50m radius, 100m by 100m	5-6	20	3	SW	None	60	None	
Adelaide Wind Farm	12	Sub set	31	8	2015	11:00	12:00	60	1	Ken Edwards	4	6895	No	Circular	50m radius, 100m by 100m	5-6	20	3	SW	None	60	None	
Adelaide Wind Farm	14	Sub set	31	8	2015	12:10	12:45	35	1	Ken Edwards	4	3925	No	Circular	50m radius, 100m by 100m	5-6	20	3	SW	None	60	None	
Adelaide Wind Farm	17	Sub set	31	8	2015	13:10	13:50	40	1	Ken Edwards	4	7854	No	Circular	50m radius, 100m by 100m	5-6	20	3	SW	None	60	None	

**Table F1: Weekly Mortality Monitoring Survey Record**

Project Name	Turbine Number	Treatment Group	Day	Month	Year	Start Time	End Time	Duration Min	Number Of Searchers	Searchers' Names	Days Since Last Search	Actual Area Searched M2	Dog Used	Search Area Shape	Search Area Dimension	Transect Separation M	Temp Celsius	Wind Speed	Wind Direction	Precipitation	Cloud Cover Percentage	Significant Weather	Comments
Adelaide Wind Farm	19	Sub set	31	8	2015	14:00	14:40	40	1	Ken Edwards	4	7854	No	Circular	50m radius, 100m by 100m	5-6	20	3	SW	None	60	None	
Adelaide Wind Farm	20	Sub set	31	8	2015	14:50	15:25	35	1	Ken Edwards	4	7854	No	Circular	50m radius, 100m by 100m	5-6	20	3	SW	None	60	None	
Adelaide Wind Farm	22	Sub set	31	8	2015	15:35	16:05	30	1	Ken Edwards	4	5267	No	Circular	50m radius, 100m by 100m	5-6	20	3	SW	None	60	None	
Adelaide Wind Farm	27	Sub set	31	8	2015	16:15	16:45	30	1	Ken Edwards	7	7432	No	Circular	50m radius, 100m by 100m	5-6	20	3	SW	None	60	None	
Adelaide Wind Farm	6	Sub set	3	9	2015	8:40	10:10	90	1	Ken Edwards	3	6524	No	Circular	50m radius, 100m by 100m	5-6	25-30	3	W	None	100	None	
Adelaide Wind Farm	11	Sub set	3	9	2015	10:25	11:05	40	1	Ken Edwards	3	2436	No	Circular	50m radius, 100m by 100m	5-6	25-30	3	W	None	100	None	
Adelaide Wind Farm	12	Sub set	3	9	2015	11:15	12:00	45	1	Ken Edwards	3	6895	No	Circular	50m radius, 100m by 100m	5-6	25-30	3	W	None	100	None	
Adelaide Wind Farm	14	Sub set	3	9	2015	12:20	12:50	30	1	Ken Edwards	3	3925	No	Circular	50m radius, 100m by 100m	5-6	25-30	3	W	None	100	None	
Adelaide Wind Farm	17	Sub set	3	9	2015	13:05	14:25	80	1	Ken Edwards	3	7854	No	Circular	50m radius, 100m by 100m	5-6	25-30	3	W	None	100	None	
Adelaide Wind Farm	19	Sub set	3	9	2015	14:35	15:10	35	1	Ken Edwards	3	7854	No	Circular	50m radius, 100m by 100m	5-6	25-30	3	W	None	100	None	
Adelaide Wind Farm	6	Sub set	7	9	2015	8:35	9:20	45	1	Ken Edwards	4	6524	No	Circular	50m radius, 100m by 100m	5-6	26-31	13	SW	None	10	None	
Adelaide Wind Farm	7	Sub set	7	9	2015	9:30	10:00	30	1	Ken Edwards	7	7173	No	Circular	50m radius, 100m by 100m	5-6	26-31	13	SW	None	10	None	



**Table F1: Weekly Mortality Monitoring Survey Record**

Project Name	Turbine Number	Treatment Group	Day	Month	Year	Start Time	End Time	Duration Min	Number Of Searchers	Searchers' Names	Days Since Last Search	Actual Area Searched M2	Dog Used	Search Area Shape	Search Area Dimension	Transect Separation M	Temp Celsius	Wind Speed	Wind Direction	Precipitation	Cloud Cover Percentage	Significant Weather	Comments
Adelaide Wind Farm	11	Sub set	7	9	2015	10:20	10:50	30	1	Ken Edwards	4	2436	No	Circular	50m radius, 100m by 100m	5-6	26-31	13	SW	None	10	None	
Adelaide Wind Farm	12	Sub set	7	9	2015	11:00	11:35	35	1	Ken Edwards	4	6895	No	Circular	50m radius, 100m by 100m	5-6	26-31	13	SW	None	10	None	
Adelaide Wind Farm	14	Sub set	7	9	2015	11:40	12:10	30	1	Ken Edwards	4	3925	No	Circular	50m radius, 100m by 100m	5-6	26-31	13	SW	None	10	None	
Adelaide Wind Farm	17	Sub set	7	9	2015	12:20	12:50	30	1	Ken Edwards	4	7854	No	Circular	50m radius, 100m by 100m	5-6	26-31	13	SW	None	10	None	
Adelaide Wind Farm	19	Sub set	7	9	2015	12:55	13:25	30	1	Ken Edwards	4	7854	No	Circular	50m radius, 100m by 100m	5-6	26-31	13	SW	None	10	None	
Adelaide Wind Farm	20	Sub set	7	9	2015	13:40	14:10	30	1	Ken Edwards	7	7854	No	Circular	50m radius, 100m by 100m	5-6	26-31	13	SW	None	10	None	
Adelaide Wind Farm	22	Sub set	7	9	2015	14:25	14:55	30	1	Ken Edwards	7	5267	No	Circular	50m radius, 100m by 100m	5-6	26-31	13	SW	None	10	None	
Adelaide Wind Farm	27	Sub set	7	9	2015	15:00	15:30	30	1	Ken Edwards	7	7432	No	Circular	50m radius, 100m by 100m	5-6	26-31	13	SW	None	10	None	
Adelaide Wind Farm	6	Sub set	10	9	2015	8:30	9:00	30	1	Ken Edwards	3	6524	No	Circular	50m radius, 100m by 100m	5-6	19-25	6	NE	None	10	Light Rain	
Adelaide Wind Farm	7	Sub set	10	9	2015	9:15	9:45	30	1	Ken Edwards	3	7173	No	Circular	50m radius, 100m by 100m	5-6	19-25	6	NE	None	10	Light Rain	
Adelaide Wind Farm	11	Sub set	10	9	2015	9:50	10:20	30	1	Ken Edwards	3	2436	No	Circular	50m radius, 100m by 100m	5-6	19-25	6	NE	None	10	Light Rain	
Adelaide Wind Farm	12	Sub set	10	9	2015	10:25	11:05	40	1	Ken Edwards	3	6895	No	Circular	50m radius, 100m by 100m	5-6	19-25	6	NE	None	10	Light Rain	

**Table F1: Weekly Mortality Monitoring Survey Record**

Project Name	Turbine Number	Treatment Group	Day	Month	Year	Start Time	End Time	Duration Min	Number Of Searchers	Searchers' Names	Days Since Last Search	Actual Area Searched M2	Dog Used	Search Area Shape	Search Area Dimension	Transect Separation M	Temp Celsius	Wind Speed	Wind Direction	Precipitation	Cloud Cover Percentage	Significant Weather	Comments
Adelaide Wind Farm	14	Sub set	10	9	2015	11:15	11:55	40	1	Ken Edwards	3	3925	No	Circular	50m radius, 100m by 100m	5-6	19-25	6	NE	None	10	Light Rain	
Adelaide Wind Farm	17	Sub set	10	9	2015	12:00	12:30	30	1	Ken Edwards	3	7854	No	Circular	50m radius, 100m by 100m	5-6	19-25	6	NE	None	10	Light Rain	
Adelaide Wind Farm	19	Sub set	10	9	2015	12:35	13:05	30	1	Ken Edwards	3	7854	No	Circular	50m radius, 100m by 100m	5-6	19-25	6	NE	None	10	Light Rain	
Adelaide Wind Farm	20	Sub set	10	9	2015	13:20	13:50	30	1	Ken Edwards	3	7854	No	Circular	50m radius, 100m by 100m	5-6	19-25	6	NE	None	10	Light Rain	
Adelaide Wind Farm	27	Sub set	10	9	2015	14:00	14:30	30	1	Ken Edwards	3	7432	No	Circular	50m radius, 100m by 100m	5-6	19-25	6	NE	None	10	Light Rain	
Adelaide Wind Farm	6	Sub set	14	9	2015	8:35	9:05	30	1	Ken Edwards	4	2745	No	Circular	50m radius, 100m by 100m	5-6	13-22	6	SW	None	0	None	
Adelaide Wind Farm	7	Sub set	14	9	2015	9:30	10:00	30	1	Ken Edwards	4	7173	No	Circular	50m radius, 100m by 100m	5-6	13-22	6	SW	None	0	None	
Adelaide Wind Farm	11	Sub set	14	9	2015	10:10	10:45	35	1	Ken Edwards	4	2436	No	Circular	50m radius, 100m by 100m	5-6	13-22	6	SW	None	0	None	
Adelaide Wind Farm	12	Sub set	14	9	2015	10:50	11:20	30	1	Ken Edwards	4	6895	No	Circular	50m radius, 100m by 100m	5-6	13-22	6	SW	None	0	None	
Adelaide Wind Farm	14	Sub set	14	9	2015	11:25	11:55	30	1	Ken Edwards	4	3925	No	Circular	50m radius, 100m by 100m	5-6	13-22	6	SW	None	0	None	
Adelaide Wind Farm	17	Sub set	14	9	2015	12:25	12:55	30	1	Ken Edwards	4	7854	No	Circular	50m radius, 100m by 100m	5-6	13-22	6	SW	None	0	None	
Adelaide Wind Farm	19	Sub set	14	9	2015	13:05	13:35	30	1	Ken Edwards	4	7854	No	Circular	50m radius, 100m by 100m	5-6	13-22	6	SW	None	0	None	

**Table F1: Weekly Mortality Monitoring Survey Record**

Project Name	Turbine Number	Treatment Group	Day	Month	Year	Start Time	End Time	Duration Min	Number Of Searchers	Searchers' Names	Days Since Last Search	Actual Area Searched M2	Dog Used	Search Area Shape	Search Area Dimension	Transect Separation M	Temp Celsius	Wind Speed	Wind Direction	Precipitation	Cloud Cover Percentage	Significant Weather	Comments
Adelaide Wind Farm	20	Sub set	14	9	2015	13:45	14:15	30	1	Ken Edwards	4	7854	No	Circular	50m radius, 100m by 100m	5-6	13-22	6	SW	None	0	None	
Adelaide Wind Farm	22	Sub set	14	9	2015	14:25	14:55	30	1	Ken Edwards	7	5267	No	Circular	50m radius, 100m by 100m	5-6	13-22	6	SW	None	0	None	
Adelaide Wind Farm	27	Sub set	14	9	2015	15:00	15:45	45	1	Ken Edwards	4	7432	No	Circular	50m radius, 100m by 100m	5-6	13-22	6	SW	None	0	None	
Adelaide Wind Farm	6	Sub set	17	9	2015	8:35	9:10	35	1	Ken Edwards	3	2745	No	Circular	50m radius, 100m by 100m	5-6	15-27	3	SE	None	0	None	
Adelaide Wind Farm	7	Sub set	17	9	2015	9:20	10:00	40	1	Ken Edwards	3	7173	No	Circular	50m radius, 100m by 100m	5-6	15-27	3	SE	None	0	None	
Adelaide Wind Farm	11	Sub set	17	9	2015	10:10	10:40	30	1	Ken Edwards	3	2436	No	Circular	50m radius, 100m by 100m	5-6	15-27	3	SE	None	0	None	
Adelaide Wind Farm	12	Sub set	17	9	2015	10:55	11:30	35	1	Ken Edwards	3	6895	No	Circular	50m radius, 100m by 100m	5-6	15-27	3	SE	None	0	None	
Adelaide Wind Farm	14	Sub set	17	9	2015	11:50	12:25	35	1	Ken Edwards	3	3925	No	Circular	50m radius, 100m by 100m	5-6	15-27	3	SE	None	0	None	
Adelaide Wind Farm	17	Sub set	17	9	2015	12:55	13:40	45	1	Ken Edwards	3	7854	No	Circular	50m radius, 100m by 100m	5-6	15-27	3	SE	None	0	None	
Adelaide Wind Farm	19	Sub set	17	9	2015	13:45	14:15	30	1	Ken Edwards	3	7854	No	Circular	50m radius, 100m by 100m	5-6	15-27	3	SE	None	0	None	
Adelaide Wind Farm	20	Sub set	17	9	2015	14:15	14:45	30	1	Ken Edwards	3	7854	No	Circular	50m radius, 100m by 100m	5-6	15-27	3	SE	None	0	None	
Adelaide Wind Farm	22	Sub set	17	9	2015	14:50	15:20	30	1	Ken Edwards	3	5267	No	Circular	50m radius, 100m by 100m	5-6	15-27	3	SE	None	0	None	

**Table F1: Weekly Mortality Monitoring Survey Record**

Project Name	Turbine Number	Treatment Group	Day	Month	Year	Start Time	End Time	Duration Min	Number Of Searchers	Searchers' Names	Days Since Last Search	Actual Area Searched M2	Dog Used	Search Area Shape	Search Area Dimension	Transect Separation M	Temp Celsius	Wind Speed	Wind Direction	Precipitation	Cloud Cover Percentage	Significant Weather	Comments
Adelaide Wind Farm	27	Sub set	17	9	2015	15:25	15:55	30	1	Ken Edwards	3	7432	No	Circular	50m radius, 100m by 100m	5-6	15-27	3	SE	None	0	None	
Adelaide Wind Farm	6	Sub set	21	9	2015	8:30	9:00	30	1	Ken Edwards	4	2745	No	Circular	50m radius, 100m by 100m	5-6	17	14	E	None	0	None	
Adelaide Wind Farm	7	Sub set	21	9	2015	9:05	9:45	40	1	Ken Edwards	4	7173	No	Circular	50m radius, 100m by 100m	5-6	17	14	E	None	0	None	
Adelaide Wind Farm	12	Sub set	21	9	2015	9:55	10:35	40	1	Ken Edwards	4	6895	No	Circular	50m radius, 100m by 100m	5-6	17	14	E	None	0	None	
Adelaide Wind Farm	14	Sub set	21	9	2015	10:50	11:30	40	1	Ken Edwards	4	3925	No	Circular	50m radius, 100m by 100m	5-6	17	14	E	None	0	None	
Adelaide Wind Farm	17	Sub set	21	9	2015	11:40	12:10	30	1	Ken Edwards	4	7854	No	Circular	50m radius, 100m by 100m	5-6	17	14	E	None	0	None	
Adelaide Wind Farm	19	Sub set	21	9	2015	12:35	13:15	40	1	Ken Edwards	4	7854	No	Circular	50m radius, 100m by 100m	5-6	17	14	E	None	0	None	
Adelaide Wind Farm	20	Sub set	21	9	2015	13:25	13:55	30	1	Ken Edwards	4	7854	No	Circular	50m radius, 100m by 100m	5-6	17	14	E	None	0	None	
Adelaide Wind Farm	22	Sub set	21	9	2015	14:05	14:35	30	1	Ken Edwards	4	5267	No	Circular	50m radius, 100m by 100m	5-6	17	14	E	None	0	None	
Adelaide Wind Farm	27	Sub set	21	9	2015	14:35	15:05	30	1	Ken Edwards	4	7432	No	Circular	50m radius, 100m by 100m	5-6	17	14	E	None	0	None	
Adelaide Wind Farm	11	Sub set	21	9	2015	15:20	15:50	30	1	Ken Edwards	4	2436	No	Circular	50m radius, 100m by 100m	5-6	17	14	E	None	0	None	
Adelaide Wind Farm	6	Sub set	24	9	2015	8:50	9:20	30	1	Ken Edwards	3	2745	No	Circular	50m radius, 100m by 100m	5-6	18-24	11	E	None	0	None	

**Table F1: Weekly Mortality Monitoring Survey Record**

Project Name	Turbine Number	Treatment Group	Day	Month	Year	Start Time	End Time	Duration Min	Number Of Searchers	Searchers' Names	Days Since Last Search	Actual Area Searched M2	Dog Used	Search Area Shape	Search Area Dimension	Transect Separation M	Temp Celsius	Wind Speed	Wind Direction	Precipitation	Cloud Cover Percentage	Significant Weather	Comments
Adelaide Wind Farm	7	Sub set	24	9	2015	9:30	10:00	30	1	Ken Edwards	3	7173	No	Circular	50m radius, 100m by 100m	5-6	18-24	11	E	None	0	None	
Adelaide Wind Farm	11	Sub set	24	9	2015	10:05	10:35	30	1	Ken Edwards	3	2436	No	Circular	50m radius, 100m by 100m	5-6	18-24	11	E	None	0	None	
Adelaide Wind Farm	14	Sub set	24	9	2015	10:50	11:20	30	1	Ken Edwards	3	3925	No	Circular	50m radius, 100m by 100m	5-6	18-24	11	E	None	0	None	
Adelaide Wind Farm	17	Sub set	24	9	2015	11:45	12:20	35	1	Ken Edwards	3	7854	No	Circular	50m radius, 100m by 100m	5-6	18-24	11	E	None	0	None	
Adelaide Wind Farm	19	Sub set	24	9	2015	12:30	13:00	30	1	Ken Edwards	3	7854	No	Circular	50m radius, 100m by 100m	5-6	18-24	11	E	None	0	None	
Adelaide Wind Farm	22	Sub set	24	9	2015	13:10	13:40	30	1	Ken Edwards	3	5267	No	Circular	50m radius, 100m by 100m	5-6	18-24	11	E	None	0	None	
Adelaide Wind Farm	27	Sub set	24	9	2015	13:50	14:30	40	1	Ken Edwards	3	7432	No	Circular	50m radius, 100m by 100m	5-6	18-24	11	E	None	0	None	
Adelaide Wind Farm	20	Sub set	24	9	2015	14:40	15:10	30	1	Ken Edwards	3	7854	No	Circular	50m radius, 100m by 100m	5-6	18-24	11	E	None	0	None	
Adelaide Wind Farm	12	Sub set	24	9	2015	15:20	15:50	30	1	Ken Edwards	3	6895	No	Circular	50m radius, 100m by 100m	5-6	18-24	11	E	None	0	None	
Adelaide Wind Farm	7	Sub set	28	9	2015	8:35	9:15	40	1	Ken Edwards	4	7173	No	Circular	50m radius, 100m by 100m	5-6	22-24	14	SW	None	100	None	
Adelaide Wind Farm	6	Sub set	28	9	2015	9:25	10:05	40	1	Ken Edwards	4	6175	No	Circular	50m radius, 100m by 100m	5-6	22-24	14	SW	None	100	None	
Adelaide Wind Farm	11	Sub set	28	9	2015	10:15	10:55	40	1	Ken Edwards	4	2436	No	Circular	50m radius, 100m by 100m	5-6	22-24	14	SW	None	100	None	

**Table F1: Weekly Mortality Monitoring Survey Record**

Project Name	Turbine Number	Treatment Group	Day	Month	Year	Start Time	End Time	Duration Min	Number Of Searchers	Searchers' Names	Days Since Last Search	Actual Area Searched M2	Dog Used	Search Area Shape	Search Area Dimension	Transect Separation M	Temp Celsius	Wind Speed	Wind Direction	Precipitation	Cloud Cover Percentage	Significant Weather	Comments
Adelaide Wind Farm	12	Sub set	28	9	2015	11:15	11:55	40	1	Ken Edwards	4	7854	No	Circular	50m radius, 100m by 100m	5-6	22-24	14	SW	None	100	None	
Adelaide Wind Farm	14	Sub set	28	9	2015	12:25	13:00	35	1	Ken Edwards	4	3925	No	Circular	50m radius, 100m by 100m	5-6	22-24	14	SW	None	100	None	
Adelaide Wind Farm	17	Sub set	28	9	2015	13:10	13:50	40	1	Ken Edwards	4	7854	No	Circular	50m radius, 100m by 100m	5-6	22-24	14	SW	None	100	None	
Adelaide Wind Farm	19	Sub set	28	9	2015	13:55	14:30	35	1	Ken Edwards	4	7854	No	Circular	50m radius, 100m by 100m	5-6	22-24	14	SW	None	100	None	
Adelaide Wind Farm	20	Sub set	28	9	2015	14:40	15:10	30	1	Ken Edwards	4	7854	No	Circular	50m radius, 100m by 100m	5-6	22-24	14	SW	None	100	None	
Adelaide Wind Farm	22	Sub set	28	9	2015	15:15	15:45	30	1	Ken Edwards	4	5267	No	Circular	50m radius, 100m by 100m	5-6	22-24	14	SW	None	100	None	
Adelaide Wind Farm	27	Sub set	28	9	2015	15:55	16:25	30	1	Ken Edwards	4	7854	No	Circular	50m radius, 100m by 100m	5-6	22-24	14	SW	None	100	None	
Adelaide Wind Farm	6	Sub set	1	10	2015	8:40	9:20	40	1	Ken Edwards	3	2745	No	Circular	50m radius, 100m by 100m	5-6	8-15	16	NE	None	20	None	
Adelaide Wind Farm	7	Sub set	1	10	2015	9:30	10:05	35	1	Ken Edwards	3	7173	No	Circular	50m radius, 100m by 100m	5-6	8-15	16	NE	None	20	None	
Adelaide Wind Farm	11	Sub set	1	10	2015	10:15	10:50	35	1	Ken Edwards	3	2436	No	Circular	50m radius, 100m by 100m	5-6	8-15	16	NE	None	20	None	
Adelaide Wind Farm	12	Sub set	1	10	2015	11:00	11:40	40	1	Ken Edwards	3	6895	No	Circular	50m radius, 100m by 100m	5-6	8-15	16	NE	None	20	None	
Adelaide Wind Farm	14	Sub set	1	10	2015	12:00	12:35	35	1	Ken Edwards	3	3925	No	Circular	50m radius, 100m by 100m	5-6	8-15	16	NE	None	20	None	

**Table F1: Weekly Mortality Monitoring Survey Record**

Project Name	Turbine Number	Treatment Group	Day	Month	Year	Start Time	End Time	Duration Min	Number Of Searchers	Searchers' Names	Days Since Last Search	Actual Area Searched M2	Dog Used	Search Area Shape	Search Area Dimension	Transect Separation M	Temp Celsius	Wind Speed	Wind Direction	Precipitation	Cloud Cover Percentage	Significant Weather	Comments
Adelaide Wind Farm	17	Sub set	1	10	2015	12:45	13:20	35	1	Ken Edwards	3	7854	No	Circular	50m radius, 100m by 100m	5-6	8-15	16	NE	None	20	None	
Adelaide Wind Farm	19	Sub set	1	10	2015	13:30	14:00	30	1	Ken Edwards	3	7854	No	Circular	50m radius, 100m by 100m	5-6	8-15	16	NE	None	20	None	
Adelaide Wind Farm	20	Sub set	1	10	2015	14:10	14:40	30	1	Ken Edwards	3	7854	No	Circular	50m radius, 100m by 100m	5-6	8-15	16	NE	None	20	None	
Adelaide Wind Farm	22	Sub set	1	10	2015	15:05	15:40	35	1	Ken Edwards	3	5267	No	Circular	50m radius, 100m by 100m	5-6	8-15	16	NE	None	20	None	
Adelaide Wind Farm	27	Sub set	1	10	2015	15:50	16:30	40	1	Ken Edwards	3	7854	No	Circular	50m radius, 100m by 100m	5-6	8-15	16	NE	None	20	None	
Adelaide Wind Farm	7	Sub set	5	10	2015	8:35	9:15	40	1	Ken Edwards	4	7173	No	Circular	50m radius, 100m by 100m	5-6	12	6	NE	Light Rain	60	Rain	
Adelaide Wind Farm	6	Sub set	5	10	2015	9:25	10:00	35	1	Ken Edwards	4	7854	No	Circular	50m radius, 100m by 100m	5-6	12	6	NE	Light Rain	60	Rain	
Adelaide Wind Farm	11	Sub set	5	10	2015	10:15	10:50	35	1	Ken Edwards	4	7854	No	Circular	50m radius, 100m by 100m	5-6	12	6	NE	Light Rain	60	Rain	
Adelaide Wind Farm	12	Sub set	5	10	2015	11:00	11:30	30	1	Ken Edwards	4	7854	No	Circular	50m radius, 100m by 100m	5-6	12	6	NE	Light Rain	60	Rain	
Adelaide Wind Farm	14	Sub set	5	10	2015	11:35	12:05	30	1	Ken Edwards	4	3925	No	Circular	50m radius, 100m by 100m	5-6	12	6	NE	Light Rain	60	Rain	
Adelaide Wind Farm	17	Sub set	5	10	2015	12:35	13:15	40	1	Ken Edwards	4	7854	No	Circular	50m radius, 100m by 100m	5-6	12	6	NE	Light Rain	60	Rain	
Adelaide Wind Farm	19	Sub set	5	10	2015	13:25	13:55	30	1	Ken Edwards	4	7854	No	Circular	50m radius, 100m by 100m	5-6	12	6	NE	Light Rain	60	Rain	

**Table F1: Weekly Mortality Monitoring Survey Record**

Project Name	Turbine Number	Treatment Group	Day	Month	Year	Start Time	End Time	Duration Min	Number Of Searchers	Searchers' Names	Days Since Last Search	Actual Area Searched M2	Dog Used	Search Area Shape	Search Area Dimension	Transect Separation M	Temp Celsius	Wind Speed	Wind Direction	Precipitation	Cloud Cover Percentage	Significant Weather	Comments
Adelaide Wind Farm	20	Sub set	5	10	2015	14:05	14:40	35	1	Ken Edwards	4	7854	No	Circular	50m radius, 100m by 100m	5-6	12	6	NE	Light Rain	60	Rain	
Adelaide Wind Farm	22	Sub set	5	10	2015	14:50	15:25	35	1	Ken Edwards	4	5267	No	Circular	50m radius, 100m by 100m	5-6	12	6	NE	Light Rain	60	Rain	
Adelaide Wind Farm	27	Sub set	5	10	2015	15:35	16:15	40	1	Ken Edwards	4	7854	No	Circular	50m radius, 100m by 100m	5-6	12	6	NE	Light Rain	60	Rain	
Adelaide Wind Farm	7	Sub set	8	10	2015	8:45	9:15	30	1	Ken Edwards	3	7173	No	Circular	50m radius, 100m by 100m	5-6	14	8	SE	None	30	None	
Adelaide Wind Farm	6	Sub set	8	10	2015	9:20	9:50	30	1	Ken Edwards	3	7854	No	Circular	50m radius, 100m by 100m	5-6	14	8	SE	None	30	None	
Adelaide Wind Farm	11	Sub set	8	10	2015	10:00	10:35	35	1	Ken Edwards	3	7854	No	Circular	50m radius, 100m by 100m	5-6	14	8	SE	None	30	None	
Adelaide Wind Farm	12	Sub set	8	10	2015	10:45	11:30	45	1	Ken Edwards	3	7854	No	Circular	50m radius, 100m by 100m	5-6	14	8	SE	None	30	None	
Adelaide Wind Farm	14	Sub set	8	10	2015	11:35	12:10	35	1	Ken Edwards	3	3925	No	Circular	50m radius, 100m by 100m	5-6	14	8	SE	None	30	None	
Adelaide Wind Farm	17	Sub set	8	10	2015	12:35	13:15	40	1	Ken Edwards	3	7854	No	Circular	50m radius, 100m by 100m	5-6	14	8	SE	None	30	None	
Adelaide Wind Farm	19	Sub set	8	10	2015	13:20	13:55	35	1	Ken Edwards	3	7854	No	Circular	50m radius, 100m by 100m	5-6	14	8	SE	None	30	None	
Adelaide Wind Farm	20	Sub set	8	10	2015	14:10	14:50	40	1	Ken Edwards	3	7854	No	Circular	50m radius, 100m by 100m	5-6	14	8	SE	None	30	None	
Adelaide Wind Farm	22	Sub set	8	10	2015	15:10	15:50	40	1	Ken Edwards	3	5267	No	Circular	50m radius, 100m by 100m	5-6	14	8	SE	None	30	None	



**Table F1: Weekly Mortality Monitoring Survey Record**

Project Name	Turbine Number	Treatment Group	Day	Month	Year	Start Time	End Time	Duration Min	Number Of Searchers	Searchers' Names	Days Since Last Search	Actual Area Searched M2	Dog Used	Search Area Shape	Search Area Dimension	Transect Separation M	Temp Celsius	Wind Speed	Wind Direction	Precipitation	Cloud Cover Percentage	Significant Weather	Comments
Adelaide Wind Farm	27	Sub set	8	10	2015	16:00	16:30	30	1	Ken Edwards	3	7854	No	Circular	50m radius, 100m by 100m	5-6	14	8	SE	None	30	None	
Adelaide Wind Farm	7	Sub set	12	10	2015	8:40	9:15	35	1	Ken Edwards	4	7854	No	Circular	50m radius, 100m by 100m	5-6	18	23	S	None	0	None	
Adelaide Wind Farm	6	Sub set	12	10	2015	9:30	10:05	35	1	Ken Edwards	4	7854	No	Circular	50m radius, 100m by 100m	5-6	18	23	S	None	0	None	
Adelaide Wind Farm	11	Sub set	12	10	2015	10:15	10:55	40	1	Ken Edwards	4	7854	No	Circular	50m radius, 100m by 100m	5-6	18	23	S	None	0	None	
Adelaide Wind Farm	12	Sub set	12	10	2015	11:05	11:45	40	1	Ken Edwards	4	7854	No	Circular	50m radius, 100m by 100m	5-6	18	23	S	None	0	None	
Adelaide Wind Farm	14	Sub set	12	10	2015	12:10	12:45	35	1	Ken Edwards	4	4712	No	Circular	50m radius, 100m by 100m	5-6	18	23	S	None	0	None	
Adelaide Wind Farm	17	Sub set	12	10	2015	13:00	13:30	30	1	Ken Edwards	4	7854	No	Circular	50m radius, 100m by 100m	5-6	18	23	S	None	0	None	
Adelaide Wind Farm	19	Sub set	12	10	2015	13:40	14:10	30	1	Ken Edwards	4	7854	No	Circular	50m radius, 100m by 100m	5-6	18	23	S	None	0	None	
Adelaide Wind Farm	22	Sub set	12	10	2015	14:30	15:00	30	1	Ken Edwards	4	5267	No	Circular	50m radius, 100m by 100m	5-6	18	23	S	None	0	None	
Adelaide Wind Farm	27	Sub set	12	10	2015	15:10	15:50	40	1	Ken Edwards	4	7854	No	Circular	50m radius, 100m by 100m	5-6	18	23	S	None	0	None	
Adelaide Wind Farm	7	Sub set	15	10	2015	8:40	9:15	35	1	Ken Edwards	3	7854	No	Circular	50m radius, 100m by 100m	5-6	14	18	SW	None	20	None	
Adelaide Wind Farm	6	Sub set	15	10	2015	9:25	9:55	30	1	Ken Edwards	3	7854	No	Circular	50m radius, 100m by 100m	5-6	14	18	SW	None	20	None	

**Table F1: Weekly Mortality Monitoring Survey Record**

Project Name	Turbine Number	Treatment Group	Day	Month	Year	Start Time	End Time	Duration Min	Number Of Searchers	Searchers' Names	Days Since Last Search	Actual Area Searched M2	Dog Used	Search Area Shape	Search Area Dimension	Transect Separation M	Temp Celsius	Wind Speed	Wind Direction	Precipitation	Cloud Cover Percentage	Significant Weather	Comments
Adelaide Wind Farm	11	Sub set	15	10	2015	10:05	10:35	30	1	Ken Edwards	3	7854	No	Circular	50m radius, 100m by 100m	5-6	14	18	SW	None	20	None	
Adelaide Wind Farm	12	Sub set	15	10	2015	10:55	11:35	40	1	Ken Edwards	3	7854	No	Circular	50m radius, 100m by 100m	5-6	14	18	SW	None	20	None	
Adelaide Wind Farm	14	Sub set	15	10	2015	12:05	12:45	40	1	Ken Edwards	3	4712	No	Circular	50m radius, 100m by 100m	5-6	14	18	SW	None	20	None	
Adelaide Wind Farm	17	Sub set	15	10	2015	13:00	13:30	30	1	Ken Edwards	3	7854	No	Circular	50m radius, 100m by 100m	5-6	14	18	SW	None	20	None	
Adelaide Wind Farm	20	Sub set	15	10	2015	13:50	14:35	45	1	Ken Edwards	7	7854	No	Circular	50m radius, 100m by 100m	5-6	14	18	SW	None	20	None	
Adelaide Wind Farm	22	Sub set	15	10	2015	14:45	15:25	40	1	Ken Edwards	3	5267	No	Circular	50m radius, 100m by 100m	5-6	14	18	SW	None	20	None	
Adelaide Wind Farm	27	Sub set	15	10	2015	15:50	16:35	45	1	Ken Edwards	3	7854	No	Circular	50m radius, 100m by 100m	5-6	14	18	SW	None	20	None	
Adelaide Wind Farm	27	Sub set	19	10	2015	8:45	9:21	36	1	Anna Corrigan	4	7854	No	Circular	50m radius, 100m by 100m	5-6	2-14	22-38	SW	None	10-100	Snow	Difficult to survey turbine due to 5-10cm of snow in search.
Adelaide Wind Farm	22	Sub set	19	10	2015	9:40	10:11	31	1	Anna Corrigan	4	5267	No	Circular	50m radius, 100m by 100m	5-6	2-14	22-38	SW	None	10-100	Snow	Difficult to survey turbine due to 5-10cm of snow in search.
Adelaide Wind Farm	20	Sub set	19	10	2015	10:20	10:56	36	1	Anna Corrigan	4	7854	No	Circular	50m radius, 100m by 100m	5-6	2-14	22-38	SW	None	10-100	Snow	Difficult to survey turbine due to 5-10cm of snow in search.

**Table F1: Weekly Mortality Monitoring Survey Record**

Project Name	Turbine Number	Treatment Group	Day	Month	Year	Start Time	End Time	Duration Min	Number Of Searchers	Searchers' Names	Days Since Last Search	Actual Area Searched M2	Dog Used	Search Area Shape	Search Area Dimension	Transect Separation M	Temp Celsius	Wind Speed	Wind Direction	Precipitation	Cloud Cover Percentage	Significant Weather	Comments
Adelaide Wind Farm	19	Sub set	19	10	2015	11:08	11:44	36	1	Anna Corrigan	7	7854	No	Circular	50m radius, 100m by 100m	5-6	2-14	22-38	SW	None	10-100	Snow	Difficult to survey turbine due to 5-10cm of snow in search.
Adelaide Wind Farm	17	Sub set	19	10	2015	11:52	12:26	34	1	Anna Corrigan	4	7854	No	Circular	50m radius, 100m by 100m	5-6	2-14	22-38	SW	None	10-100	Snow	
Adelaide Wind Farm	14	Sub set	19	10	2015	12:34	13:04	30	1	Anna Corrigan	4	4712	No	Circular	50m radius, 100m by 100m	5-6	2-14	22-38	SW	None	10-100	Snow	
Adelaide Wind Farm	12	Sub set	19	10	2015	13:11	13:43	32	1	Anna Corrigan	4	7854	No	Circular	50m radius, 100m by 100m	5-6	2-14	22-38	SW	None	10-100	Snow	
Adelaide Wind Farm	6	Sub set	19	10	2015	13:52	14:23	31	1	Anna Corrigan	4	7854	No	Circular	50m radius, 100m by 100m	5-6	2-14	22-38	SW	None	10-100	Snow	
Adelaide Wind Farm	7	Sub set	19	10	2015	14:32	15:03	31	1	Anna Corrigan	4	7854	No	Circular	50m radius, 100m by 100m	5-6	2-14	22-38	SW	None	10-100	Snow	
Adelaide Wind Farm	27	Sub set	22	10	2015	8:20	8:51	31	1	Anna Corrigan	3	7854	No	Circular	50m radius, 100m by 100m	5-6	13-14	19-23	N W	None	10-90	None	
Adelaide Wind Farm	22	Sub set	22	10	2015	8:59	9:29	30	1	Anna Corrigan	3	5267	No	Circular	50m radius, 100m by 100m	5-6	13-14	19-23	N W	None	10-90	None	
Adelaide Wind Farm	19	Sub set	22	10	2015	9:41	10:12	31	1	Anna Corrigan	3	7854	No	Circular	50m radius, 100m by 100m	5-6	13-14	19-23	N W	None	10-90	None	
Adelaide Wind Farm	17	Sub set	22	10	2015	10:19	10:49	30	1	Anna Corrigan	3	7854	No	Circular	50m radius, 100m by 100m	5-6	13-14	19-23	N W	None	10-90	None	
Adelaide Wind Farm	14	Sub set	22	10	2015	10:56	11:26	30	1	Anna Corrigan	3	4712	No	Circular	50m radius, 100m by 100m	5-6	13-14	19-23	N W	None	10-90	None	

**Table F1: Weekly Mortality Monitoring Survey Record**

Project Name	Turbine Number	Treatment Group	Day	Month	Year	Start Time	End Time	Duration Min	Number Of Searchers	Searchers' Names	Days Since Last Search	Actual Area Searched M2	Dog Used	Search Area Shape	Search Area Dimension	Transect Separation M	Temp Celsius	Wind Speed	Wind Direction	Precipitation	Cloud Cover Percentage	Significant Weather	Comments
Adelaide Wind Farm	12	Sub set	22	10	2015	11:37	12:08	31	1	Anna Corrigan	3	7854	No	Circular	50m radius, 100m by 100m	5-6	13-14	19-23	N W	None	10-90	None	
Adelaide Wind Farm	7	Sub set	22	10	2015	12:25	12:57	32	1	Anna Corrigan	3	7854	No	Circular	50m radius, 100m by 100m	5-6	13-14	19-23	N W	None	10-90	None	
Adelaide Wind Farm	6	Sub set	22	10	2015	13:04	13:35	31	1	Anna Corrigan	3	7854	No	Circular	50m radius, 100m by 100m	5-6	13-14	19-23	N W	None	10-90	None	
Adelaide Wind Farm	7	Sub set	26	10	2015	8:35	9:10	35	1	Ken Edwards	4	7854	No	Circular	50m radius, 100m by 100m	5-6	9	8	E	None	30	None	
Adelaide Wind Farm	6	Sub set	26	10	2015	9:20	9:50	30	1	Ken Edwards	4	7854	No	Circular	50m radius, 100m by 100m	5-6	9	8	E	None	30	None	
Adelaide Wind Farm	12	Sub set	26	10	2015	10:10	10:40	30	1	Ken Edwards	4	7854	No	Circular	50m radius, 100m by 100m	5-6	9	8	E	None	30	None	
Adelaide Wind Farm	14	Sub set	26	10	2015	10:50	11:20	30	1	Ken Edwards	4	7854	No	Circular	50m radius, 100m by 100m	5-6	9	8	E	None	30	None	
Adelaide Wind Farm	17	Sub set	26	10	2015	11:30	12:05	35	1	Ken Edwards	4	7854	No	Circular	50m radius, 100m by 100m	5-6	9	8	E	None	30	None	
Adelaide Wind Farm	20	Sub set	26	10	2015	12:35	13:05	30	1	Ken Edwards	7	7854	No	Circular	50m radius, 100m by 100m	5-6	9	8	E	None	30	None	
Adelaide Wind Farm	22	Sub set	26	10	2015	13:10	13:40	30	1	Ken Edwards	4	7854	No	Circular	50m radius, 100m by 100m	5-6	9	8	E	None	30	None	
Adelaide Wind Farm	27	Sub set	26	10	2015	13:50	14:25	35	1	Ken Edwards	4	7854	No	Circular	50m radius, 100m by 100m	5-6	9	8	E	None	30	None	
Adelaide Wind Farm	7	Sub set	29	10	2015	8:40	9:10	30	1	Ken Edwards	3	7854	No	Circular	50m radius, 100m by 100m	5-6	5	35	SW	None	70	Rain	

**Table F1: Weekly Mortality Monitoring Survey Record**

Project Name	Turbine Number	Treatment Group	Day	Month	Year	Start Time	End Time	Duration Min	Number Of Searchers	Searchers' Names	Days Since Last Search	Actual Area Searched M2	Dog Used	Search Area Shape	Search Area Dimension	Transect Separation M	Temp Celsius	Wind Speed	Wind Direction	Precipitation	Cloud Cover Percentage	Significant Weather	Comments
Adelaide Wind Farm	6	Sub set	29	10	2015	9:20	9:55	35	1	Ken Edwards	3	7854	No	Circular	50m radius, 100m by 100m	5-6	5	35	SW	None	70	Rain	
Adelaide Wind Farm	12	Sub set	29	10	2015	10:05	10:35	30	1	Ken Edwards	3	7854	No	Circular	50m radius, 100m by 100m	5-6	5	35	SW	None	70	Rain	
Adelaide Wind Farm	14	Sub set	29	10	2015	10:45	11:15	30	1	Ken Edwards	3	7854	No	Circular	50m radius, 100m by 100m	5-6	5	35	SW	None	70	Rain	
Adelaide Wind Farm	17	Sub set	29	10	2015	11:25	12:00	35	1	Ken Edwards	3	7854	No	Circular	50m radius, 100m by 100m	5-6	5	35	SW	None	70	Rain	
Adelaide Wind Farm	19	Sub set	29	10	2015	12:25	12:55	30	1	Ken Edwards	7	7854	No	Circular	50m radius, 100m by 100m	5-6	5	35	SW	None	70	Rain	
Adelaide Wind Farm	20	Sub set	29	10	2015	13:05	13:35	30	1	Ken Edwards	3	7854	No	Circular	50m radius, 100m by 100m	5-6	5	35	SW	None	70	Rain	
Adelaide Wind Farm	22	Sub set	29	10	2015	13:45	14:15	30	1	Ken Edwards	3	7854	No	Circular	50m radius, 100m by 100m	5-6	5	35	SW	None	70	Rain	
Adelaide Wind Farm	27	Sub set	29	10	2015	14:25	15:00	35	1	Ken Edwards	3	7854	No	Circular	50m radius, 100m by 100m	5-6	5	35	SW	None	70	Rain	

**Table F2: Raptor Mortality Monitoring Survey Record**

Project Name	Turbine Number	Treatment Group	Day	Month	Year	Start Time	End Time	Duration Min	Number Of Searchers	Searchers Names	Days Since Last Search	Actual Area Searched M2	Dog Used	Search Area Shape	Search Area Dimension	Transect Separation M	Temp Celsius	Wind Speed	Wind Direction	Precipitation	Cloud Cover Percent	Significant Weather	Comments
Adelaide Wind Farm	5	Raptor	26	5	2015	8:40	9:35	55	1	Ken Edwards	28	7854	no	Circular	50m radius, 100m by 100m	5 to 6	18-26	15	SSW	None	30	None	
Adelaide Wind Farm	8	Raptor	26	5	2015	9:45	10:25	40	1	Ken Edwards	28	7854	no	Circular	50m radius, 100m by 100m	5 to 6	18-26	15	SSW	None	30	None	
Adelaide Wind Farm	9	Raptor	26	5	2015	10:35	11:20	45	1	Ken Edwards	28	7854	no	Circular	50m radius, 100m by 100m	5 to 6	18-26	15	SSW	None	30	None	
Adelaide Wind Farm	13	Raptor	26	5	2015	11:30	12:20	50	1	Ken Edwards	28	7854	no	Circular	50m radius, 100m by 100m	5 to 6	18-26	15	SSW	None	30	None	
Adelaide Wind Farm	15	Raptor	26	5	2015	12:40	13:35	55	1	Ken Edwards	28	7854	no	Circular	50m radius, 100m by 100m	5 to 6	18-26	15	SSW	None	30	None	
Adelaide Wind Farm	21	Raptor	26	5	2015	13:40	14:00	70	1	Ken Edwards	28	7854	no	Circular	50m radius, 100m by 100m	5 to 6	18-26	15	SSW	None	30	None	
Adelaide Wind Farm	26	Raptor	26	5	2015	15:10	14:50	40	1	Ken Edwards	28	7854	no	Circular	50m radius, 100m by 100m	5 to 6	18-26	15	SSW	None	30	None	
Adelaide Wind Farm	18	Raptor	27	5	2015	8:05	8:35	30	1	Ken Edwards	29	7854	no	Circular	50m radius, 100m by 100m	5 to 6	15	6	SE	None	0	Rain	Makeup for missed turbine
Adelaide Wind Farm	8	Raptor	19	6	2015	10:40	11:40	60	1	Ken Edwards	25	7854	no	Circular	50m radius, 100m by 100m	5 to 6	22	6	NW	None	30	Light Rain	
Adelaide Wind Farm	15	Raptor	19	6	2015	11:50	12:55	65	1	Ken Edwards	25	7854	no	Circular	50m radius, 100m by 100m	5 to 6	22	6	NW	None	30	Light Rain	
Adelaide Wind Farm	26	Raptor	19	6	2015	13:20	13:50	30	1	Ken Edwards	25	7854	no	Circular	50m radius, 100m by 100m	5 to 6	22	6	NW	None	30	Light Rain	

**Table F2: Raptor Mortality Monitoring Survey Record**

Project Name	Turbine Number	Treatment Group	Day	Month	Year	Start Time	End Time	Duration Min	Number Of Searchers	Searchers Names	Days Since Last Search	Actual Area Searched M2	Dog Used	Search Area Shape	Search Area Dimension	Transect Separation M	Temp Celsius	Wind Speed	Wind Direction	Precipitation	Cloud Cover Percent	Significant Weather	Comments
Adelaide Wind Farm	21	Raptor	19	6	2015	14:00	15:35	95	1	Ken Edwards	25	7854	no	Circular	50m radius, 100m by 100m	5 to 6	22	6	NW	None	30	Light Rain	
Adelaide Wind Farm	5	Raptor	19	6	2015	15:45	16:35	50	1	Ken Edwards	25	7854	no	Circular	50m radius, 100m by 100m	5 to 6	22	6	NW	None	30	Light Rain	
Adelaide Wind Farm	9	Raptor	21	6	2015	12:45	14:15	90	1	Ken Edwards	27	7854	no	Circular	50m radius, 100m by 100m	5 to 6	22	18	NW	None	20	None	
Adelaide Wind Farm	13	Raptor	21	6	2015	14:20	15:00	40	1	Ken Edwards	27	7854	no	Circular	50m radius, 100m by 100m	5 to 6	22	18	NW	None	20	None	
Adelaide Wind Farm	18	Raptor	21	6	2015	15:10	16:20	70	1	Ken Edwards	26	7854	no	Circular	50m radius, 100m by 100m	5 to 6	22	18	NW	None	20	None	
Adelaide Wind Farm	8	Raptor	21	7	2015	8:30	10:00	90	1	Ken Edwards	32	7854	no	Circular	50m radius, 100m by 100m	5 to 6	20-23	18	NW	None	10	None	
Adelaide Wind Farm	9	Raptor	21	7	2015	10:05	11:25	80	1	Ken Edwards	30	7854	no	Circular	50m radius, 100m by 100m	5 to 6	20-23	18	NW	None	10	None	
Adelaide Wind Farm	13	Raptor	21	7	2015	11:35	13:00	85	1	Ken Edwards	30	7854	no	Circular	50m radius, 100m by 100m	5 to 6	20-23	18	NW	None	10	None	
Adelaide Wind Farm	15	Raptor	21	7	2015	13:10	14:20	70	1	Ken Edwards	32	7854	no	Circular	50m radius, 100m by 100m	5 to 6	20-23	18	NW	None	10	None	
Adelaide Wind Farm	18	Raptor	21	7	2015	14:30	15:40	70	1	Ken Edwards	30	7854	no	Circular	50m radius, 100m by 100m	5 to 6	20-23	18	NW	None	10	None	
Adelaide Wind Farm	5	Raptor	21	7	2015	15:55	16:55	60	1	Ken Edwards	32	7854	no	Circular	50m radius, 100m by 100m	5 to 6	20-23	18	NW	None	10	None	

**Table F2: Raptor Mortality Monitoring Survey Record**

Project Name	Turbine Number	Treatment Group	Day	Month	Year	Start Time	End Time	Duration Min	Number Of Searchers	Searchers Names	Days Since Last Search	Actual Area Searched M2	Dog Used	Search Area Shape	Search Area Dimension	Transect Separation M	Temp Celsius	Wind Speed	Wind Direction	Precipitation	Cloud Cover Percent	Significant Weather	Comments
Adelaide Wind Farm	21	Raptor	22	7	2015	9:00	10:45	105	1	Ken Edwards	33	7854	no	Circular	50m radius, 100m by 100m	5 to 6	23	21	SW	None	0	None	
Adelaide Wind Farm	26	Raptor	22	7	2015	10:53	12:00	75	1	Ken Edwards	33	7854	no	Circular	50m radius, 100m by 100m	5 to 6	23	21	SW	None	0	None	
Adelaide Wind Farm	5	Raptor	25	8	2015	8:40	9:45	65	1	Ken Edwards	35	7854	no	Circular	50m radius, 100m by 100m	5 to 6	14	14	W	None	100	None	
Adelaide Wind Farm	8	Raptor	25	8	2015	9:55	10:55	60	1	Ken Edwards	35	7854	no	Circular	50m radius, 100m by 100m	5 to 6	14	14	W	None	100	None	
Adelaide Wind Farm	9	Raptor	25	8	2015	11:05	12:05	60	1	Ken Edwards	35	7854	no	Circular	50m radius, 100m by 100m	5 to 6	14	14	W	None	100	None	
Adelaide Wind Farm	13	Raptor	25	8	2015	12:25	13:05	40	1	Ken Edwards	35	7854	no	Circular	50m radius, 100m by 100m	5 to 6	14	14	W	None	100	None	
Adelaide Wind Farm	15	Raptor	25	8	2015	13:15	14:45	90	1	Ken Edwards	35	7854	no	Circular	50m radius, 100m by 100m	5 to 6	14	14	W	None	100	None	
Adelaide Wind Farm	18	Raptor	25	8	2015	14:55	15:55	60	1	Ken Edwards	35	7854	no	Circular	50m radius, 100m by 100m	5 to 6	14	14	W	None	100	None	
Adelaide Wind Farm	21	Raptor	25	8	2015	16:00	17:40	100	1	Ken Edwards	34	7854	no	Circular	50m radius, 100m by 100m	5 to 6	14	14	W	None	100	None	
Adelaide Wind Farm	26	Raptor	25	8	2015	17:45	18:25	40	1	Ken Edwards	34	7854	no	Circular	50m radius, 100m by 100m	5 to 6	14	14	W	None	100	None	
Adelaide Wind Farm	26	Raptor	21	9	2015	7:54	8:25	31	1	Anna Corrigan	27	7854	no	Circular	50m radius, 100m by 100m	5 to 6	10-21	12-18	E	None	15	None	



Table F2: Raptor Mortality Monitoring Survey Record

Project Name	Turbine Number	Treatment Group	Day	Month	Year	Start Time	End Time	Duration Min	Number Of Searchers	Searchers Names	Days Since Last Search	Actual Area Searched M2	Dog Used	Search Area Shape	Search Area Dimension	Transect Separation M	Temp Celsius	Wind Speed	Wind Direction	Precipitation	Cloud Cover Percent	Significant Weather	Comments
Adelaide Wind Farm	18	Raptor	21	9	2015	8:43	9:15	32	1	Anna Corrigan	27	7854	no	Circular	50m radius, 100m by 100m	5 to 6	10-21	12-18	E	None	15	None	
Adelaide Wind Farm	15	Raptor	21	9	2015	9:34	10:15	41	1	Anna Corrigan	27	7854	no	Circular	50m radius, 100m by 100m	5 to 6	10-21	12-18	E	None	15	None	
Adelaide Wind Farm	13	Raptor	21	9	2015	10:42	11:21	39	1	Anna Corrigan	27	7854	no	Circular	50m radius, 100m by 100m	5 to 6	10-21	12-18	E	None	15	None	
Adelaide Wind Farm	5	Raptor	21	9	2015	11:35	12:12	37	1	Anna Corrigan	27	7854	no	Circular	50m radius, 100m by 100m	5 to 6	10-21	12-18	E	None	15	None	White-tailed deer observed in survey area
Adelaide Wind Farm	8	Raptor	21	9	2015	12:29	13:07	38	1	Anna Corrigan	27	7854	no	Circular	50m radius, 100m by 100m	5 to 6	10-21	12-18	E	None	15	None	
Adelaide Wind Farm	9	Raptor	21	9	2015	13:19	14:02	43	1	Anna Corrigan	27	7854	no	Circular	50m radius, 100m by 100m	5 to 6	10-21	12-18	E	None	15	None	2 Turkey Vultures seen flying near turbine
Adelaide Wind Farm	21	Raptor	21	9	2015	16:15	17:05	50	1	Anna Corrigan	27	7854	no	Circular	50m radius, 100m by 100m	5 to 6	10-21	12-18	E	None	15	None	
Adelaide Wind Farm	26	Raptor	15	10	2015	8:36	9:10	34	1	Anna Corrigan	24	7854	no	Circular	50m radius, 100m by 100m	5 to 6	9-17	12-38	SW	Drizzle	30-70	Drizzle	Survey area all class 1
Adelaide Wind Farm	15	Raptor	15	10	2015	9:26	9:59	33	1	Anna Corrigan	24	7854	no	Circular	50m radius, 100m by 100m	5 to 6	9-17	12-38	SW	Drizzle	30-70	Drizzle	Survey area all class 1
Adelaide Wind Farm	18	Raptor	15	10	2015	10:11	10:45	34	1	Anna Corrigan	24	7854	no	Circular	50m radius, 100m by 100m	5 to 6	9-17	12-38	SW	Drizzle	30-70	Drizzle	Survey area mix of class 1, 2, and 3
Adelaide Wind Farm	9	Raptor	15	10	2015	11:21	11:57	36	1	Anna Corrigan	24	7854	no	Circular	50m radius, 100m by 100m	5 to 6	9-17	12-38	SW	Drizzle	30-70	Drizzle	Survey area mix of class 1 and 4, mostly 4

Table F2: Raptor Mortality Monitoring Survey Record

Project Name	Turbine Number	Treatment Group	Day	Month	Year	Start Time	End Time	Duration Min	Number Of Searchers	Searchers Names	Days Since Last Search	Actual Area Searched M2	Dog Used	Search Area Shape	Search Area Dimension	Transect Separation M	Temp Celsius	Wind Speed	Wind Direction	Precipitation	Cloud Cover Percent	Significant Weather	Comments
Adelaide Wind Farm	5	Raptor	15	10	2015	12:23	12:55	32	1	Anna Corrigan	24	7854	no	Circular	50m radius, 100m by 100m	5 to 6	9-17	12-38	SW	Drizzle	30-70	Drizzle	Survey area mix of class 1, 2, and 3
Adelaide Wind Farm	8	Raptor	15	10	2015	13:04	13:37	33	1	Anna Corrigan	24	7854	no	Circular	50m radius, 100m by 100m	5 to 6	9-17	12-38	SW	Drizzle	30-70	Drizzle	Survey area mix of all classes, mostly class 4
Adelaide Wind Farm	13	Raptor	15	10	2015	13:48	14:08	33	1	Anna Corrigan	24	7854	no	Circular	50m radius, 100m by 100m	5 to 6	9-17	12-38	SW	Drizzle	30-70	Drizzle	Survey area mix of all classes, mostly class 2. First 13 minutes searched from 10:58 to 11:11, but was asked to leave survey area due to maintenance
Adelaide Wind Farm	21	Raptor	15	10	2015	15:20	15:52	32	1	Anna Corrigan	24	7854	no	Circular	50m radius, 100m by 100m	5 to 6	9-17	12-38	SW	Drizzle	30-70	Drizzle	Survey area mix of all classes, mostly class 3
Adelaide Wind Farm	7	Subset	5	11	2015	8:40	9:10	30	1	Ken Edwards	7	7854	No	Circular	50m radius, 100m by 100m	5-6	14	10	S	None	30	None	
Adelaide Wind Farm	6	Subset	5	11	2015	9:15	9:50	35	1	Ken Edwards	7	7854	No	Circular	50m radius, 100m by 100m	5-6	14	10	S	None	30	None	
Adelaide Wind Farm	11	Subset	5	11	2015	10:05	10:35	30	1	Ken Edwards	7	7854	No	Circular	50m radius, 100m by 100m	5-6	14	10	S	None	30	None	
Adelaide Wind Farm	14	Subset	5	11	2015	10:45	11:20	35	1	Ken Edwards	7	7854	No	Circular	50m radius, 100m by 100m	5-6	14	10	S	None	30	None	

**Table F2: Raptor Mortality Monitoring Survey Record**

Project Name	Turbine Number	Treatment Group	Day	Month	Year	Start Time	End Time	Duration Min	Number Of Searchers	Searchers Names	Days Since Last Search	Actual Area Searched M2	Dog Used	Search Area Shape	Search Area Dimension	Transect Separation M	Temp Celsius	Wind Speed	Wind Direction	Precipitation	Cloud Cover Percent	Significant Weather	Comments
Adelaide Wind Farm	17	Subset	5	11	2015	11:30	12:00	30	1	Ken Edwards	7	7854	No	Circular	50m radius, 100m by 100m	5-6	14	10	S	None	30	None	
Adelaide Wind Farm	19	Subset	5	11	2015	12:10	12:40	30	1	Ken Edwards	7	7854	No	Circular	50m radius, 100m by 100m	5-6	14	10	S	None	30	None	
Adelaide Wind Farm	20	Subset	5	11	2015	12:50	13:20	30	1	Ken Edwards	7	7854	No	Circular	50m radius, 100m by 100m	5-6	14	10	S	None	30	None	
Adelaide Wind Farm	22	Subset	5	11	2015	13:30	14:10	40	1	Ken Edwards	7	7854	No	Circular	50m radius, 100m by 100m	5-6	14	10	S	None	30	None	
Adelaide Wind Farm	27	Subset	5	11	2015	14:20	15:00	40	1	Ken Edwards	7	7854	No	Circular	50m radius, 100m by 100m	5-6	14	10	S	None	30	None	
Adelaide Wind Farm	7	Subset	12	11	2015	8:35	9:05	30	1	Ken Edwards	7	7854	No	Circular	50m radius, 100m by 100m	5-6	9	26	SE	None	100	Rain	
Adelaide Wind Farm	6	Subset	12	11	2015	9:10	9:40	30	1	Ken Edwards	7	7854	No	Circular	50m radius, 100m by 100m	5-6	9	26	SE	None	100	Rain	
Adelaide Wind Farm	12	Subset	12	11	2015	9:50	10:15	25	1	Ken Edwards	14	7854	No	Circular	50m radius, 100m by 100m	5-6	9	26	SE	None	100	Rain	
Adelaide Wind Farm	14	Subset	12	11	2015	10:25	11:05	40	1	Ken Edwards	7	7854	No	Circular	50m radius, 100m by 100m	5-6	9	26	SE	None	100	Rain	
Adelaide Wind Farm	17	Subset	12	11	2015	11:15	11:45	30	1	Ken Edwards	7	7854	No	Circular	50m radius, 100m by 100m	5-6	9	26	SE	None	100	Rain	
Adelaide Wind Farm	20	Subset	12	11	2015	11:55	12:25	30	1	Ken Edwards	7	7854	No	Circular	50m radius, 100m by 100m	5-6	9	26	SE	None	100	Rain	

**Table F2: Raptor Mortality Monitoring Survey Record**

Project Name	Turbine Number	Treatment Group	Day	Month	Year	Start Time	End Time	Duration Min	Number Of Searchers	Searchers Names	Days Since Last Search	Actual Area Searched M2	Dog Used	Search Area Shape	Search Area Dimension	Transect Separation M	Temp Celsius	Wind Speed	Wind Direction	Precipitation	Cloud Cover Percent	Significant Weather	Comments
Adelaide Wind Farm	22	Subset	12	11	2015	12:35	13:15	40	1	Ken Edwards	7	7854	No	Circular	50m radius, 100m by 100m	5-6	9	26	SE	None	100	Rain	
Adelaide Wind Farm	27	Subset	12	11	2015	13:20	13:50	30	1	Ken Edwards	7	7854	No	Circular	50m radius, 100m by 100m	5-6	9	26	SE	None	100	Rain	
Adelaide Wind Farm	19	Subset	12	11	2015	14:05	14:40	35	1	Ken Edwards	7	7854	No	Circular	50m radius, 100m by 100m	5-6	9	26	SE	None	100	Rain	
Adelaide Wind Farm	11	Subset	12	11	2015	14:50	15:20	30	1	Ken Edwards	7	7854	No	Circular	50m radius, 100m by 100m	5-6	9	26	SE	None	100	Rain	
Adelaide Wind Farm	6	Subset	19	11	2015	8:40	9:15	35	1	Ken Edwards	7	7854	No	Circular	50m radius, 100m by 100m	5-6	13	26	SW	None	30	Rain	
Adelaide Wind Farm	11	Subset	19	11	2015	9:30	10:00	30	1	Ken Edwards	7	7854	No	Circular	50m radius, 100m by 100m	5-6	13	26	SW	None	30	Rain	
Adelaide Wind Farm	12	Subset	19	11	2015	10:05	10:40	35	1	Ken Edwards	7	7854	No	Circular	50m radius, 100m by 100m	5-6	13	26	SW	None	30	Rain	
Adelaide Wind Farm	14	Subset	19	11	2015	10:45	11:20	35	1	Ken Edwards	7	7854	No	Circular	50m radius, 100m by 100m	5-6	13	26	SW	None	30	Rain	
Adelaide Wind Farm	17	Subset	19	11	2015	11:30	12:00	30	1	Ken Edwards	7	7854	No	Circular	50m radius, 100m by 100m	5-6	13	26	SW	None	30	Rain	
Adelaide Wind Farm	20	Subset	19	11	2015	12:35	13:10	35	1	Ken Edwards	7	7854	No	Circular	50m radius, 100m by 100m	5-6	13	26	SW	None	30	Rain	
Adelaide Wind Farm	22	Subset	19	11	2015	13:20	13:50	30	1	Ken Edwards	7	7854	No	Circular	50m radius, 100m by 100m	5-6	13	26	SW	None	30	Rain	

**Table F2: Raptor Mortality Monitoring Survey Record**

Project Name	Turbine Number	Treatment Group	Day	Month	Year	Start Time	End Time	Duration Min	Number Of Searchers	Searchers Names	Days Since Last Search	Actual Area Searched M2	Dog Used	Search Area Shape	Search Area Dimension	Transect Separation M	Temp Celsius	Wind Speed	Wind Direction	Precipitation	Cloud Cover Percent	Significant Weather	Comments
Adelaide Wind Farm	27	Subset	19	11	2015	14:00	14:40	40	1	Ken Edwards	7	7854	No	Circular	50m radius, 100m by 100m	5-6	13	26	SW	None	30	Rain	
Adelaide Wind Farm	7	Subset	19	11	2015	14:50	15:20	30	1	Ken Edwards	7	7854	No	Circular	50m radius, 100m by 100m	5-6	13	26	SW	None	30	Rain	
Adelaide Wind Farm	5	Raptor	20	11	2015	8:45	9:20	35	1	Ken Edwards	39	7854	no	Circular	50m radius, 100m by 100m	5 to 6	4	23	W	None	20	None	
Adelaide Wind Farm	8	Raptor	20	11	2015	9:30	10:10	40	1	Ken Edwards	39	7854	no	Circular	50m radius, 100m by 100m	5 to 6	4	23	W	None	20	None	
Adelaide Wind Farm	9	Raptor	20	11	2015	10:20	11:00	40	1	Ken Edwards	39	7854	no	Circular	50m radius, 100m by 100m	5 to 6	4	23	W	None	20	None	
Adelaide Wind Farm	13	Raptor	20	11	2015	11:15	11:50	35	1	Ken Edwards	39	7854	no	Circular	50m radius, 100m by 100m	5 to 6	4	23	W	None	20	None	
Adelaide Wind Farm	15	Raptor	20	11	2015	12:05	12:40	35	1	Ken Edwards	39	7854	no	Circular	50m radius, 100m by 100m	5 to 6	4	23	W	None	20	None	
Adelaide Wind Farm	18	Raptor	20	11	2015	12:50	13:25	35	1	Ken Edwards	39	7854	no	Circular	50m radius, 100m by 100m	5 to 6	4	23	W	None	20	None	
Adelaide Wind Farm	21	Raptor	20	11	2015	13:35	14:15	40	1	Ken Edwards	39	7854	no	Circular	50m radius, 100m by 100m	5 to 6	4	23	W	None	20	None	
Adelaide Wind Farm	26	Raptor	20	11	2015	14:25	15:00	35	1	Ken Edwards	39	7854	no	Circular	50m radius, 100m by 100m	5 to 6	4	23	W	None	20	None	
Adelaide Wind Farm	7	Subset	26	11	2015	9:00	9:31	31	1	Ken Edwards	7	n/a	No	Circular	50m radius, 100m by 100m	5-6	10	24	S	Light	100	None	

**Table F2: Raptor Mortality Monitoring Survey Record**

Project Name	Turbine Number	Treatment Group	Day	Month	Year	Start Time	End Time	Duration Min	Number Of Searchers	Searchers Names	Days Since Last Search	Actual Area Searched M2	Dog Used	Search Area Shape	Search Area Dimension	Transect Separation M	Temp Celsius	Wind Speed	Wind Direction	Precipitation	Cloud Cover Percent	Significant Weather	Comments
Adelaide Wind Farm	6	Subset	26	11	2015	9:38	10:12	34	1	Ken Edwards	7	n/a	No	Circular	50m radius, 100m by 100m	5-6	10	24	S	Light	100	None	
Adelaide Wind Farm	11	Subset	26	11	2015	10:19	10:51	32	1	Ken Edwards	7	n/a	No	Circular	50m radius, 100m by 100m	5-6	10	24	S	Light	100	None	
Adelaide Wind Farm	12	Subset	26	11	2015	11:00	11:42	42	1	Ken Edwards	7	n/a	No	Circular	50m radius, 100m by 100m	5-6	10	24	S	Light	100	None	
Adelaide Wind Farm	14	Subset	26	11	2015	12:15	12:55	40	1	Ken Edwards	7	n/a	No	Circular	50m radius, 100m by 100m	5-6	10	24	S	Light	100	None	
Adelaide Wind Farm	17	Subset	26	11	2015	13:07	13:37	30	1	Ken Edwards	7	n/a	No	Circular	50m radius, 100m by 100m	5-6	10	24	S	Light	100	None	
Adelaide Wind Farm	20	Subset	26	11	2015	13:47	14:25	38	1	Ken Edwards	7	n/a	No	Circular	50m radius, 100m by 100m	5-6	10	24	S	Light	100	None	
Adelaide Wind Farm	22	Subset	26	11	2015	14:41	15:11	30	1	Ken Edwards	7	n/a	No	Circular	50m radius, 100m by 100m	5-6	10	24	S	Light	100	None	
Adelaide Wind Farm	27	Subset	26	11	2015	15:20	15:53	33	1	Ken Edwards	7	n/a	No	Circular	50m radius, 100m by 100m	5-6	10	24	S	Light	100	None	

Table F3: Missed Surveys from Weekly Monitoring

Project Name	Turbine Number	Treatment Group	Day	Month	Year	Start Time	End Time	Duration Min	Number Of Searchers	Searchers Names	Days Since Last Search	Actual Area Searched M2	Dog Used	Search Area Shape	Search Area Dimension	Transect Separation M	Temp Celsius	Wind Speed	Wind Direction	Precipitation	Cloud Cover Percent	Significant Weather	Comments
Adelaide Wind Farm	19	Subset	14	5	2015	n/a	n/a	0	1	Ken Edwards	3	0	No	Circular	50m radius, 100m by 100m	5-6	8 to 20	6	E	None	0	None	Under maintenance
Adelaide Wind Farm	11	Subset	14	5	2015	n/a	n/a	0	1	Ken Edwards	3	0	No	Circular	50m radius, 100m by 100m	5-6	8 to 20	6	E	None	0	None	Under maintenance
Adelaide Wind Farm	27	Subset	8	6	2015	n/a	n/a	0	1	Ken Edwards	4	0	No	Circular	50m radius, 100m by 100m	5-6	19-23	16	WSW	Rain	100	Rain	Weather - lightning
Adelaide Wind Farm	22	Subset	15	6	2015	n/a	n/a	0	1	Anna Corrigan	4	0	No	Circular	50m radius, 100m by 100m	5-6	23-24	12	W	Drizzle	60-100	Fog/Rain	Construction throughout entire day - unable to survey
Adelaide Wind Farm	14	Subset	22	6	2015	n/a	n/a	0	1	Ken Edwards	4	0	No	Circular	50m radius, 100m by 100m	5-6	15-26	20	S	None	50	Rain	Lightning
Adelaide Wind Farm	11	Subset	22	6	2015	n/a	n/a	0	1	Ken Edwards	4	0	No	Circular	50m radius, 100m by 100m	5-6	15-26	20	S	None	50	Rain	Lightning
Adelaide Wind Farm	7	Subset	22	6	2015	n/a	n/a	0	1	Ken Edwards	4	0	No	Circular	50m radius, 100m by 100m	5-6	15-26	20	S	None	50	Rain	Lightning
Adelaide Wind Farm	12	Subset	25	6	2015	n/a	n/a	0	1	Ken Edwards	3	0	No	Circular	50m radius, 100m by 100m	5-6	24	6	S	None	100	None	Road construction - unable to survey
Adelaide Wind Farm	17	Subset	25	6	2015	n/a	n/a	0	1	Ken Edwards	3	0	No	Circular	50m radius, 100m by 100m	5-6	24	6	S	None	100	None	Road construction - unable to survey
Adelaide Wind Farm	12	Subset	29	6	2015	n/a	n/a	0	1	Ken Edwards	7	0	No	Circular	50m radius, 100m by 100m	5-6	19-25	6	S	None	30	Rain	Did not indicate on sheet why this one wasn't searched
Adelaide Wind Farm	7	Subset	2	7	2015	n/a	n/a	0	1	Ken Edwards	3	0	No	Circular	50m radius, 100m by 100m	5-6	16-21	5	N	None	10	None	Under maintenance

Table F3: Missed Surveys from Weekly Monitoring

Project Name	Turbine Number	Treatment Group	Day	Month	Year	Start Time	End Time	Duration Min	Number Of Searchers	Searchers Names	Days Since Last Search	Actual Area Searched M2	Dog Used	Search Area Shape	Search Area Dimension	Transect Separation M	Temp Celsius	Wind Speed	Wind Direction	Precipitation	Cloud Cover Percent	Significant Weather	Comments
Adelaide Wind Farm	7	Subset	6	7	2015	n/a	n/a	0	1	Ken Edwards	7	0	No	Circular	50m radius, 100m by 100m	5-6	27	15	SE	None	0	None	Under maintenance
Adelaide Wind Farm	22	Subset	9	7	2015	n/a	n/a	0	1	Ken Edwards	3	0	No	Circular	50m radius, 100m by 100m	5-6	18	6	E	Light Rain	80	Light Rain	Construction/ tile
Adelaide Wind Farm	20	Subset	23	7	2015	n/a	n/a	0	1	Ken Edwards	3	0	No	Circular	50m radius, 100m by 100m	5-6	20-24	10	NW	None	0	None	Unable to survey due to farming activities present.
Adelaide Wind Farm	20	Subset	27	7	2015	n/a	n/a	0	1	Ken Edwards	7	0	No	Circular	50m radius, 100m by 100m	5-6	27-31	2	SE	None	0	None	Unable to survey due to farming activities present.
Adelaide Wind Farm	14	Subset	30	7	2015	n/a	n/a	0	1	Ken Edwards	3	0	No	Circular	50m radius, 100m by 100m	5-6	19-30	14	W	None	0	Light Rain	Unable to survey due to farming/maintenance activities present.
Adelaide Wind Farm	12	Subset	17	8	2015	n/a	n/a	0	1	Ken Edwards	4	0	No	Circular	50m radius, 100m by 100m	5-6	25-30	11	SW	None	0	None	Unable to complete survey safely due to ongoing maintenance throughout day.
Adelaide Wind Farm	19	Subset	20	8	2015	n/a	n/a	0	1	Ken Edwards	3	0	No	Circular	50m radius, 100m by 100m	5-6	19	14	W	Light Rain	100	Rain	Turbine not surveyed due to road maintenance blocking entrance
Adelaide Wind Farm	20	Subset	24	8	2015	n/a	n/a	0	1	Ken Edwards	4	0	No	Circular	50m radius, 100m by 100m	5-6	15	11	W	None	0	Light Rain	Turbine not surveyed due to farming activities
Adelaide Wind Farm	27	Subset	27	8	2015	n/a	n/a	0	1	Ken Edwards	3	0	No	Circular	50m radius, 100m by 100m	5-6	14	6	W	None	90	Light Rain	Unable to complete survey safely due to ongoing maintenance throughout day.
Adelaide Wind Farm	7	Subset	3	9	2015	n/a	n/a	0	1	Ken Edwards	3	0	No	Circular	50m radius, 100m by 100m	5-6	25-30	3	W	None	100	None	Unable to search due to lightning
Adelaide Wind Farm	20	Subset	3	9	2015	n/a	n/a	0	1	Ken Edwards	3	0	No	Circular	50m radius, 100m by 100m	5-6	25-30	3	W	None	100	None	Unable to search due to lightning



Table F3: Missed Surveys from Weekly Monitoring

Project Name	Turbine Number	Treatment Group	Day	Month	Year	Start Time	End Time	Duration Min	Number Of Searchers	Searchers Names	Days Since Last Search	Actual Area Searched M2	Dog Used	Search Area Shape	Search Area Dimension	Transect Separation M	Temp Celsius	Wind Speed	Wind Direction	Precipitation	Cloud Cover Percent	Significant Weather	Comments
Adelaide Wind Farm	22	Subset	3	9	2015	n/a	n/a	0	1	Ken Edwards	3	0	No	Circular	50m radius, 100m by 100m	5-6	25-30	3	W	None	100	None	Unable to search due to lightning
Adelaide Wind Farm	27	Subset	3	9	2015	n/a	n/a	0	1	Ken Edwards	3	0	No	Circular	50m radius, 100m by 100m	5-6	25-30	3	W	None	100	None	Unable to search due to lightning
Adelaide Wind Farm	22	Subset	10	9	2015	n/a	n/a	0	1	Ken Edwards	3	0	No	Circular	50m radius, 100m by 100m	5-6	19-25	6	NE	None	10	Light Rain	Unable to search due to maintenance
Adelaide Wind Farm	20	Subset	12	10	2015	n/a	n/a	0	1	Ken Edwards	4	0	No	Circular	50m radius, 100m by 100m	5-6	18	23	S	None	0	None	Unable to search due to farming
Adelaide Wind Farm	19	Subset	15	10	2015	n/a	n/a	0	1	Ken Edwards	3	0	No	Circular	50m radius, 100m by 100m	5-6	14	18	SW	None	20	None	Could not search due to maintenance
Adelaide Wind Farm	11	Subset	19	10	2015	n/a	n/a	0	1	Anna Corrigan	4	0	No	Circular	50m radius, 100m by 100m	5-6	2-14	22-38	SW	None	10-100	Snow	Could not search due to maintenance
Adelaide Wind Farm	20	Subset	22	10	2015	n/a	n/a	0	1	Ken Edwards	3	0	No	Circular	50m radius, 100m by 100m	5-6	13-14	19-23	NW	None	10-90	None	Could not search due to maintenance
Adelaide Wind Farm	11	Subset	22	10	2015	n/a	n/a	0	1	Ken Edwards	7	0	No	Circular	50m radius, 100m by 100m	5-6	13-14	19-23	NW	None	10-90	None	Could not search due to maintenance
Adelaide Wind Farm	11	Subset	26	10	2015	n/a	n/a	0	1	Ken Edwards	11	0	No	Circular	50m radius, 100m by 100m	5-6	9	8	E	None	30	None	Could not search due to maintenance
Adelaide Wind Farm	19	Subset	26	10	2015	n/a	n/a	0	1	Ken Edwards	4	0	No	Circular	50m radius, 100m by 100m	5-6	9	8	E	None	30	None	Could not search due to maintenance
Adelaide Wind Farm	11	Subset	29	10	2015	n/a	n/a	0	1	Ken Edwards	14	0	No	Circular	50m radius, 100m by 100m	5-6	5	35	SW	None	70	Rain	

**Table F4: Missed Surveys from Raptor Monitoring**

Project Name	Turbine Number	Treatment Group	Day	Month	Year	Start Time	End Time	Duration Min	Number of Searchers	Searchers Names	Days Since Last Search	Actual Area Searched M2	Do g Us ed	Search Area Shape	Search Area Dimension	Transect Separation M	Temp Celsius	Wind Speed	Wind Direction	Precipitation	Cloud Cover Percentage	Significant Weather	Comments
Adelaide Wind Farm	12	Subset	5	11	2015	n/a	n/a	n/a	1	Ken Edwards	7	0	No	Circular	50m radius, 100m by 100m	5-6	14	10	S	None	30	None	Maintenance
Adelaide Wind Farm	19	Subset	19	11	2015	n/a	n/a	n/a	1	Ken Edwards	14	0	No	Circular	50m radius, 100m by 100m	5-6	13	26	SW	None	30	Rain	Maintenance
Adelaide Wind Farm	19	Subset	26	11	2015	n/a	n/a	n/a	1	Ken Edwards	21	0	No	Circular	50m radius, 100m by 100m	5-6	10	24	S	Light	100	None	Maintenance

**Table F5: Searcher Efficiency Data**

Project_Name	Year	Turbine	Treatment_Group	Searcher_Name	Dog_Used	Day_Placed	Month_Placed	Date	Season	Placed_By	Time	Time_Collected	Species_Name_Common	Species_Name_Scientific	Species_Code	Condition
Adelaide Wind Farm	2015	6	Subset	Ken Edwards	No	7	5	5/7/2015	Spring	Anna Corrigan	7:05	n/a	Red Bat	<i>Lasiurus borealis</i>	LABO	Thawed
Adelaide Wind Farm	2015	17	Subset	Ken Edwards	No	7	5	5/7/2015	Spring	Anna Corrigan	7:30	n/a	Mourning Dove	<i>Zenaida macroura</i>	MODO	Thawed
Adelaide Wind Farm	2015	22	Subset	Ken Edwards	No	7	5	5/7/2015	Spring	Anna Corrigan	7:50	n/a	Bird (small)	n/a	n/a	Thawed
Adelaide Wind Farm	2015	7	Subset	Ken Edwards	No	14	5	5/14/2015	Spring	Anna Corrigan	7:10	16:00	Silver-haired Bat	<i>Lasionycteris noctivagans</i>	LANO	Thawed
Adelaide Wind Farm	2015	14	Subset	Ken Edwards	No	14	5	5/14/2015	Spring	Anna Corrigan	7:30	n/a	Hoary Bat	<i>Lasiurus cinereus</i>	LACI	Thawed
Adelaide Wind Farm	2015	11	Subset	Ken Edwards	No	28	5	5/28/2015	Spring	Anna Corrigan	7:10	n/a	Northern Rough-winged Swallow	<i>Stelgidopteryx serripennis</i>	NRWS	Thawed
Adelaide Wind Farm	2015	12	Subset	Ken Edwards	No	28	5	5/28/2015	Spring	Anna Corrigan	7:25	June 1 @ 7:00	European Starling	<i>Sturnus vulgaris</i>	EUST	Thawed
Adelaide Wind Farm	2015	19	Subset	Ken Edwards	No	28	5	5/28/2015	Spring	Anna Corrigan	7:40	n/a	Silver-haired Bat	<i>Lasionycteris noctivagans</i>	LANO	Thawed
Adelaide Wind Farm	2015	6	Subset	Ken Edwards	No	1	6	6/1/2015	Spring	Anna Corrigan	7:30	n/a	White-breasted Nuthatch	<i>Sitta carolinensis</i>	WBNU	Thawed
Adelaide Wind Farm	2015	7	Subset	Ken Edwards	No	1	6	6/1/2015	Spring	Anna Corrigan	7:45	17:30	Silver-haired Bat	<i>Lasionycteris noctivagans</i>	LANO	Thawed
Adelaide Wind Farm	2015	20	Subset	Ken Edwards	No	4	6	6/4/2015	Spring	Anna Corrigan	7:15	n/a	Cliff Swallow	<i>Petrochelidon pyrrhonota</i>	CLSW	Thawed
Adelaide Wind Farm	2015	27	Subset	Ken Edwards	No	4	6	6/4/2015	Spring	Anna Corrigan	7:45	June 5 @ 12:00	Big Brown Bat	<i>Eptesicus fuscus</i>	EPFU	Thawed
Adelaide Wind Farm	2015	27	Subset	Ken Edwards	No	4	6	6/4/2015	Spring	Anna Corrigan	7:50	n/a	Horned Lark	<i>Eremophila alpestris</i>	HOLA	Thawed
Adelaide Wind Farm	2015	6	Subset	Ken Edwards	No	8	6	6/8/2015	Spring	Sam Soehn	7:00	n/a	Hoary Bat	<i>Lasiurus cinereus</i>	LACI	Thawed
Adelaide Wind Farm	2015	12	Subset	Ken Edwards	No	8	6	6/8/2015	Spring	Sam Soehn	7:15	n/a	Bird	n/a	n/a	Thawed
Adelaide Wind Farm	2015	17	Subset	Ken Edwards	No	8	6	6/8/2015	Spring	Sam Soehn	7:30	n/a	Bird	n/a	n/a	Thawed
Adelaide Wind Farm	2015	19	Subset	Ken Edwards	No	22	6	6/22/2015	Spring	Sam Soehn	7:20	n/a	Bird	n/a	n/a	Thawed
Adelaide Wind Farm	2015	27	Subset	Ken Edwards	No	22	6	6/22/2015	Spring	Sam Soehn	7:35	n/a	Hoary Bat	<i>Lasiurus cinereus</i>	LACI	Thawed
Adelaide Wind Farm	2015	11	Subset	Ken Edwards	No	25	6	6/25/2015	Spring	Sam Soehn	6:48	June 26 @ 2:45	Bird	n/a	n/a	Thawed
Adelaide Wind Farm	2015	14	Subset	Ken Edwards	No	25	6	6/25/2015	Spring	Sam Soehn	7:04	June 26 @ 3:00	Hoary Bat	<i>Lasiurus cinereus</i>	LACI	Thawed
Adelaide Wind Farm	2015	22	Subset	Ken Edwards	No	25	6	6/25/2015	Spring	Sam Soehn	7:22	June 26 @ 3:20	Hoary Bat	<i>Lasiurus cinereus</i>	LACI	Thawed
Adelaide Wind Farm	2015	7	Subset	Ken Edwards	No	29	6	6/29/2015	Spring	Sam Soehn	7:07	n/a	Bat	n/a	n/a	Thawed
Adelaide Wind Farm	2015	14	Subset	Ken Edwards	No	29	6	6/29/2015	Spring	Sam Soehn	7:38	n/a	Bird	n/a	n/a	Thawed
Adelaide Wind Farm	2015	20	Subset	Ken Edwards	No	29	6	6/29/2015	Spring	Sam Soehn	7:52	n/a	Bat	n/a	n/a	Thawed
Adelaide Wind Farm	2015	11	Subset	Ken Edwards	No	9	7	7/9/2015	Summer	Sam Soehn	6:57	n/a	Bat	n/a	n/a	Thawed
Adelaide Wind Farm	2015	12	Subset	Ken Edwards	No	9	7	7/9/2015	Summer	Sam Soehn	7:09	n/a	Bird (small)	n/a	n/a	Thawed
Adelaide Wind Farm	2015	17	Subset	Ken Edwards	No	16	7	7/16/2015	Summer	Sam Soehn	7:40	n/a	Mourning Dove	<i>Zenaida macroura</i>	MODO	Thawed
Adelaide Wind Farm	2015	22	Subset	Ken Edwards	No	16	7	7/16/2015	Summer	Sam Soehn	8:00	n/a	Bird	n/a	n/a	Thawed
Adelaide Wind Farm	2015	27	Subset	Ken Edwards	No	16	7	7/16/2015	Summer	Sam Soehn	8:09	6:20	Big Brown Bat	<i>Eptesicus fuscus</i>	EPFU	Thawed
Adelaide Wind Farm	2015	7	Subset	Ken Edwards	No	23	7	7/23/2015	Summer	Anna Corrigan	7:00	n/a	American Robin	<i>Turdus migratorius</i>	AMRO	Thawed
Adelaide Wind Farm	2015	6	Subset	Ken Edwards	No	23	7	7/23/2015	Summer	Anna Corrigan	7:10	17:15	Silver-haired Bat	<i>Lasionycteris noctivagans</i>	LANO	Thawed
Adelaide Wind Farm	2015	17	Subset	Ken Edwards	No	23	7	7/23/2015	Summer	Anna Corrigan	7:30	17:30	Red Bat	<i>Lasiurus borealis</i>	LABO	Thawed
Adelaide Wind Farm	2015	27	Subset	Ken Edwards	No	30	7	7/30/2015	Summer	Sam Soehn	6:33	n/a	Bird	n/a	n/a	Thawed
Adelaide Wind Farm	2015	12	Subset	Ken Edwards	No	30	7	7/30/2015	Summer	Sam Soehn	7:01	17:30	Hoary Bat	<i>Lasiurus cinereus</i>	LACI	Thawed
Adelaide Wind Farm	2015	14	Subset	Ken Edwards	No	7	8	8/7/2015	Summer	Sam Soehn	7:05	16:10	Bird	n/a	n/a	Thawed
Adelaide Wind Farm	2015	19	Subset	Ken Edwards	No	7	8	8/7/2015	Summer	Sam Soehn	7:15	n/a	Red Bat	<i>Lasiurus borealis</i>	LABO	Thawed
Adelaide Wind Farm	2015	20	Subset	Ken Edwards	No	7	8	8/7/2015	Summer	Sam Soehn	7:25	n/a	Bird	n/a	n/a	Thawed
Adelaide Wind Farm	2015	6	Subset	Ken Edwards	No	13	8	8/13/2015	Summer	Sam Soehn	7:06	16:28	Bird	n/a	n/a	Thawed
Adelaide Wind Farm	2015	11	Subset	Ken Edwards	No	13	8	8/13/2015	Summer	Sam Soehn	7:18	n/a	Hoary Bat	<i>Lasiurus cinereus</i>	LACI	Thawed
Adelaide Wind Farm	2015	22	Subset	Ken Edwards	No	13	8	8/13/2015	Summer	Sam Soehn	7:35	n/a	Hoary Bat	<i>Lasiurus cinereus</i>	LACI	Thawed
Adelaide Wind Farm	2015	11	Subset	Ken Edwards	No	20	8	8/20/2015	Summer	Sam Soehn	6:35	n/a	Bird	n/a	n/a	Thawed
Adelaide Wind Farm	2015	12	Subset	Ken Edwards	No	20	8	8/20/2015	Summer	Sam Soehn	6:46	n/a	Bird	n/a	n/a	Thawed
Adelaide Wind Farm	2015	6	Subset	Ken Edwards	No	20	8	8/20/2015	Summer	Sam Soehn	7:09	n/a	Big Brown Bat	<i>Eptesicus fuscus</i>	EPFU	Thawed
Adelaide Wind Farm	2015	6	Subset	Ken Edwards	No	27	8	8/27/2015	Summer	Anna Corrigan	6:55	n/a	Cliff Swallow	<i>Petrochelidon pyrrhonota</i>	CLSW	Thawed
Adelaide Wind Farm	2015	11	Subset	Ken Edwards	No	27	8	8/27/2015	Summer	Anna Corrigan	7:10	n/a	American Redstart	<i>Setophaga ruticilla</i>	AMRE	Thawed
Adelaide Wind Farm	2015	14	Subset	Ken Edwards	No	27	8	8/27/2015	Summer	Anna Corrigan	7:25	n/a	Hoary Bat	<i>Lasiurus cinereus</i>	LACI	Thawed
Adelaide Wind Farm	2015	12	Subset	Ken Edwards	No	3	9	9/3/2015	Fall	Anna Corrigan	6:45	15:00	American Robin	<i>Turdus migratorius</i>	AMRO	Thawed
Adelaide Wind Farm	2015	17	Subset	Ken Edwards	No	3	9	9/3/2015	Fall	Anna Corrigan	7:05	n/a	Hoary Bat	<i>Lasiurus cinereus</i>	LACI	Thawed
Adelaide Wind Farm	2015	19	Subset	Ken Edwards	No	3	9	9/3/2015	Fall	Anna Corrigan	7:20	n/a	Red Bat	<i>Lasiurus borealis</i>	LABO	Thawed
Adelaide Wind Farm	2015	6	Subset	Ken Edwards	No	10	9	9/10/2015	Fall	Sam Soehn	6:30	n/a	Bird	n/a	n/a	Thawed
Adelaide Wind Farm	2015	11	Subset	Ken Edwards	No	10	9	9/10/2015	Fall	Sam Soehn	6:41	Sept 14 @ 12:00pm	Bat	n/a	n/a	Thawed
Adelaide Wind Farm	2015	14	Subset	Ken Edwards	No	10	9	9/10/2015	Fall	Sam Soehn	6:50	n/a	Bird	n/a	n/a	Thawed
Adelaide Wind Farm	2015	27	Subset	Ken Edwards	No	14	9	9/14/2015	Fall	Anna Corrigan	7:15	n/a	American Robin	<i>Turdus migratorius</i>	AMRO	Thawed
Adelaide Wind Farm	2015	22	Subset	Ken Edwards	No	14	9	9/14/2015	Fall	Anna Corrigan	7:25	n/a	Hoary Bat	<i>Lasiurus cinereus</i>	LACI	Thawed

**Table F5: Searcher Efficiency Data**

Project_Name	Carcass_UTM_Zone	Carcass_Easting_nad83	Carcass_Northing_nad83	Distance_from_Turbine_m	Direction_from_Turbine	Marking	Temp	Wind_Speed	Cloud	Precip	Scavenged	Found	Placed	Substrate	Visibility_Class
Adelaide Wind Farm	17T	451973	4762608	4	W	Thread	12 to 16	3	10-20	None	0	1	1	Gravel	1
Adelaide Wind Farm	17T	444551	4765089	46	NE	Thread	12 to 16	3	10-20	None	0	1	1	Dirt/grass	2
Adelaide Wind Farm	17T	438306	4763190	21	S	Tag	12 to 16	3	10-20	None	0	1	1	Dirt	1
Adelaide Wind Farm	17T	449641	4762154	18	WNW	Orange Tape	1 to 3	3-5	10	None	0	0	1	Dirt	1
Adelaide Wind Farm	17T	447188	4764863	16	ENE	Orange Tape	1 to 3	3-5	10	None	0	1	1	Dirt	1
Adelaide Wind Farm	17T	449210	4763634	45	E	Orange Tape	13 to 15	2	10	None	0	1	1	Dirt	1
Adelaide Wind Farm	17T	447354	4763385	40	NW	Orange Tape	13 to 15	2	10	None	0	0	1	Weeds	2
Adelaide Wind Farm	17T	442953	4764964	25	SSE	Orange Tape	13 to 15	2	10	None	0	1	1	Gravel	1
Adelaide Wind Farm	17T	451984	4762608	5	E	Tape	7	11	20	None	0	1	1	Weeds	2
Adelaide Wind Farm	17T	449633	4762147	28	W	Tape	7	11	20	None	0	0	1	Gravel	1
Adelaide Wind Farm	17T	440264	4765196	31	S	Orange Tape	14	11	60	None	0	0	1	Dirt	1
Adelaide Wind Farm	17T	435963	4765492	24	N	Orange Tape	14	11	60	None	0	0	1	Dirt/Veg	2
Adelaide Wind Farm	17T	435978	4765452	20	SE	Orange Tape	14	11	60	None	1	0	1	Dirt	1
Adelaide Wind Farm	17T	451975	4762615	6	NW	Scotch Tape	20	5	100	None	0	1	1	Weeds/Crops	2
Adelaide Wind Farm	17T	447848	4763387	39	SW	Tag	20	5	100	None	1	0	1	Dirt/Weeds	2
Adelaide Wind Farm	17T	444539	4765096	39	NE	Scotch Tape	20	5	100	None	0	1	1	Dirt/Weeds	2
Adelaide Wind Farm	17T	442954	4764930	35	SE	Scotch Tape	19	1	10	None	0	1	1	Soy	1
Adelaide Wind Farm	17T	435959	4765466	6	W	Scotch Tape	19	1	10	None	1	0	1	Rocks under turbine	1
Adelaide Wind Farm	17T	449126	4763604	25	SW	Scotch Tape	15	3	90	None	0	0	1	Soy/Dirt	1
Adelaide Wind Farm	17T	447185	4764878	24	NE	Scotch Tape	15	3	90	None	0	0	1	Soy/Weeds	2
Adelaide Wind Farm	17T	438296	4763210	13	W	Scotch Tape	15	3	90	None	0	0	1	Corn	2
Adelaide Wind Farm	17T	449686	4762167	36	NE	Scotch Tape	13	3	50	None	0	1	1	Soy	2
Adelaide Wind Farm	17T	447130	4764856	40	W	Tag	13	3	50	None	0	1	1	Corn	2
Adelaide Wind Farm	17T	440259	4765237	13	NE	Scotch Tape	13	3	50	None	0	1	1	Dirt	1
Adelaide Wind Farm	17T	449172	4763600	33	SE	Scotch Tape	15	5	100	Light	0	1	1	Soy	1
Adelaide Wind Farm	17T	447911	4763356	35	SE	Tag	15	5	100	Light	1	0	1	Weeds	2
Adelaide Wind Farm	17T	444515	4765107	40	NE	Scotch Tape	15-16	1	5	None	1	0	1	Weeds	2
Adelaide Wind Farm	17T	438332	4763242	38	NE	Tag	15-16	1	5	None	0	1	1	Ploughed dirt	2
Adelaide Wind Farm	17T	435958	4765457	12	SW	Scotch Tape	15-16	1	5	None	0	0	1	Ploughed dirt	1
Adelaide Wind Farm	17T	449661	4762154	9	N	Orange Tape	13-16	1	20	None	0	1	1	Dirt	1
Adelaide Wind Farm	17T	451971	4762604	6	WSW	Paper clip	13-16	1	20	None	0	0	1	Weeds	2
Adelaide Wind Farm	17T	444508	4765055	8	S	Masking Tape	13-16	1	20	None	0	0	1	Weeds	2
Adelaide Wind Farm	17T	435969	4765470	5	WNW	Scotch Tape	16-17	5	15	None	0	1	1	Access Road	1
Adelaide Wind Farm	17T	447889	4763372	18	NE	Scotch Tape	16-17	5	15	None	0	0	1	Weeds/Dirt	2
Adelaide Wind Farm	17T	447199	4764854	27	E	Scotch Tape	14	2-3	40	None	0	0	1	Soy	2
Adelaide Wind Farm	17T	442946	4764954	13	SWS	Scotch Tape	14	2-3	40	None	0	1	1	Dirt	1
Adelaide Wind Farm	17T	440254	4765252	22	N	White String	14	2-3	40	None	0	1	1	Dirt	1
Adelaide Wind Farm	17T	451986	4762637	27	NE	Scotch Tape	11	3	25	None	0	0	1	Dirt/Soy	2
Adelaide Wind Farm	17T	449149	4763622	2	SE	Scotch Tape	11	3	25	None	0	1	1	Access Road	1
Adelaide Wind Farm	17T	438322	4763222	16	NE	Scotch Tape	11	3	25	None	0	1	1	Access Road	1
Adelaide Wind Farm	17T	449169	4763630	22	NE	Scotch Tape	20		100	Rain	0	1	1	Soy	2
Adelaide Wind Farm	17T	447862	4763349	15	SW	Scotch Tape	20		100	Rain	0	1	1	Access Road	1
Adelaide Wind Farm	17T	451970	4762628	24	N	Scotch Tape	20		100	Rain	0	1	1	Soy	2
Adelaide Wind Farm	17T	451987	4762591	20	SE	Orange Tape	13-14	7	95	Drizzle	0	1	1	dirt/weeds	2
Adelaide Wind Farm	17T	449150	4763624	0.5	N	Orange Tape	13-14	7	95	Drizzle	0	1	1	turbine base	1
Adelaide Wind Farm	17T	447166	4764827	24	S	Orange Tape	13-14	7	95	Drizzle	0	1	1	dirt/weeds	2
Adelaide Wind Farm	17T	447855	4763365	15	W	Clear Tape	21-22	2-6	100	Fog/Drizzle	0	0	1	Gravel	1
Adelaide Wind Farm	17T	444503	4765073	10	N	Orange Tape	21-22	2-6	100	Fog/Drizzle	0	1	1	Dirt/Weeds	2
Adelaide Wind Farm	17T	442985	4764956	42	E	Clear Tape	21-22	2-6	100	Fog/Drizzle	0	1	1	Dirt	1
Adelaide Wind Farm	17T	451980	4762595	16	E	Scotch Tape	10	1	25	None	1	0	1	Grass/dirt	2
Adelaide Wind Farm	17T	449151	4763624	2	NE	Scotch Tape	10	1	25	None	0	0	1	Access Road	1
Adelaide Wind Farm	17T	447158	4764846	11	SW	Scotch Tape	10	1	25	None	1	0	1	Access Road	1
Adelaide Wind Farm	17T	435989	4765457	23	SE	Orange Tape	9-10	5-8	20	None	0	1	1	Dirt	1
Adelaide Wind Farm	17T	438310	4763206	5	W	Pink Tape	9-10	5-8	20	None	0	1	1	Gravel	1

**Table F5: Searcher Efficiency Data**

Project_Name	Year	Turbine	Treatment_Group	Searcher_Name	Dog_Used	Day_Placed	Month_Placed	Date	Season	Placed_By	Time	Time_Collected	Species_Name_Common	Species_Name_Scientific	Species_Code	Condition
Adelaide Wind Farm	2015	12	Subset	Ken Edwards	No	14	9	9/14/2015	Fall	Anna Corrigan	7:45	16:00	White-throated Sparrow	<i>Zonotrichia albicollis</i>	WTSP	Thawed
Adelaide Wind Farm	2015	6	Subset	Ken Edwards	No	17	9	9/17/2015	Fall	Sam Soehn	6:31	n/a	Bird	n/a	n/a	Thawed
Adelaide Wind Farm	2015	7	Subset	Ken Edwards	No	17	9	9/17/2015	Fall	Sam Soehn	6:44	16:00	Hoary Bat	<i>Lasiurus cinereus</i>	LACI	Thawed
Adelaide Wind Farm	2015	14	Subset	Ken Edwards	No	17	9	9/17/2015	Fall	Sam Soehn	6:59	n/a	Hoary Bat	<i>Lasiurus cinereus</i>	LACI	Thawed
Adelaide Wind Farm	2015	7	Subset	Ken Edwards	No	21	9	9/21/2015	Fall	Anna Corrigan	7:10	16:30	White-throated Sparrow	<i>Zonotrichia albicollis</i>	WTSP	Thawed
Adelaide Wind Farm	2015	22	Subset	Ken Edwards	No	21	9	9/21/2015	Fall	Anna Corrigan	7:35	16:15	Hoary Bat	<i>Lasiurus cinereus</i>	LACI	Thawed
Adelaide Wind Farm	2015	27	Subset	Ken Edwards	No	21	9	9/21/2015	Fall	Anna Corrigan	7:45	n/a	Hoary Bat	<i>Lasiurus cinereus</i>	LACI	Thawed
Adelaide Wind Farm	2015	17	Subset	Ken Edwards	No	28	9	9/28/2015	Fall	Sam Soehn	8:00	n/a	Red Bat	<i>Lasiurus borealis</i>	LABO	Thawed
Adelaide Wind Farm	2015	19	Subset	Ken Edwards	No	28	9	9/28/2015	Fall	Sam Soehn	8:10	n/a	Bird	n/a	n/a	Thawed
Adelaide Wind Farm	2015	22	Subset	Ken Edwards	No	28	9	9/28/2015	Fall	Sam Soehn	8:22	n/a	Grouse	n/a	n/a	Thawed
Adelaide Wind Farm	2015	6	Subset	Ken Edwards	No	5	10	10/5/2015	Fall	Anna Corrigan	7:25	n/a	Baltimore Oriole	<i>Icterus galbula</i>	BAOR	Thawed
Adelaide Wind Farm	2015	11	Subset	Ken Edwards	No	5	10	10/5/2015	Fall	Anna Corrigan	7:45	16:30	Hoary Bat	<i>Lasiurus cinereus</i>	LACI	Thawed
Adelaide Wind Farm	2015	14	Subset	Ken Edwards	No	5	10	10/5/2015	Fall	Anna Corrigan	8:00	n/a	Killdeer	<i>Charadrius vociferus</i>	KILL	Thawed
Adelaide Wind Farm	2015	12	Subset	Ken Edwards	No	15	10	10/15/2015	Fall	Anna Corrigan	7:45	14:55	Hoary Bat	<i>Lasiurus cinereus</i>	LACI	Thawed
Adelaide Wind Farm	2015	22	Subset	Ken Edwards	No	15	10	10/15/2015	Fall	Anna Corrigan	8:15	n/a	Red-tailed Hawk	<i>Buteo jamaicensis</i>	RTHA	Thawed
Adelaide Wind Farm	2015	27	Subset	Ken Edwards	No	15	10	10/15/2015	Fall	Anna Corrigan	8:30	n/a	Tree Swallow	<i>Tachycineta bicolor</i>	TRES	Thawed
n/a	2015	5	n/a	Anna Corrigan	no	5	5	05/05/15	Spring	Sam Soehn	7:05	n/a	Bat	n/a	n/a	Frozen
n/a	2015	15	n/a	Anna Corrigan	no	5	5	05/05/15	Spring	Sam Soehn	7:25	n/a	Bird	n/a	n/a	Frozen
n/a	2015	8	n/a	Anna Corrigan	no	12	5	05/12/15	Spring	Sam Soehn	7:15	14:30	Bird	n/a	n/a	Thawed
n/a	2015	13	n/a	Anna Corrigan	no	12	5	05/12/15	Spring	Sam Soehn	7:35	n/a	Bat	n/a	n/a	Thawed
n/a	2015	3	n/a	Anna Corrigan	no	12	5	05/12/15	Spring	Sam Soehn	7:55	n/a	Bird	n/a	n/a	Thawed
n/a	2015	2	n/a	Anna Corrigan	no	15	5	05/15/15	Spring	Sam Soehn	6:45	n/a	Bird	n/a	n/a	Thawed
n/a	2015	6	n/a	Anna Corrigan	no	15	5	05/15/15	Spring	Sam Soehn	7:00	n/a	Bat	n/a	n/a	Thawed
n/a	2015	24	n/a	Anna Corrigan	no	15	5	05/15/15	Spring	Sam Soehn	7:30	n/a	Bird	n/a	n/a	Thawed
n/a	2015	5	n/a	Anna Corrigan	no	29	5	05/29/15	Spring	Sam Soehn	6:50	n/a	Bird	n/a	n/a	Thawed
n/a	2015	15	n/a	Anna Corrigan	no	29	5	05/29/15	Spring	Sam Soehn	7:05	n/a	Bat	n/a	n/a	Thawed
n/a	2015	25	n/a	Anna Corrigan	no	29	5	05/29/15	Spring	Sam Soehn	7:30	n/a	Bird	n/a	n/a	Thawed
n/a	2015	8	n/a	Anna Corrigan	no	5	6	06/05/15	Spring	Sam Soehn	6:13	n/a	Bird	n/a	n/a	Thawed
n/a	2015	2	n/a	Anna Corrigan	no	5	6	06/05/15	Spring	Sam Soehn	6:27	n/a	Bird	n/a	n/a	Thawed
n/a	2015	13	n/a	Anna Corrigan	no	5	6	06/05/15	Spring	Sam Soehn	6:45	n/a	Bat	n/a	n/a	Thawed
n/a	2015	6	n/a	Anna Corrigan	no	12	6	06/12/15	Spring	Sam Soehn	6:30	12:20	Hoary Bat	<i>Lasiurus cinereus</i>	LACI	Thawed
n/a	2015	3	n/a	Anna Corrigan	no	12	6	06/12/15	Spring	Sam Soehn	6:42	n/a	Hoary Bat	<i>Lasiurus cinereus</i>	LACI	Thawed
n/a	2015	15	n/a	Anna Corrigan	no	12	6	06/12/15	Spring	Sam Soehn	7:02	n/a	Bird	n/a	n/a	Thawed
n/a	2015	2	n/a	Anna Corrigan	no	19	6	06/19/15	Spring	Kristy Ramkissoon	7:30	n/a	Bird	n/a	n/a	Thawed
n/a	2015	6	n/a	Anna Corrigan	no	19	6	06/19/15	Spring	Kristy Ramkissoon	8:06	n/a	Eastern Red Bat	<i>Lasiurus borealis</i>	LABO	Thawed
n/a	2015	8	n/a	Anna Corrigan	no	19	6	06/19/15	Spring	Kristy Ramkissoon	8:17	n/a	Hoary Bat	<i>Lasiurus cinereus</i>	LACI	Thawed
n/a	2015	5	n/a	Anna Corrigan	no	30	6	06/30/15	Spring	Sam Soehn	7:00	n/a	Bat	n/a	n/a	Thawed
n/a	2015	8	n/a	Anna Corrigan	no	30	6	06/30/15	Spring	Sam Soehn	7:09	n/a	Bat	n/a	n/a	Thawed
n/a	2015	13	n/a	Anna Corrigan	no	30	6	06/30/15	Spring	Sam Soehn	7:31	n/a	Bird	n/a	n/a	Thawed
n/a	2015	2	n/a	Anna Corrigan	no	18	9	09/18/15	Fall	Sam Soehn	7:39	n/a	Hoary Bat	<i>Lasiurus cinereus</i>	LACI	Thawed
n/a	2015	6	n/a	Anna Corrigan	no	18	9	09/18/15	Fall	Sam Soehn	7:48	n/a	Bird	n/a	n/a	Thawed
n/a	2015	15	n/a	Anna Corrigan	no	18	9	09/18/15	Fall	Sam Soehn	8:03	n/a	Hoary Bat	<i>Lasiurus cinereus</i>	LACI	Thawed
n/a	2015	8	n/a	Anna Corrigan	no	22	9	09/22/15	Fall	Sam Soehn	7:20	n/a	Bird	n/a	n/a	Thawed
n/a	2015	5	n/a	Anna Corrigan	no	22	9	09/22/15	Fall	Sam Soehn	7:24	n/a	Hoary Bat	<i>Lasiurus cinereus</i>	LACI	Thawed
n/a	2015	13	n/a	Anna Corrigan	no	22	9	09/22/15	Fall	Sam Soehn	7:39	n/a	Bird	n/a	n/a	Thawed
n/a	2015	6	n/a	Anna Corrigan	no	25	9	09/25/15	Fall	Sam Soehn	6:41	n/a	Grouse	n/a	n/a	Thawed
n/a	2015	24	n/a	Anna Corrigan	no	25	9	09/25/15	Fall	Sam Soehn	7:02	n/a	Eastern Red Bat	<i>Lasiurus borealis</i>	LABO	Thawed
n/a	2015	23	n/a	Anna Corrigan	no	25	9	09/25/15	Fall	Sam Soehn	7:08	n/a	Bat	n/a	n/a	Thawed
n/a	2015	2	n/a	Anna Corrigan	no	29	9	09/29/15	Fall	Sam Soehn	6:32	12:00	Bird	n/a	n/a	Thawed
n/a	2015	5	n/a	Anna Corrigan	no	29	9	09/29/15	Fall	Sam Soehn	6:46	n/a	Bat	n/a	n/a	Thawed
n/a	2015	15	n/a	Anna Corrigan	no	29	9	09/29/15	Fall	Sam Soehn	7:02	n/a	Bat	n/a	n/a	Thawed

**Table F5: Searcher Efficiency Data**

Project_Name	Carcass_UTM_Zone	Carcass_Easting_nad83	Carcass_Northing_nad83	Distance_from_Turbine_m	Direction_from_Turbine	Marking	Temp	Wind_Speed	Cloud	Precip	Scavenged	Found	Placed	Substrate	Visibility_Class
Adelaide Wind Farm	17T	447835	4763358	46	W	Tag	9-10	5-8	20	None	0	0	1	Gravel	1
Adelaide Wind Farm	17T	451996	4762617	17	NE	Scotch Tape	14	1	100	Fog	0	1	1	Weeds/dirt	2
Adelaide Wind Farm	17T	449659	4762149	5	NE	Scotch Tape	14	1	100	Fog	0	0	1	Access Road	1
Adelaide Wind Farm	17T	447189	4764854	2	E	Scotch Tape	14	1	100	Fog	0	1	1	Soy/dirt	2
Adelaide Wind Farm	17T	449643	4762168	30	NW	Tag	7-10	13-15	60	None	0	0	1	Dirt	1
Adelaide Wind Farm	17T	438331	4763225	29	NE	Clear Tape	7-10	13-15	60	None	0	0	1	Dirt/Weeds	2
Adelaide Wind Farm	17T	435962	4765464	3	S	Clear Tape	7-10	13-15	60	None	0	1	1	Gravel	1
Adelaide Wind Farm	17T	444513	4765070	5	NE	Orange Tape	19	15	100	None	0	1	1	Access Road	1
Adelaide Wind Farm	17T	442936	4764972	16	NW	Tag	19	15	100	None	0	1	1	Dirt	1
Adelaide Wind Farm	17T	438316	4763188	21	SE	Scotch Tape	19	15	100	None	0	1	1	Weeds	2
Adelaide Wind Farm	17T	451992	4762614	21	NE	Orange Tape	11	1	90	None	0	1	1	Soy/dirt	1
Adelaide Wind Farm	17T	449156	4763606	16	SSE	Orange Tape	11	1	90	None	0	0	1	Soy/Dirt	2
Adelaide Wind Farm	17T	447170	4764861	9	N	Orange Tape	11	1	90	None	0	1	1	Grass/weeds	2
Adelaide Wind Farm	17T	447873	4763356	9	SSW	Orange Tape	7	8	30	None	0	0	1	Winter wheat	2
Adelaide Wind Farm	17T	438332	4763228	29	NE	Orange Tape	7	8	30	None	0	1	1	Dirt/weeds	2
Adelaide Wind Farm	17T	435956	4765466	7	W	Orange Tape	7	8	30	None	0	1	1	Dirt/weeds	2
n/a	17	552607	4867658	32	NW	Paper clip	10	5	E	None	0	1	1	Dirt	1
n/a	17	551407	4873487	40	SE	White sticker	10	5	E	None	0	1	1	Dirt	1
n/a	17	552581	4867995	17	NW	White sticker	12	25	SE	None	0	0	1	Weeds	2
n/a	17	551677	4872878	26	SE	Paper clip	12	25	SE	None	1	0	1	Ploughed Dirt	1
n/a	17	554471	4866999	27	E	Scotch Tape	12	25	SE	None	0	1	1	Grass	2
n/a	17	554829	4867051	26	SW	Scotch Tape	10	5	W	None	1	0	1	Grass	2
n/a	17	553214	4867847	35	SW	Scotch Tape	10	5	W	None	0	0	1	Ploughed Field	1
n/a	17	551233	4876197	28	W	White sticker	10	5	W	None	0	1	1	Access Road	1
n/a	17	552624	4867649	15	NW	White sticker	17	15	NW	None	0	1	1	Ploughed Dirt	1
n/a	17	551443	4873453	32	SE	Scotch Tape	17	15	NW	None	0	1	1	Grass/Weeds	2
n/a	17	551227	4875757	8	SW	Scotch Tape	17	15	NW	None	0	1	1	Grass/Weeds	2
n/a	17	552553	4867997	34	SW	Scotch Tape	16	5	NE	None	0	1	1	Dirt/ Weeds	2
n/a	17	554855	4867070	6	SE	White sticker	16	5	NE	None	0	1	1	Access Road	1
n/a	17	551658	4872878	28	NW	Scotch Tape	16	5	NE	None	0	1	1	Dirt/Grass	2
n/a	17	553216	4867864	19	SW	Scotch Tape	14	5	SW	Light	0	0	1	Ploughed dirt/ Soy	1
n/a	17	554430	4867011	9	E	Scotch Tape	14	5	SW	Light	0	1	1	Access Road	1
n/a	17	551442	4873460	23	S	Scotch Tape	14	5	SW	Light	0	1	1	Dirt/ Grass	2
n/a	17	551442	4873460	25	SW	Scotch Tape	12	13	NE	None	0	1	1	Access Road	1
n/a	17	553234	4867863	20	SE	Scotch Tape	12	13	NE	None	0	1	1	Gravel/Weeds	2
n/a	17	552389	4867963	15	N	Scotch Tape	12	13	NE	None	0	1	1	Gravel/Weeds	2
n/a	17	552632	4867665	15	NW	Scotch Tape	14	3	NW	None	0	1	1	Access Road	1
n/a	17	552569	4867988	18	NW	Scotch Tape	14	3	NW	None	0	1	1	Dirt/Weeds	2
n/a	17	551670	4872916	5	N	White sticker	14	3	NW	None	0	1	1	Access Road	1
n/a	17	554843	4867081	10	NE	Scotch Tape	15	10	NE	None	0	1	1	Dirt/ Grass	2
n/a	17	553238	4867871	8	SW	White sticker	15	10	NE	None	0	1	1	Access Road	1
n/a	17	551421	4873479	16	SW	Scotch Tape	15	10	NE	None	0	1	1	Dirt/ Weeds	2
n/a	17	552578	4867964	14	SW	White sticker	12	3	SW	Fog	1	0	1	Access Road	1
n/a	17	552638	4867651	3	WNW	Scotch Tape	12	3	SW	Fog	0	1	1	Weeds/Rocks	2
n/a	17	551667	4872906	4	WNW	White sticker	12	3	SW	Fog	0	1	1	Access Road	1
n/a	17	553240	4867869	33	SW	Scotch Tape	11	5	NW	None	0	1	1	Harvested hay	2
n/a	17	551205	4876193	2	SE	Orange tape	11	5	NW	None	0	1	1	Access Road/Weeds	2
n/a	17	551229	4875767	3	NW	Scotch Tape	11	5	NW	None	0	1	1	Access Road/Weeds	2
n/a	17	554861	4867051	12	NW	White sticker	18	10	SE	Fog	0	0	1	Grass	2
n/a	17	552642	4867663	2	E	Scotch Tape	18	10	SE	Fog	0	1	1	Access Road	1
n/a	17	551440	4873480	5	SE	Scotch Tape	18	10	SE	Fog	0	1	1	Access Road	1

**Table F6: 2015 Searcher Efficiency Summary**

Project Name	Treatment Group	Year	Season	Size Category	Month Start	Month End	Searcher Name	Number of Carcasses Placed	Number of Carcasses Scavenged	Number of Carcasses Found	Proportion Found	Proportion of Turbines Searched	Weighted Searcher Efficiency
Adelaide Wind Farm	Subset	2015	Spring	small-medium	5	6	Ken Edwards	24	3	13	61.90%	0.88125	0.545535714
Adelaide Wind Farm	Subset	2015	Summer	small-medium	7	8	Anna Corrigan	23	2	18	85.71%	0.11875	0.101785714
Adelaide Wind Farm	Subset	2015	Summer	small-medium	7	8	Ken Edwards	22	2	14	70.00%	1	0.7
Adelaide Wind Farm	Subset	2015	Fall	small-medium	9	10	Ken Edwards	24	2	14	63.64%	0.108280255	0.068905617
Adelaide Wind Farm	Subset	2015	Fall	small-medium	9	10	Anna Corrigan	12	1	10	90.91%	0.891719745	0.810654314

**F7: Scavenger Trial Data**

Project_Name	Year	Turbine_Number	Day_Placed	Season/Month	Month_Placed	Date	Species_Name_Common	Species_Name_Scientific	Species_Code	Condition	Carcass_UTM_Zone	Carcass_Easting_nad83
Adelaide Wind Farm	2015	7	3	Spring	5	5/3/2015	Silver-haired Bat	<i>Lasionycteris noctivagans</i>	LANO	Frozen	17T	449658
Adelaide Wind Farm	2015	12	3	Spring	5	5/3/2015	Bird (small)	n/a	n/a	Frozen	17T	447876
Adelaide Wind Farm	2015	17	3	Spring	5	5/3/2015	Bird (small)	n/a	n/a	Frozen	17T	444502
Adelaide Wind Farm	2015	20	3	Spring	5	5/3/2015	Hoary Bat	<i>Lasiurus cinereus</i>	LACI	Frozen	17T	440279
Adelaide Wind Farm	2015	27	3	Spring	5	5/3/2015	Bird (small)	n/a	n/a	Frozen	17T	435969
Adelaide Wind Farm	2015	6	21	Spring	5	5/21/2015	Bird (small)	n/a	n/a	Frozen	17T	451983
Adelaide Wind Farm	2015	11	21	Spring	5	5/21/2015	Hoary Bat	<i>Lasiurus cinereus</i>	LACI	Frozen	17T	449153
Adelaide Wind Farm	2015	14	21	Spring	5	5/21/2015	Bird (med)	n/a	n/a	Frozen	17T	447208
Adelaide Wind Farm	2015	19	21	Spring	5	5/21/2015	Silver-haired Bat	<i>Lasionycteris noctivagans</i>	LANO	Frozen	17T	442982
Adelaide Wind Farm	2015	22	21	Spring	5	5/21/2015	Bird (small)	n/a	n/a	Frozen	17T	438324
Adelaide Wind Farm	2015	11	3	Spring	6	6/3/2015	Bird (small)	n/a	n/a	Frozen	17T	449172
Adelaide Wind Farm	2015	12	3	Spring	6	6/3/2015	Hoary Bat	<i>Lasiurus cinereus</i>	LACI	Frozen	17T	447877
Adelaide Wind Farm	2015	17	3	Spring	6	6/3/2015	Bird (small)	n/a	n/a	Frozen	17T	444517
Adelaide Wind Farm	2015	20	3	Spring	6	6/3/2015	Silver-haired Bat	<i>Lasionycteris noctivagans</i>	LANO	Fresh	17T	440259
Adelaide Wind Farm	2015	27	3	Spring	6	6/3/2015	Hoary Bat	<i>Lasiurus cinereus</i>	LACI	Fresh	17T	435962
Adelaide Wind Farm	2015	6	17	Spring	6	6/17/2015	Horned Lark	<i>Eremophila alpestris</i>	HOLA	Frozen	17T	451977
Adelaide Wind Farm	2015	12	17	Spring	6	6/17/2015	Killdeer	<i>Charadrius vociferus</i>	KILL	Frozen	17T	447870
Adelaide Wind Farm	2015	14	17	Spring	6	6/17/2015	Big Brown Bat	<i>Eptesicus fuscus</i>	EPFU	Frozen	17T	447162
Adelaide Wind Farm	2015	19	17	Spring	6	6/17/2015	Bird (small)	n/a	n/a	Frozen	17T	442960
Adelaide Wind Farm	2015	22	17	Spring	6	6/17/2015	Big Brown Bat	<i>Eptesicus fuscus</i>	EPFU	Frozen	17T	438308
Adelaide Wind Farm	2015	6	5	Summer	7	7/5/2015	Bird (small)	n/a	n/a	Fresh	17T	451961
Adelaide Wind Farm	2015	11	5	Summer	7	7/5/2015	Bird (med)	n/a	n/a	Fresh	17T	449167
Adelaide Wind Farm	2015	14	5	Summer	7	7/5/2015	Hoary Bat	<i>Lasiurus cinereus</i>	LACI	Fresh	17T	447159
Adelaide Wind Farm	2015	19	5	Summer	7	7/5/2015	Bird (small)	n/a	n/a	Fresh	17T	442947
Adelaide Wind Farm	2015	27	5	Summer	7	7/5/2015	Bird (small)	n/a	n/a	Fresh	17T	436001
Adelaide Wind Farm	2015	6	19	Summer	7	7/19/2015	Bird (med)	n/a	n/a	Frozen	17T	442910
Adelaide Wind Farm	2015	7	19	Summer	7	7/19/2015	Bird (small)	n/a	n/a	Frozen	17T	449618
Adelaide Wind Farm	2015	12	19	Summer	7	7/19/2015	Hoary Bat	<i>Lasiurus cinereus</i>	LACI	Frozen	17T	447877
Adelaide Wind Farm	2015	19	19	Summer	7	7/19/2015	Mourning Dove	<i>Zenaida macroura</i>	MODO	Thawed	17T	442933
Adelaide Wind Farm	2015	22	19	Summer	7	7/19/2015	Bird (small)	n/a	n/a	Thawed	17T	448305
Adelaide Wind Farm	2015	27	6	Summer	8	8/6/2015	Bird (med)	n/a	n/a	Fresh	17T	447827
Adelaide Wind Farm	2015	22	6	Summer	8	8/6/2015	Bird (small)	n/a	n/a	Fresh	17T	438313
Adelaide Wind Farm	2015	19	6	Summer	8	8/6/2015	Hoary Bat	<i>Lasiurus cinereus</i>	LACI	Fresh	17T	442751
Adelaide Wind Farm	2015	14	6	Summer	8	8/6/2015	Bird (small)	n/a	n/a	Fresh	17T	447168
Adelaide Wind Farm	2015	6	6	Summer	8	8/6/2015	Bird (med)	n/a	n/a	Fresh	17T	451984
Adelaide Wind Farm	2015	7	19	Summer	8	8/19/2015	Bird (small)	n/a	n/a	Frozen	17T	449618
Adelaide Wind Farm	2015	11	19	Summer	8	8/19/2015	Bird (small)	n/a	n/a	Frozen	17T	449166
Adelaide Wind Farm	2015	17	19	Summer	8	8/19/2015	Bird (med)	n/a	n/a	Frozen	17T	444502
Adelaide Wind Farm	2015	19	19	Summer	8	8/19/2015	Red Bat	<i>Lasiurus borealis</i>	LABO	Frozen	17T	442938
Adelaide Wind Farm	2015	27	19	Summer	8	8/19/2015	Bird (small)	n/a	n/a	Frozen	17T	436011
Adelaide Wind Farm	2015	22	16	Fall	9	9/16/2015	Bird (med)	n/a	n/a	Fresh	17T	438337
Adelaide Wind Farm	2015	19	16	Fall	9	9/16/2015	Hoary Bat	<i>Lasiurus cinereus</i>	LACI	Fresh	17T	442956
Adelaide Wind Farm	2015	17	16	Fall	9	9/16/2015	Bird (med)	n/a	n/a	Fresh	17T	444504
Adelaide Wind Farm	2015	12	16	Fall	9	9/16/2015	Big Brown Bat	<i>Eptesicus fuscus</i>	EPFU	Fresh	17T	447832
Adelaide Wind Farm	2015	7	16	Fall	9	9/16/2015	Bird (med)	n/a	n/a	Fresh	17T	447832
Adelaide Wind Farm	2015	6	23	Fall	9	9/23/2015	Bird (small)	n/a	n/a	Fresh	17T	451964
Adelaide Wind Farm	2015	11	23	Fall	9	9/23/2015	Bird (med)	n/a	n/a	Fresh	17T	449161
Adelaide Wind Farm	2015	14	23	Fall	9	9/23/2015	Bird (small)	n/a	n/a	Fresh	17T	447173



**F7: Scavenger Trial Data**

Project_Name	Year	Turbine_Number	Carcass_Northing_nad83	Distance_from_Turbine_m	Direction_from_Turbine	Visibility_Class	Day_Visit1	Month_Visit1	Weather_Visit1	Scavenged_Visit1	Day_Visit2	Month_Visit2
Adelaide Wind Farm	2015	7	4762128	13	NE	1	4	5	Mild	no	7	5
Adelaide Wind Farm	2015	12	4763338	22	S	1	4	5	Mild	no	7	5
Adelaide Wind Farm	2015	17	4765063	7	W	1	4	5	Mild	no	7	5
Adelaide Wind Farm	2015	20	4765261	42	NNE	1	4	5	Mild	no	7	5
Adelaide Wind Farm	2015	27	4765947	19	SSE	1	4	5	Mild	no	7	5
Adelaide Wind Farm	2015	6	4762572	41	S	1	22	5	Cool/Sunny	no	25	5
Adelaide Wind Farm	2015	11	4763610	8	SE	1	22	5	Cool/Sunny	no	25	5
Adelaide Wind Farm	2015	14	4764888	45	ENE	1	22	5	Cool/Sunny	no	25	5
Adelaide Wind Farm	2015	19	4764971	30	E	1	22	5	Cool/Sunny	no	25	5
Adelaide Wind Farm	2015	22	4763187	22	SE	2	22	5	Cool/Sunny	no	25	5
Adelaide Wind Farm	2015	11	4763607	25	SE	1	4	6	Warm	no	8	6
Adelaide Wind Farm	2015	12	4763393	35	N	1	4	6	Warm	no	8	6
Adelaide Wind Farm	2015	17	4765037	30	SE	2	4	6	Warm	no	8	6
Adelaide Wind Farm	2015	20	4765240	10	N	1	4	6	Warm	no	8	6
Adelaide Wind Farm	2015	27	4765461	3	S	1	4	6	Warm	no	8	6
Adelaide Wind Farm	2015	6	4762624	14	NNW	1	18	6	Overcast	no	22	6
Adelaide Wind Farm	2015	12	4763346	13	SSW	2	18	6	Overcast	no	22	6
Adelaide Wind Farm	2015	14	4764800	46	SSE	1	18	6	Overcast	yes	22	6
Adelaide Wind Farm	2015	19	4764980	20	NE	1	18	6	Overcast	no	22	6
Adelaide Wind Farm	2015	22	4763241	34	N	1	18	6	Overcast	no	22	6
Adelaide Wind Farm	2015	6	4762601	14	WSW	1	6	7	Warm	yes	9	7
Adelaide Wind Farm	2015	11	4763637	22	NE	1	6	7	Warm	no	9	7
Adelaide Wind Farm	2015	14	4764814	38	SSW	1	6	7	Warm	no	9	7
Adelaide Wind Farm	2015	19	4764938	27	S	1	6	7	Warm	no	9	7
Adelaide Wind Farm	2015	27	4765471	33	E	2	6	7	Warm	no	9	7
Adelaide Wind Farm	2015	6	4764954	13	E	1	20	7	Warm	no	23	7
Adelaide Wind Farm	2015	7	4762128	45	SW	2	20	7	Warm	no	23	7
Adelaide Wind Farm	2015	12	4763373	7	ENE	1	20	7	Warm	no	23	7
Adelaide Wind Farm	2015	19	4764985	22	SW	1	20	7	Warm	no	23	7
Adelaide Wind Farm	2015	22	4763241	40	W	1	20	7	Warm	yes	23	7
Adelaide Wind Farm	2015	27	4763364	22	SE	1	7	8	Warm	no	10	8
Adelaide Wind Farm	2015	22	4763200	5	NE	1	7	8	Warm	no	10	8
Adelaide Wind Farm	2015	19	4764955	10	S	2	7	8	Warm	no	10	8
Adelaide Wind Farm	2015	14	4764807	43	S	1	7	8	Warm	no	10	8
Adelaide Wind Farm	2015	6	4762630	19	N	1	7	8	Warm	no	10	8
Adelaide Wind Farm	2015	7	4762151	45	W	1	20	8	Mild	no	24	8
Adelaide Wind Farm	2015	11	4763614	17	E	1	20	8	Mild	no	24	8
Adelaide Wind Farm	2015	17	4765069	3	W	1	20	8	Mild	no	24	8
Adelaide Wind Farm	2015	19	4764929	38	SW	2	20	8	Mild	no	24	8
Adelaide Wind Farm	2015	27	4765459	45	E	1	20	8	Mild	no	24	8
Adelaide Wind Farm	2015	22	4763202	25	E	2	17	9	Sunny	no	21	9
Adelaide Wind Farm	2015	19	4764959	15	SE	1	17	9	Sunny	no	21	9
Adelaide Wind Farm	2015	17	4765069	3	W	1	17	9	Sunny	no	21	9
Adelaide Wind Farm	2015	12	4763364	45	W	2	17	9	Sunny	no	21	9
Adelaide Wind Farm	2015	7	4763364	20	NW	1	17	9	Sunny	no	21	9
Adelaide Wind Farm	2015	6	4762567	40	S	2	24	9	Sunny	no	28	9
Adelaide Wind Farm	2015	11	4763603	20	SE	1	24	9	Sunny	yes	28	9
Adelaide Wind Farm	2015	14	4764843	5	SE	2	24	9	Sunny	no	28	9

**F7: Scavenger Trial Data**

Project_Name	Year	Turbine_Number	Weather_Visit2	Scavenged_Visit2	Day_Visit3	Month_Visit3	Weather_Visit3	Scavenged_Visit3	Day_Visit4	Month_Visit4	Weather_Visit4	Scavenged_Visit4
Adelaide Wind Farm	2015	7	Warm	no	11	5	Cloudy	yes	14	5	Cool	yes
Adelaide Wind Farm	2015	12	Warm	no	11	5	Cloudy	no	14	5	Cool	yes
Adelaide Wind Farm	2015	17	Warm	yes	11	5	Cloudy	yes	14	5	Cool	yes
Adelaide Wind Farm	2015	20	Warm	no	11	5	Cloudy	yes	14	5	Cool	yes
Adelaide Wind Farm	2015	27	Warm	yes	11	5	Cloudy	yes	14	5	Cool	yes
Adelaide Wind Farm	2015	6	Sunny	no	28	5	Sunny/Hot	yes	1	6	Mild	yes
Adelaide Wind Farm	2015	11	Sunny	no	28	5	Sunny/Hot	no	1	6	Mild	yes
Adelaide Wind Farm	2015	14	Sunny	no	28	5	Sunny/Hot	no	1	6	Mild	no
Adelaide Wind Farm	2015	19	Sunny	no	28	5	Sunny/Hot	no	1	6	Mild	no
Adelaide Wind Farm	2015	22	Sunny	no	28	5	Sunny/Hot	yes	1	6	Mild	yes
Adelaide Wind Farm	2015	11	Rain	no	11	6	Sunny/Warm	no	15	6	Cloudy/Hot	no
Adelaide Wind Farm	2015	12	Rain	no	11	6	Sunny/Warm	no	15	6	Sunny/Hot	no
Adelaide Wind Farm	2015	17	Rain	yes	11	6	Sunny/Warm	yes	15	6	Sunny/Hot	yes
Adelaide Wind Farm	2015	20	Rain	no	11	6	Sunny/Warm	no	15	6	Cloudy/Warm	no
Adelaide Wind Farm	2015	27	Rain	no	11	6	Sunny/Warm	yes	15	6	Cloudy/Warm	yes
Adelaide Wind Farm	2015	6	Warm	no	25	6	Overcast	no	29	6	Sunny	no
Adelaide Wind Farm	2015	12	Warm	no	25	6	Overcast	yes	29	6	Sunny	yes
Adelaide Wind Farm	2015	14	Warm	yes	25	6	Overcast	yes	29	6	Sunny	yes
Adelaide Wind Farm	2015	19	Warm	yes	25	6	Overcast	yes	29	6	Sunny	yes
Adelaide Wind Farm	2015	22	Warm	no	25	6	Overcast	no	29	6	Sunny	no
Adelaide Wind Farm	2015	6	Overcast	yes	13	7	Warm	yes	16	7	Warm	yes
Adelaide Wind Farm	2015	11	Overcast	no	13	7	Warm	yes	16	7	Warm	yes
Adelaide Wind Farm	2015	14	Overcast	no	13	7	Warm	no	16	7	Warm	no
Adelaide Wind Farm	2015	19	Overcast	no	13	7	Warm	yes	16	7	Warm	yes
Adelaide Wind Farm	2015	27	Overcast	no	13	7	Warm	no	16	7	Warm	no
Adelaide Wind Farm	2015	6	Warm	no	27	7	Hot	no	30	7	Hot	yes
Adelaide Wind Farm	2015	7	Warm	no	27	7	Hot	no	30	7	Hot	no
Adelaide Wind Farm	2015	12	Warm	yes	27	7	Hot	yes	30	7	Hot	yes
Adelaide Wind Farm	2015	19	Warm	no	27	7	Hot	no	30	7	Hot	no
Adelaide Wind Farm	2015	22	Warm	yes	27	7	Hot	yes	30	7	Hot	yes
Adelaide Wind Farm	2015	27	Rain/Overcast	no	13	8	Warm	no	17	8	Hot	no
Adelaide Wind Farm	2015	22	Rain/Overcast	no	13	8	Warm	no	17	8	Hot	yes
Adelaide Wind Farm	2015	19	Rain/Overcast	no	13	8	Warm	no	17	8	Hot	no
Adelaide Wind Farm	2015	14	Rain/Overcast	no	13	8	Warm	yes	17	8	Hot	yes
Adelaide Wind Farm	2015	6	Rain/Overcast	no	13	8	Warm	yes	17	8	Hot	yes
Adelaide Wind Farm	2015	7	Mild	no	27	8	Mild	no	31	8	Warm	no
Adelaide Wind Farm	2015	11	Mild	yes	27	8	Mild	yes	31	8	Warm	yes
Adelaide Wind Farm	2015	17	Mild	yes	27	8	Mild	yes	31	8	Warm	yes
Adelaide Wind Farm	2015	19	Mild	no	27	8	Mild	yes	31	8	Warm	yes
Adelaide Wind Farm	2015	27	Mild	no	27	8	Mild	yes	31	8	Warm	yes
Adelaide Wind Farm	2015	22	Sunny	yes	24	9	Sunny	yes	28	9	Mild	yes
Adelaide Wind Farm	2015	19	Sunny	yes	24	9	Sunny	yes	28	9	Mild	yes
Adelaide Wind Farm	2015	17	Sunny	no	24	9	Sunny	no	28	9	Mild	no
Adelaide Wind Farm	2015	12	Sunny	yes	24	9	Sunny	yes	28	9	Mild	yes
Adelaide Wind Farm	2015	7	Sunny	yes	24	9	Sunny	yes	28	9	Mild	yes
Adelaide Wind Farm	2015	6	Cloudy	no	1	10	Cold/clear	yes	5	10	Mild	yes
Adelaide Wind Farm	2015	11	Cloudy	yes	1	10	Cold/clear	yes	5	10	Mild	yes
Adelaide Wind Farm	2015	14	Cloudy	no	1	10	Cold/clear	no	5	10	Mild	no

**F7: Scavenger Trial Data**

Project_Name	Year	Turbine_Number	Day_Placed	Season/Month	Month_Placed	Date	Species_Name_Common	Species_Name_Scientific	Species_Code	Condition	Carcass_UTM_Zone	Carcass_Easting_nad83
Adelaide Wind Farm	2015	20	23	Fall	9	9/23/2015	Hoary Bat	<i>Lasiurus cinereus</i>	LACI	Fresh	17T	440236
Adelaide Wind Farm	2015	27	23	Fall	9	9/23/2015	Bird (med)	<i>n/a</i>	n/a	Fresh	17T	435993
Adelaide Wind Farm	2015	6	30	Fall	9	9/30/2015	Bird (small)	<i>n/a</i>	n/a	Frozen	17T	451984
Adelaide Wind Farm	2015	12	30	Fall	9	9/30/2015	Silver-haired Bat	<i>Lasionycteris noctivagans</i>	LANO	Frozen	17T	447837
Adelaide Wind Farm	2015	17	30	Fall	9	9/30/2015	Bird (small)	<i>n/a</i>	n/a	Frozen	17T	444508
Adelaide Wind Farm	2015	19	30	Fall	9	9/30/2015	Bird (small)	<i>n/a</i>	n/a	Frozen	17T	442959
Adelaide Wind Farm	2015	22	30	Fall	9	9/30/2015	Bird (med)	<i>n/a</i>	n/a	Frozen	17T	438322
Adelaide Wind Farm	2015	27	7	Fall	10	10/7/2015	Bird (small)	<i>n/a</i>	n/a	Fresh	17T	435962
Adelaide Wind Farm	2015	20	7	Fall	10	10/7/2015	Bird (small)	<i>n/a</i>	n/a	Fresh	17T	440237
Adelaide Wind Farm	2015	14	7	Fall	10	10/7/2015	Bird (small)	<i>n/a</i>	n/a	Fresh	17T	447175
Adelaide Wind Farm	2015	11	7	Fall	10	10/7/2015	Bird (small)	<i>n/a</i>	n/a	Fresh	17T	449151
Adelaide Wind Farm	2015	7	7	Fall	10	10/7/2015	Bird (small)	<i>n/a</i>	n/a	Fresh	17T	449644

**F7: Scavenger Trial Data**

Project_Name	Year	Turbine_Number	Carcass_Northing_nad83	Distance_from_Turbine_m	Direction_from_Turbine	Visibility_Class	Day_Visit1	Month_Visit1	Weather_Visit1	Scavenged_Visit1	Day_Visit2	Month_Visit2
Adelaide Wind Farm	2015	20	4765226	15	NW	1	24	9	Sunny	no	28	9
Adelaide Wind Farm	2015	27	4765498	30	E	2	24	9	Sunny	no	28	9
Adelaide Wind Farm	2015	6	4762590	16	SW	1	1	10	Cold/clear	no	5	10
Adelaide Wind Farm	2015	12	4763363	40	NW	2	1	10	Cold/clear	no	5	10
Adelaide Wind Farm	2015	17	4765060	3	S	2	1	10	Cold/clear	no	5	10
Adelaide Wind Farm	2015	19	4764968	35	E	1	1	10	Cold/clear	no	5	10
Adelaide Wind Farm	2015	22	4763231	25	NE	2	1	10	Cold/clear	no	5	10
Adelaide Wind Farm	2015	27	4765461	5	S	2	8	10	Sunny	no	12	10
Adelaide Wind Farm	2015	20	4765222	22	W	1	8	10	Sunny	no	12	10
Adelaide Wind Farm	2015	14	4764815	37	S	1	8	10	Sunny	no	12	10
Adelaide Wind Farm	2015	11	4763627	10	NE	2	8	10	Sunny	no	12	10
Adelaide Wind Farm	2015	7	4762156	20	NW	1	8	10	Sunny	no	12	10

**F7: Scavenger Trial Data**

Project_Name	Year	Turbine_Number	Weather_Visit2	Scavenged_Visit2	Day_Visit3	Month_Visit3	Weather_Visit3	Scavenged_Visit3	Day_Visit4	Month_Visit4	Weather_Visit4	Scavenged_Visit4
Adelaide Wind Farm	2015	20	Cloudy	no	1	10	Cold/clear	no	5	10	Mild	no
Adelaide Wind Farm	2015	27	Cloudy	yes	1	10	Cold/clear	yes	5	10	Mild	yes
Adelaide Wind Farm	2015	6	Overcast	no	8	10	Sunny	no	12	10	Sunny	no
Adelaide Wind Farm	2015	12	Overcast	yes	8	10	Sunny	yes	12	10	Sunny	yes
Adelaide Wind Farm	2015	17	Overcast	yes	8	10	Sunny	yes	12	10	Sunny	yes
Adelaide Wind Farm	2015	19	Overcast	yes	8	10	Sunny	yes	12	10	Sunny	yes
Adelaide Wind Farm	2015	22	Overcast	no	8	10	Sunny	yes	12	10	Sunny	yes
Adelaide Wind Farm	2015	27	Cloudy	no	15	10	Clear	no	19	10	Clear	yes
Adelaide Wind Farm	2015	20	Sunny	no	15	10	Clear	no	19	10	Clear	no
Adelaide Wind Farm	2015	14	Sunny	no	15	10	Clear	no	19	10	Clear	no
Adelaide Wind Farm	2015	11	Sunny	no	15	10	Clear	yes	19	10	Clear	yes
Adelaide Wind Farm	2015	7	Sunny	yes	15	10	Clear	yes	19	10	Clear	yes

**Table F8: Scavenger Trial Summary**

Project Name	Treatment Group	Year	Season	Month	Month Start	Month End	Size Category	Turbine Number	Number of Carcasses Placed N0	Number of Carcasses Left N1	Number of Carcasses Left N2	Number of Carcasses Left N3	Number of Carcasses Left N4	Scavenger Correction Sc
Adelaide Wind Farm	Subset	2015	Spring	May	5	6	Small-Medium	7	1	1	1	0	0	0.66666667
Adelaide Wind Farm	Subset	2015	Spring	May	5	6	Small-Medium	12	1	1	1	1	0	0.75
Adelaide Wind Farm	Subset	2015	Spring	May	5	6	Small-Medium	17	1	1	0	0	0	0.5
Adelaide Wind Farm	Subset	2015	Spring	May	5	6	Small-Medium	20	1	1	1	0	0	0.66666667
Adelaide Wind Farm	Subset	2015	Spring	May	5	6	Small-Medium	27	1	1	0	0	0	0.5
Adelaide Wind Farm	Subset	2015	Spring	May	5	6	Small-Medium	6	1	1	1	0	0	0.66666667
Adelaide Wind Farm	Subset	2015	Spring	May	5	6	Small-Medium	11	1	1	1	1	0	0.75
Adelaide Wind Farm	Subset	2015	Spring	May	5	6	Small-Medium	14	1	1	1	1	1	1
Adelaide Wind Farm	Subset	2015	Spring	May	5	6	Small-Medium	19	1	1	1	1	1	1
Adelaide Wind Farm	Subset	2015	Spring	May	5	6	Small-Medium	22	1	1	1	0	0	0.66666667
Adelaide Wind Farm	Subset	2015	Spring	June	5	6	Small-Medium	11	1	1	1	1	1	1
Adelaide Wind Farm	Subset	2015	Spring	June	5	6	Small-Medium	12	1	1	1	1	1	1
Adelaide Wind Farm	Subset	2015	Spring	June	5	6	Small-Medium	17	1	1	0	0	0	0.5
Adelaide Wind Farm	Subset	2015	Spring	June	5	6	Small-Medium	20	1	1	1	1	1	1
Adelaide Wind Farm	Subset	2015	Spring	June	5	6	Small-Medium	27	1	1	1	0	0	0.66666667
Adelaide Wind Farm	Subset	2015	Spring	June	5	6	Small-Medium	6	1	1	1	1	1	1
Adelaide Wind Farm	Subset	2015	Spring	June	5	6	Small-Medium	12	1	1	1	0	0	0.66666667
Adelaide Wind Farm	Subset	2015	Spring	June	5	6	Small-Medium	14	1	0	0	0	0	0
Adelaide Wind Farm	Subset	2015	Spring	June	5	6	Small-Medium	19	1	1	0	0	0	0.5
Adelaide Wind Farm	Subset	2015	Spring	June	5	6	Small-Medium	22	1	1	1	1	1	1
Adelaide Wind Farm	Subset	2015	Summer	July	7	8	Small-Medium	6	1	0	0	0	0	0

**Table F8: Scavenger Trial Summary**

Project Name	Treatment Group	Year	Season	Month	Month Start	Month End	Size Category	Turbine Number	Number of Carcasses Placed N0	Number of Carcasses Left N1	Number of Carcasses Left N2	Number of Carcasses Left N3	Number of Carcasses Left N4	Scavenger Correction Sc
Adelaide Wind Farm	Subset	2015	Summer	July	7	8	Small-Medium	11	1	1	1	0	0	0.66666667
Adelaide Wind Farm	Subset	2015	Summer	July	7	8	Small-Medium	14	1	1	1	1	1	1
Adelaide Wind Farm	Subset	2015	Summer	July	7	8	Small-Medium	19	1	1	1	0	0	0.66666667
Adelaide Wind Farm	Subset	2015	Summer	July	7	8	Small-Medium	27	1	1	1	1	1	1
Adelaide Wind Farm	Subset	2015	Summer	July	7	8	Small-Medium	6	1	1	1	1	0	0.75
Adelaide Wind Farm	Subset	2015	Summer	July	7	8	Small-Medium	7	1	1	1	1	1	1
Adelaide Wind Farm	Subset	2015	Summer	July	7	8	Small-Medium	12	1	1	0	0	0	0.5
Adelaide Wind Farm	Subset	2015	Summer	July	7	8	Small-Medium	19	1	1	1	1	1	1
Adelaide Wind Farm	Subset	2015	Summer	July	7	8	Small-Medium	22	1	0	0	0	0	0
Adelaide Wind Farm	Subset	2015	Summer	August	7	8	Small-Medium	27	1	1	1	1	1	1
Adelaide Wind Farm	Subset	2015	Summer	August	7	8	Small-Medium	22	1	1	1	1	0	0.75
Adelaide Wind Farm	Subset	2015	Summer	August	7	8	Small-Medium	19	1	1	1	1	1	1
Adelaide Wind Farm	Subset	2015	Summer	August	7	8	Small-Medium	14	1	1	1	0	0	0.66666667
Adelaide Wind Farm	Subset	2015	Summer	August	7	8	Small-Medium	6	1	1	1	0	0	0.66666667
Adelaide Wind Farm	Subset	2015	Summer	August	7	8	Small-Medium	7	1	1	1	1	1	1
Adelaide Wind Farm	Subset	2015	Summer	August	7	8	Small-Medium	11	1	1	0	0	0	0.5
Adelaide Wind Farm	Subset	2015	Summer	August	7	8	Small-Medium	17	1	1	0	0	0	0.5
Adelaide Wind Farm	Subset	2015	Summer	August	7	8	Small-Medium	19	1	1	1	0	0	0.66666667
Adelaide Wind Farm	Subset	2015	Summer	August	7	8	Small-Medium	27	1	1	1	0	0	0.66666667
Adelaide Wind Farm	Subset	2015	Fall	September	9	10	Small-Medium	22	1	1	0	0	0	0.5
Adelaide Wind Farm	Subset	2015	Fall	September	9	10	Small-Medium	19	1	1	0	0	0	0.5

**Table F8: Scavenger Trial Summary**

Project Name	Treatment Group	Year	Season	Month	Month Start	Month End	Size Category	Turbine Number	Number of Carcasses Placed N0	Number of Carcasses Left N1	Number of Carcasses Left N2	Number of Carcasses Left N3	Number of Carcasses Left N4	Scavenger Correction Sc
Adelaide Wind Farm	Subset	2015	Fall	September	9	10	Small-Medium	17	1	1	1	1	1	1
Adelaide Wind Farm	Subset	2015	Fall	September	9	10	Small-Medium	12	1	1	0	0	0	0.5
Adelaide Wind Farm	Subset	2015	Fall	September	9	10	Small-Medium	7	1	1	0	0	0	0.5
Adelaide Wind Farm	Subset	2015	Fall	September	9	10	Small-Medium	6	1	1	1	0	0	0.66666667
Adelaide Wind Farm	Subset	2015	Fall	September	9	10	Small-Medium	11	1	0	0	0	0	0
Adelaide Wind Farm	Subset	2015	Fall	September	9	10	Small-Medium	14	1	1	1	1	1	1
Adelaide Wind Farm	Subset	2015	Fall	September	9	10	Small-Medium	20	1	1	1	1	1	1
Adelaide Wind Farm	Subset	2015	Fall	September	9	10	Small-Medium	27	1	1	0	0	0	0.5
Adelaide Wind Farm	Subset	2015	Fall	September	9	10	Small-Medium	6	1	1	1	1	1	1
Adelaide Wind Farm	Subset	2015	Fall	September	9	10	Small-Medium	12	1	1	0	0	0	0.5
Adelaide Wind Farm	Subset	2015	Fall	September	9	10	Small-Medium	17	1	1	0	0	0	0.5
Adelaide Wind Farm	Subset	2015	Fall	September	9	10	Small-Medium	19	1	1	0	0	0	0.5
Adelaide Wind Farm	Subset	2015	Fall	September	9	10	Small-Medium	22	1	1	1	0	0	0.66666667
Adelaide Wind Farm	Subset	2015	Fall	October	9	10	Small-Medium	27	1	1	1	1	0	0.75
Adelaide Wind Farm	Subset	2015	Fall	October	9	10	Small-Medium	20	1	1	1	1	1	1
Adelaide Wind Farm	Subset	2015	Fall	October	9	10	Small-Medium	14	1	1	1	1	1	1
Adelaide Wind Farm	Subset	2015	Fall	October	9	10	Small-Medium	11	1	1	1	0	0	0.66666667
Adelaide Wind Farm	Subset	2015	Fall	October	9	10	Small-Medium	7	1	1	0	0	0	0.5



**Table F9: Percent Area Searched Data**

Project Name	Turbine Number	Date	Actual Area Searched M2	Actual Searched Capped M2	Total Area for Survey
Adelaide Wind Farm	7	5/4/2015	7854	7854	7854
Adelaide Wind Farm	11	5/4/2015	7854	7854	7854
Adelaide Wind Farm	12	5/4/2015	7854	7854	7854
Adelaide Wind Farm	17	5/4/2015	7854	7854	7854
Adelaide Wind Farm	19	5/4/2015	7854	7854	7854
Adelaide Wind Farm	20	5/4/2015	7854	7854	7854
Adelaide Wind Farm	22	5/4/2015	7854	7854	7854
Adelaide Wind Farm	27	5/4/2015	7854	7854	7854
Adelaide Wind Farm	14	5/4/2015	7854	7854	7854
Adelaide Wind Farm	6	5/4/2015	7854	7854	7854
Adelaide Wind Farm	7	5/7/2015	7854	7854	7854
Adelaide Wind Farm	12	5/7/2015	7854	7854	7854
Adelaide Wind Farm	14	5/7/2015	7854	7854	7854
Adelaide Wind Farm	17	5/7/2015	7854	7854	7854
Adelaide Wind Farm	19	5/7/2015	7854	7854	7854
Adelaide Wind	20	5/7/2015	7854	7854	7854

**Table F9: Percent Area Searched Data**

Project Name	Turbine Number	Date	Actual Area Searched M2	Actual Searched Capped M2	Total Area for Survey
Farm					
Adelaide Wind Farm	22	5/7/2015	7854	7854	7854
Adelaide Wind Farm	27	5/7/2015	7854	7854	7854
Adelaide Wind Farm	11	5/7/2015	7854	7854	7854
Adelaide Wind Farm	6	5/7/2015	7854	7854	7854
Adelaide Wind Farm	6	5/11/2015	7854	7854	7854
Adelaide Wind Farm	7	5/11/2015	7854	7854	7854
Adelaide Wind Farm	11	5/11/2015	7854	7854	7854
Adelaide Wind Farm	12	5/11/2015	7854	7854	7854
Adelaide Wind Farm	14	5/11/2015	7854	7854	7854
Adelaide Wind Farm	17	5/11/2015	7854	7854	7854
Adelaide Wind Farm	19	5/11/2015	7854	7854	7854
Adelaide Wind Farm	20	5/11/2015	7854	7854	7854
Adelaide Wind Farm	22	5/11/2015	7854	7854	7854
Adelaide Wind Farm	27	5/11/2015	7854	7854	7854
Adelaide Wind Farm	6	5/14/2015	7854	7854	7854

**Table F9: Percent Area Searched Data**

Project Name	Turbine Number	Date	Actual Area Searched M2	Actual Searched Capped M2	Total Area for Survey
Adelaide Wind Farm	7	5/14/2015	7854	7854	7854
Adelaide Wind Farm	12	5/14/2015	7854	7854	7854
Adelaide Wind Farm	14	5/14/2015	7854	7854	7854
Adelaide Wind Farm	17	5/14/2015	7854	7854	7854
Adelaide Wind Farm	20	5/14/2015	7854	7854	7854
Adelaide Wind Farm	22	5/14/2015	7854	7854	7854
Adelaide Wind Farm	27	5/14/2015	7854	7854	7854
Adelaide Wind Farm	6	5/19/2015	7854	7854	7854
Adelaide Wind Farm	7	5/19/2015	7854	7854	7854
Adelaide Wind Farm	11	5/19/2015	7854	7854	7854
Adelaide Wind Farm	12	5/19/2015	7854	7854	7854
Adelaide Wind Farm	14	5/19/2015	7854	7854	7854
Adelaide Wind Farm	17	5/19/2015	7854	7854	7854
Adelaide Wind Farm	20	5/19/2015	7854	7854	7854
Adelaide Wind Farm	22	5/19/2015	7854	7854	7854
Adelaide Wind	27	5/19/2015	7854	7854	7854

**Table F9: Percent Area Searched Data**

Project Name	Turbine Number	Date	Actual Area Searched M2	Actual Searched Capped M2	Total Area for Survey
Farm					
Adelaide Wind Farm	19	5/19/2015	7854	7854	7854
Adelaide Wind Farm	6	5/22/2015	7854	7854	7854
Adelaide Wind Farm	7	5/22/2015	7854	7854	7854
Adelaide Wind Farm	11	5/22/2015	7854	7854	7854
Adelaide Wind Farm	12	5/22/2015	7854	7854	7854
Adelaide Wind Farm	14	5/22/2015	7854	7854	7854
Adelaide Wind Farm	17	5/22/2015	7854	7854	7854
Adelaide Wind Farm	20	5/22/2015	7854	7854	7854
Adelaide Wind Farm	22	5/22/2015	7854	7854	7854
Adelaide Wind Farm	27	5/22/2015	7854	7854	7854
Adelaide Wind Farm	19	5/22/2015	7854	7854	7854
Adelaide Wind Farm	6	5/25/2015	7854	7854	7854
Adelaide Wind Farm	7	5/25/2015	7854	7854	7854
Adelaide Wind Farm	11	5/25/2015	7854	7854	7854
Adelaide Wind Farm	12	5/25/2015	7854	7854	7854

**Table F9: Percent Area Searched Data**

Project Name	Turbine Number	Date	Actual Area Searched M2	Actual Searched Capped M2	Total Area for Survey
Adelaide Wind Farm	14	5/25/2015	7854	7854	7854
Adelaide Wind Farm	17	5/25/2015	7854	7854	7854
Adelaide Wind Farm	22	5/25/2015	7854	7854	7854
Adelaide Wind Farm	27	5/25/2015	7854	7854	7854
Adelaide Wind Farm	20	5/25/2015	7854	7854	7854
Adelaide Wind Farm	19	5/25/2015	7854	7854	7854
Adelaide Wind Farm	6	5/28/2015	7854	7854	7854
Adelaide Wind Farm	7	5/28/2015	7854	7854	7854
Adelaide Wind Farm	11	5/28/2015	7854	7854	7854
Adelaide Wind Farm	12	5/28/2015	7854	7854	7854
Adelaide Wind Farm	14	5/28/2015	7854	7854	7854
Adelaide Wind Farm	17	5/28/2015	3992	3992	7854
Adelaide Wind Farm	19	5/28/2015	7854	7854	7854
Adelaide Wind Farm	20	5/28/2015	7854	7854	7854
Adelaide Wind Farm	22	5/28/2015	7854	7854	7854
Adelaide Wind	27	5/28/2015	7854	7854	7854

**Table F9: Percent Area Searched Data**

Project Name	Turbine Number	Date	Actual Area Searched M2	Actual Searched Capped M2	Total Area for Survey
Farm					
Adelaide Wind Farm	6	6/1/2015	7854	7854	7854
Adelaide Wind Farm	11	6/1/2015	7854	7854	7854
Adelaide Wind Farm	14	6/1/2015	7854	7854	7854
Adelaide Wind Farm	17	6/1/2015	3992	3992	7854
Adelaide Wind Farm	19	6/1/2015	7854	7854	7854
Adelaide Wind Farm	20	6/1/2015	7854	7854	7854
Adelaide Wind Farm	22	6/1/2015	7854	7854	7854
Adelaide Wind Farm	27	6/1/2015	7854	7854	7854
Adelaide Wind Farm	12	6/1/2015	7854	7854	7854
Adelaide Wind Farm	7	6/1/2015	7854	7854	7854
Adelaide Wind Farm	6	6/4/2015	4347	4347	7854
Adelaide Wind Farm	7	6/4/2015	6939	6939	7854
Adelaide Wind Farm	11	6/4/2015	7854	7854	7854
Adelaide Wind Farm	12	6/4/2015	7854	7854	7854
Adelaide Wind Farm	14	6/4/2015	7854	7854	7854

**Table F9: Percent Area Searched Data**

Project Name	Turbine Number	Date	Actual Area Searched M2	Actual Searched Capped M2	Total Area for Survey
Adelaide Wind Farm	17	6/4/2015	3992	3992	7854
Adelaide Wind Farm	19	6/4/2015	7854	7854	7854
Adelaide Wind Farm	20	6/4/2015	7854	7854	7854
Adelaide Wind Farm	22	6/4/2015	7695	7695	7854
Adelaide Wind Farm	27	6/4/2015	7854	7854	7854
Adelaide Wind Farm	6	6/8/2015	4347	4347	7854
Adelaide Wind Farm	7	6/8/2015	7854	7854	7854
Adelaide Wind Farm	11	6/8/2015	7854	7854	7854
Adelaide Wind Farm	12	6/8/2015	7854	7854	7854
Adelaide Wind Farm	14	6/8/2015	7854	7854	7854
Adelaide Wind Farm	17	6/8/2015	3992	3992	7854
Adelaide Wind Farm	19	6/8/2015	7854	7854	7854
Adelaide Wind Farm	20	6/8/2015	7854	7854	7854
Adelaide Wind Farm	22	6/8/2015	7695	7695	7854
Adelaide Wind Farm	7	6/11/2015	6939	6939	7854
Adelaide Wind	6	6/11/2015	4347	4347	7854

**Table F9: Percent Area Searched Data**

Project Name	Turbine Number	Date	Actual Area Searched M2	Actual Searched Capped M2	Total Area for Survey
Farm					
Adelaide Wind Farm	11	6/11/2015	7854	7854	7854
Adelaide Wind Farm	12	6/11/2015	7854	7854	7854
Adelaide Wind Farm	14	6/11/2015	7854	7854	7854
Adelaide Wind Farm	17	6/11/2015	3992	3992	7854
Adelaide Wind Farm	19	6/11/2015	7854	7854	7854
Adelaide Wind Farm	20	6/11/2015	7854	7854	7854
Adelaide Wind Farm	22	6/11/2015	7695	7695	7854
Adelaide Wind Farm	27	6/11/2015	7854	7854	7854
Adelaide Wind Farm	27	6/15/2015	7854	7854	7854
Adelaide Wind Farm	20	6/15/2015	7854	7854	7854
Adelaide Wind Farm	19	6/15/2015	7854	7854	7854
Adelaide Wind Farm	17	6/15/2015	3992	3992	7854
Adelaide Wind Farm	14	6/15/2015	7854	7854	7854
Adelaide Wind Farm	12	6/15/2015	7854	7854	7854
Adelaide Wind Farm	7	6/15/2015	6939	6939	7854



**Table F9: Percent Area Searched Data**

Project Name	Turbine Number	Date	Actual Area Searched M2	Actual Searched Capped M2	Total Area for Survey
Adelaide Wind Farm	6	6/15/2015	4347	4347	7854
Adelaide Wind Farm	11	6/15/2015	7854	7854	7854
Adelaide Wind Farm	27	6/18/2015	7854	7854	7854
Adelaide Wind Farm	22	6/18/2015	4701	4701	7854
Adelaide Wind Farm	20	6/18/2015	7854	7854	7854
Adelaide Wind Farm	19	6/18/2015	7854	7854	7854
Adelaide Wind Farm	17	6/18/2015	2638	2638	7854
Adelaide Wind Farm	14	6/18/2015	7854	7854	7854
Adelaide Wind Farm	12	6/18/2015	6821	6821	7854
Adelaide Wind Farm	11	6/18/2015	7854	7854	7854
Adelaide Wind Farm	7	6/18/2015	7432	7432	7854
Adelaide Wind Farm	6	6/18/2015	3423	3423	7854
Adelaide Wind Farm	27	6/22/2015	7854	7854	7854
Adelaide Wind Farm	22	6/22/2015	4701	4701	7854
Adelaide Wind Farm	20	6/22/2015	7854	7854	7854
Adelaide Wind	19	6/22/2015	7854	7854	7854

**Table F9: Percent Area Searched Data**

Project Name	Turbine Number	Date	Actual Area Searched M2	Actual Searched Capped M2	Total Area for Survey
Farm					
Adelaide Wind Farm	17	6/22/2015	2638	2638	7854
Adelaide Wind Farm	12	6/22/2015	6821	6821	7854
Adelaide Wind Farm	6	6/22/2015	3423	3423	7854
Adelaide Wind Farm	6	6/25/2015	3423	3423	7854
Adelaide Wind Farm	7	6/25/2015	7854	7854	7854
Adelaide Wind Farm	11	6/25/2015	7854	7854	7854
Adelaide Wind Farm	14	6/25/2015	7854	7854	7854
Adelaide Wind Farm	19	6/25/2015	7854	7854	7854
Adelaide Wind Farm	20	6/25/2015	7854	7854	7854
Adelaide Wind Farm	22	6/25/2015	4701	4701	7854
Adelaide Wind Farm	27	6/25/2015	7854	7854	7854
Adelaide Wind Farm	6	6/29/2015	3423	3423	7854
Adelaide Wind Farm	7	6/29/2015	7854	7854	7854
Adelaide Wind Farm	11	6/29/2015	7854	7854	7854
Adelaide Wind Farm	14	6/29/2015	7854	7854	7854

**Table F9: Percent Area Searched Data**

Project Name	Turbine Number	Date	Actual Area Searched M2	Actual Searched Capped M2	Total Area for Survey
Adelaide Wind Farm	17	6/29/2015	4639	4639	7854
Adelaide Wind Farm	19	6/29/2015	7854	7854	7854
Adelaide Wind Farm	20	6/29/2015	7854	7854	7854
Adelaide Wind Farm	22	6/29/2015	4701	4701	7854
Adelaide Wind Farm	27	6/29/2015	7854	7854	7854
Adelaide Wind Farm	6	7/2/2015	3423	3423	7854
Adelaide Wind Farm	11	7/2/2015	7854	7854	7854
Adelaide Wind Farm	12	7/2/2015	6821	6821	7854
Adelaide Wind Farm	20	7/2/2015	7854	7854	7854
Adelaide Wind Farm	22	7/2/2015	4701	4701	7854
Adelaide Wind Farm	27	7/2/2015	7854	7854	7854
Adelaide Wind Farm	17	7/2/2015	4639	4639	7854
Adelaide Wind Farm	14	7/2/2015	7854	7854	7854
Adelaide Wind Farm	19	7/2/2015	7854	7854	7854
Adelaide Wind Farm	6	7/6/2015	3423	3423	7854
Adelaide Wind	11	7/6/2015	7854	7854	7854

**Table F9: Percent Area Searched Data**

Project Name	Turbine Number	Date	Actual Area Searched M2	Actual Searched Capped M2	Total Area for Survey
Farm					
Adelaide Wind Farm	12	7/6/2015	6821	6821	7854
Adelaide Wind Farm	19	7/6/2015	7854	7854	7854
Adelaide Wind Farm	20	7/6/2015	7854	7854	7854
Adelaide Wind Farm	22	7/6/2015	4701	4701	7854
Adelaide Wind Farm	27	7/6/2015	7854	7854	7854
Adelaide Wind Farm	17	7/6/2015	4639	4639	7854
Adelaide Wind Farm	14	7/6/2015	7854	7854	7854
Adelaide Wind Farm	6	7/9/2015	5368	5368	7854
Adelaide Wind Farm	7	7/9/2015	7854	7854	7854
Adelaide Wind Farm	11	7/9/2015	6978	6978	7854
Adelaide Wind Farm	12	7/9/2015	6821	6821	7854
Adelaide Wind Farm	14	7/9/2015	7854	7854	7854
Adelaide Wind Farm	17	7/9/2015	4639	4639	7854
Adelaide Wind Farm	19	7/9/2015	7854	7854	7854
Adelaide Wind Farm	20	7/9/2015	7854	7854	7854

**Table F9: Percent Area Searched Data**

Project Name	Turbine Number	Date	Actual Area Searched M2	Actual Searched Capped M2	Total Area for Survey
Adelaide Wind Farm	27	7/9/2015	7854	7854	7854
Adelaide Wind Farm	6	7/13/2015	5368	5368	7854
Adelaide Wind Farm	11	7/13/2015	7854	7854	7854
Adelaide Wind Farm	14	7/13/2015	7854	7854	7854
Adelaide Wind Farm	17	7/13/2015	4639	4639	7854
Adelaide Wind Farm	27	7/13/2015	7854	7854	7854
Adelaide Wind Farm	22	7/13/2015	5268	5268	7854
Adelaide Wind Farm	20	7/13/2015	7854	7854	7854
Adelaide Wind Farm	19	7/13/2015	7854	7854	7854
Adelaide Wind Farm	12	7/13/2015	2928	2928	7854
Adelaide Wind Farm	7	7/13/2015	7012	7012	7854
Adelaide Wind Farm	6	7/16/2015	5368	5368	7854
Adelaide Wind Farm	7	7/16/2015	7012	7012	7854
Adelaide Wind Farm	11	7/16/2015	7854	7854	7854
Adelaide Wind Farm	12	7/16/2015	2438	2438	7854
Adelaide Wind	14	7/16/2015	7854	7854	7854

**Table F9: Percent Area Searched Data**

Project Name	Turbine Number	Date	Actual Area Searched M2	Actual Searched Capped M2	Total Area for Survey
Farm					
Adelaide Wind Farm	17	7/16/2015	4639	4639	7854
Adelaide Wind Farm	19	7/16/2015	7854	7854	7854
Adelaide Wind Farm	20	7/16/2015	7854	7854	7854
Adelaide Wind Farm	22	7/16/2015	5268	5268	7854
Adelaide Wind Farm	27	7/16/2015	7854	7854	7854
Adelaide Wind Farm	27	7/20/2015	7854	7854	7854
Adelaide Wind Farm	22	7/20/2015	5268	5268	7854
Adelaide Wind Farm	20	7/20/2015	7854	7854	7854
Adelaide Wind Farm	19	7/20/2015	6411	6411	7854
Adelaide Wind Farm	17	7/20/2015	4639	4639	7854
Adelaide Wind Farm	14	7/20/2015	4856	4856	7854
Adelaide Wind Farm	12	7/20/2015	2438	2438	7854
Adelaide Wind Farm	11	7/20/2015	2378	2378	7854
Adelaide Wind Farm	7	7/20/2015	6629	6629	7854
Adelaide Wind Farm	6	7/20/2015	5368	5368	7854

**Table F9: Percent Area Searched Data**

Project Name	Turbine Number	Date	Actual Area Searched M2	Actual Searched Capped M2	Total Area for Survey
Adelaide Wind Farm	6	7/23/2015	6542	6542	7854
Adelaide Wind Farm	7	7/23/2015	6629	6629	7854
Adelaide Wind Farm	11	7/23/2015	2378	2378	7854
Adelaide Wind Farm	14	7/23/2015	4856	4856	7854
Adelaide Wind Farm	17	7/23/2015	4639	4639	7854
Adelaide Wind Farm	19	7/23/2015	6411	6411	7854
Adelaide Wind Farm	22	7/23/2015	5268	5268	7854
Adelaide Wind Farm	27	7/23/2015	7854	7854	7854
Adelaide Wind Farm	12	7/23/2015	2438	2438	7854
Adelaide Wind Farm	6	7/27/2015	6524	6524	7854
Adelaide Wind Farm	7	7/27/2015	6629	6629	7854
Adelaide Wind Farm	12	7/27/2015	2378	2378	7854
Adelaide Wind Farm	14	7/27/2015	4856	4856	7854
Adelaide Wind Farm	17	7/27/2015	4639	4639	7854
Adelaide Wind Farm	19	7/27/2015	6411	6411	7854
Adelaide Wind	22	7/27/2015	5268	5268	7854

**Table F9: Percent Area Searched Data**

Project Name	Turbine Number	Date	Actual Area Searched M2	Actual Searched Capped M2	Total Area for Survey
Farm					
Adelaide Wind Farm	27	7/27/2015	7854	7854	7854
Adelaide Wind Farm	11	7/27/2015	2436	2436	7854
Adelaide Wind Farm	6	7/30/2015	6524	6524	7854
Adelaide Wind Farm	7	7/30/2015	6629	6629	7854
Adelaide Wind Farm	11	7/30/2015	2436	2436	7854
Adelaide Wind Farm	12	7/30/2015	2378	2378	7854
Adelaide Wind Farm	17	7/30/2015	4639	4639	7854
Adelaide Wind Farm	19	7/30/2015	6411	6411	7854
Adelaide Wind Farm	20	7/30/2015	7854	7854	7854
Adelaide Wind Farm	22	7/30/2015	5268	5268	7854
Adelaide Wind Farm	27	7/30/2015	7432	7432	7854
Adelaide Wind Farm	6	8/4/2015	6524	6524	7854
Adelaide Wind Farm	7	8/4/2015	6629	6629	7854
Adelaide Wind Farm	11	8/4/2015	2436	2436	7854
Adelaide Wind Farm	12	8/4/2015	6895	6895	7854



**Table F9: Percent Area Searched Data**

Project Name	Turbine Number	Date	Actual Area Searched M2	Actual Searched Capped M2	Total Area for Survey
Adelaide Wind Farm	17	8/4/2015	7854	7854	7854
Adelaide Wind Farm	19	8/4/2015	6411	6411	7854
Adelaide Wind Farm	20	8/4/2015	7854	7854	7854
Adelaide Wind Farm	22	8/4/2015	5268	5268	7854
Adelaide Wind Farm	27	8/4/2015	7432	7432	7854
Adelaide Wind Farm	14	8/4/2015	3925	3925	7854
Adelaide Wind Farm	6	8/7/2015	6524	6524	7854
Adelaide Wind Farm	7	8/7/2015	6629	6629	7854
Adelaide Wind Farm	11	8/7/2015	1436	1436	7854
Adelaide Wind Farm	12	8/7/2015	9895	7854	7854
Adelaide Wind Farm	14	8/7/2015	3925	3925	7854
Adelaide Wind Farm	17	8/7/2015	7854	7854	7854
Adelaide Wind Farm	19	8/7/2015	6411	6411	7854
Adelaide Wind Farm	20	8/7/2015	7854	7854	7854
Adelaide Wind Farm	22	8/7/2015	5267	5267	7854
Adelaide Wind	27	8/7/2015	7432	7432	7854

**Table F9: Percent Area Searched Data**

Project Name	Turbine Number	Date	Actual Area Searched M2	Actual Searched Capped M2	Total Area for Survey
Farm					
Adelaide Wind Farm	6	8/10/2015	6524	6524	7854
Adelaide Wind Farm	7	8/10/2015	6629	6629	7854
Adelaide Wind Farm	11	8/10/2015	2436	2436	7854
Adelaide Wind Farm	12	8/10/2015	6895	6895	7854
Adelaide Wind Farm	14	8/10/2015	3925	3925	7854
Adelaide Wind Farm	17	8/11/2015	7854	7854	7854
Adelaide Wind Farm	19	8/11/2015	6411	6411	7854
Adelaide Wind Farm	20	8/11/2015	7854	7854	7854
Adelaide Wind Farm	22	8/11/2015	5267	5267	7854
Adelaide Wind Farm	27	8/11/2015	7432	7432	7854
Adelaide Wind Farm	6	8/13/2015	6524	6524	7854
Adelaide Wind Farm	7	8/13/2015	6629	6629	7854
Adelaide Wind Farm	11	8/13/2015	2436	2436	7854
Adelaide Wind Farm	12	8/13/2015	6895	6895	7854
Adelaide Wind Farm	14	8/13/2015	3925	3925	7854

**Table F9: Percent Area Searched Data**

Project Name	Turbine Number	Date	Actual Area Searched M2	Actual Searched Capped M2	Total Area for Survey
Adelaide Wind Farm	17	8/13/2015	7854	7854	7854
Adelaide Wind Farm	19	8/13/2015	6411	6411	7854
Adelaide Wind Farm	20	8/13/2015	7854	7854	7854
Adelaide Wind Farm	22	8/13/2015	5267	5267	7854
Adelaide Wind Farm	27	8/13/2015	7432	7432	7854
Adelaide Wind Farm	6	8/17/2015	6524	6524	7854
Adelaide Wind Farm	7	8/17/2015	6629	6629	7854
Adelaide Wind Farm	11	8/17/2015	2436	2436	7854
Adelaide Wind Farm	14	8/17/2015	3925	3925	7854
Adelaide Wind Farm	17	8/17/2015	7854	7854	7854
Adelaide Wind Farm	19	8/17/2015	6411	6411	7854
Adelaide Wind Farm	20	8/17/2015	7854	7854	7854
Adelaide Wind Farm	22	8/17/2015	5267	5267	7854
Adelaide Wind Farm	27	8/17/2015	7432	7432	7854
Adelaide Wind Farm	6	8/20/2015	6524	6524	7854
Adelaide Wind	7	8/20/2015	6629	6629	7854

**Table F9: Percent Area Searched Data**

Project Name	Turbine Number	Date	Actual Area Searched M2	Actual Searched Capped M2	Total Area for Survey
Farm					
Adelaide Wind Farm	11	8/20/2015	2436	2436	7854
Adelaide Wind Farm	12	8/20/2015	6895	6895	7854
Adelaide Wind Farm	14	8/20/2015	3925	3925	7854
Adelaide Wind Farm	17	8/20/2015	7854	7854	7854
Adelaide Wind Farm	20	8/20/2015	7854	7854	7854
Adelaide Wind Farm	22	8/20/2015	5267	5267	7854
Adelaide Wind Farm	27	8/20/2015	7432	7432	7854
Adelaide Wind Farm	6	8/24/2015	6524	6524	7854
Adelaide Wind Farm	7	8/24/2015	7173	7173	7854
Adelaide Wind Farm	11	8/24/2015	2436	2436	7854
Adelaide Wind Farm	12	8/24/2015	6895	6895	7854
Adelaide Wind Farm	14	8/24/2015	3925	3925	7854
Adelaide Wind Farm	17	8/24/2015	7854	7854	7854
Adelaide Wind Farm	19	8/24/2015	7854	7854	7854
Adelaide Wind Farm	22	8/24/2015	5267	5267	7854

**Table F9: Percent Area Searched Data**

Project Name	Turbine Number	Date	Actual Area Searched M2	Actual Searched Capped M2	Total Area for Survey
Adelaide Wind Farm	27	8/24/2015	7432	7432	7854
Adelaide Wind Farm	6	8/27/2015	6524	6524	7854
Adelaide Wind Farm	11	8/27/2015	2436	2436	7854
Adelaide Wind Farm	12	8/27/2015	6895	6895	7854
Adelaide Wind Farm	14	8/27/2015	3925	3925	7854
Adelaide Wind Farm	17	8/27/2015	7854	7854	7854
Adelaide Wind Farm	19	8/27/2015	7854	7854	7854
Adelaide Wind Farm	20	8/27/2015	5267	5267	7854
Adelaide Wind Farm	22	8/27/2015	7432	7432	7854
Adelaide Wind Farm	7	8/27/2015	7173	7173	7854
Adelaide Wind Farm	6	8/31/2015	6524	6524	7854
Adelaide Wind Farm	7	8/31/2015	7173	7173	7854
Adelaide Wind Farm	11	8/31/2015	2436	2436	7854
Adelaide Wind Farm	12	8/31/2015	6895	6895	7854
Adelaide Wind Farm	14	8/31/2015	3925	3925	7854
Adelaide Wind	17	8/31/2015	7854	7854	7854

**Table F9: Percent Area Searched Data**

Project Name	Turbine Number	Date	Actual Area Searched M2	Actual Searched Capped M2	Total Area for Survey
Farm					
Adelaide Wind Farm	19	8/31/2015	7854	7854	7854
Adelaide Wind Farm	20	8/31/2015	7854	7854	7854
Adelaide Wind Farm	22	8/31/2015	5267	5267	7854
Adelaide Wind Farm	27	8/31/2015	7432	7432	7854
Adelaide Wind Farm	6	9/3/2015	6524	6524	7854
Adelaide Wind Farm	11	9/3/2015	2436	2436	7854
Adelaide Wind Farm	12	9/3/2015	6895	6895	7854
Adelaide Wind Farm	14	9/3/2015	3925	3925	7854
Adelaide Wind Farm	17	9/3/2015	7854	7854	7854
Adelaide Wind Farm	19	9/3/2015	7854	7854	7854
Adelaide Wind Farm	6	9/7/2015	6524	6524	7854
Adelaide Wind Farm	7	9/7/2015	7173	7173	7854
Adelaide Wind Farm	11	9/7/2015	2436	2436	7854
Adelaide Wind Farm	12	9/7/2015	6895	6895	7854
Adelaide Wind Farm	14	9/7/2015	3925	3925	7854

**Table F9: Percent Area Searched Data**

Project Name	Turbine Number	Date	Actual Area Searched M2	Actual Searched Capped M2	Total Area for Survey
Adelaide Wind Farm	17	9/7/2015	7854	7854	7854
Adelaide Wind Farm	19	9/7/2015	7854	7854	7854
Adelaide Wind Farm	20	9/7/2015	7854	7854	7854
Adelaide Wind Farm	22	9/7/2015	5267	5267	7854
Adelaide Wind Farm	27	9/7/2015	7432	7432	7854
Adelaide Wind Farm	6	9/10/2015	6524	6524	7854
Adelaide Wind Farm	7	9/10/2015	7173	7173	7854
Adelaide Wind Farm	11	9/10/2015	2436	2436	7854
Adelaide Wind Farm	12	9/10/2015	6895	6895	7854
Adelaide Wind Farm	14	9/10/2015	3925	3925	7854
Adelaide Wind Farm	17	9/10/2015	7854	7854	7854
Adelaide Wind Farm	19	9/10/2015	7854	7854	7854
Adelaide Wind Farm	20	9/10/2015	7854	7854	7854
Adelaide Wind Farm	27	9/10/2015	7432	7432	7854
Adelaide Wind Farm	6	9/14/2015	2745	2745	7854
Adelaide Wind	7	9/14/2015	7173	7173	7854

**Table F9: Percent Area Searched Data**

Project Name	Turbine Number	Date	Actual Area Searched M2	Actual Searched Capped M2	Total Area for Survey
Farm					
Adelaide Wind Farm	11	9/14/2015	2436	2436	7854
Adelaide Wind Farm	12	9/14/2015	6895	6895	7854
Adelaide Wind Farm	14	9/14/2015	3925	3925	7854
Adelaide Wind Farm	17	9/14/2015	7854	7854	7854
Adelaide Wind Farm	19	9/14/2015	7854	7854	7854
Adelaide Wind Farm	20	9/14/2015	7854	7854	7854
Adelaide Wind Farm	22	9/14/2015	5267	5267	7854
Adelaide Wind Farm	27	9/14/2015	7432	7432	7854
Adelaide Wind Farm	6	9/17/2015	2745	2745	7854
Adelaide Wind Farm	7	9/17/2015	7173	7173	7854
Adelaide Wind Farm	11	9/17/2015	2436	2436	7854
Adelaide Wind Farm	12	9/17/2015	6895	6895	7854
Adelaide Wind Farm	14	9/17/2015	3925	3925	7854
Adelaide Wind Farm	17	9/17/2015	7854	7854	7854
Adelaide Wind Farm	19	9/17/2015	7854	7854	7854



**Table F9: Percent Area Searched Data**

Project Name	Turbine Number	Date	Actual Area Searched M2	Actual Searched Capped M2	Total Area for Survey
Adelaide Wind Farm	20	9/17/2015	7854	7854	7854
Adelaide Wind Farm	22	9/17/2015	5267	5267	7854
Adelaide Wind Farm	27	9/17/2015	7432	7432	7854
Adelaide Wind Farm	6	9/21/2015	2745	2745	7854
Adelaide Wind Farm	7	9/21/2015	7173	7173	7854
Adelaide Wind Farm	12	9/21/2015	6895	6895	7854
Adelaide Wind Farm	14	9/21/2015	3925	3925	7854
Adelaide Wind Farm	17	9/21/2015	7854	7854	7854
Adelaide Wind Farm	19	9/21/2015	7854	7854	7854
Adelaide Wind Farm	20	9/21/2015	7854	7854	7854
Adelaide Wind Farm	22	9/21/2015	5267	5267	7854
Adelaide Wind Farm	27	9/21/2015	7432	7432	7854
Adelaide Wind Farm	11	9/21/2015	2436	2436	7854
Adelaide Wind Farm	6	9/24/2015	2745	2745	7854
Adelaide Wind Farm	7	9/24/2015	7173	7173	7854
Adelaide Wind	11	9/24/2015	2436	2436	7854

**Table F9: Percent Area Searched Data**

Project Name	Turbine Number	Date	Actual Area Searched M2	Actual Searched Capped M2	Total Area for Survey
Farm					
Adelaide Wind Farm	14	9/24/2015	3925	3925	7854
Adelaide Wind Farm	17	9/24/2015	7854	7854	7854
Adelaide Wind Farm	19	9/24/2015	7854	7854	7854
Adelaide Wind Farm	22	9/24/2015	5267	5267	7854
Adelaide Wind Farm	27	9/24/2015	7432	7432	7854
Adelaide Wind Farm	20	9/24/2015	7854	7854	7854
Adelaide Wind Farm	12	9/24/2015	6895	6895	7854
Adelaide Wind Farm	7	9/28/2015	7173	7173	7854
Adelaide Wind Farm	6	9/28/2015	6175	6175	7854
Adelaide Wind Farm	11	9/28/2015	2436	2436	7854
Adelaide Wind Farm	12	9/28/2015	7854	7854	7854
Adelaide Wind Farm	14	9/28/2015	3925	3925	7854
Adelaide Wind Farm	17	9/28/2015	7854	7854	7854
Adelaide Wind Farm	19	9/28/2015	7854	7854	7854
Adelaide Wind Farm	20	9/28/2015	7854	7854	7854

**Table F9: Percent Area Searched Data**

Project Name	Turbine Number	Date	Actual Area Searched M2	Actual Searched Capped M2	Total Area for Survey
Adelaide Wind Farm	22	9/28/2015	5267	5267	7854
Adelaide Wind Farm	27	9/28/2015	7854	7854	7854
Adelaide Wind Farm	6	10/1/2015	2745	2745	7854
Adelaide Wind Farm	7	10/1/2015	7173	7173	7854
Adelaide Wind Farm	11	10/1/2015	2436	2436	7854
Adelaide Wind Farm	12	10/1/2015	6895	6895	7854
Adelaide Wind Farm	14	10/1/2015	3925	3925	7854
Adelaide Wind Farm	17	10/1/2015	7854	7854	7854
Adelaide Wind Farm	19	10/1/2015	7854	7854	7854
Adelaide Wind Farm	20	10/1/2015	7854	7854	7854
Adelaide Wind Farm	22	10/1/2015	5267	5267	7854
Adelaide Wind Farm	27	10/1/2015	7854	7854	7854
Adelaide Wind Farm	7	10/5/2015	7173	7173	7854
Adelaide Wind Farm	6	10/5/2015	7854	7854	7854
Adelaide Wind Farm	11	10/5/2015	7854	7854	7854
Adelaide Wind	12	10/5/2015	7854	7854	7854

**Table F9: Percent Area Searched Data**

Project Name	Turbine Number	Date	Actual Area Searched M2	Actual Searched Capped M2	Total Area for Survey
Farm					
Adelaide Wind Farm	14	10/5/2015	3925	3925	7854
Adelaide Wind Farm	17	10/5/2015	7854	7854	7854
Adelaide Wind Farm	19	10/5/2015	7854	7854	7854
Adelaide Wind Farm	20	10/5/2015	7854	7854	7854
Adelaide Wind Farm	22	10/5/2015	5267	5267	7854
Adelaide Wind Farm	27	10/5/2015	7854	7854	7854
Adelaide Wind Farm	7	10/8/2015	7173	7173	7854
Adelaide Wind Farm	6	10/8/2015	7854	7854	7854
Adelaide Wind Farm	11	10/8/2015	7854	7854	7854
Adelaide Wind Farm	12	10/8/2015	7854	7854	7854
Adelaide Wind Farm	14	10/8/2015	3925	3925	7854
Adelaide Wind Farm	17	10/8/2015	7854	7854	7854
Adelaide Wind Farm	19	10/8/2015	7854	7854	7854
Adelaide Wind Farm	20	10/8/2015	7854	7854	7854
Adelaide Wind Farm	22	10/8/2015	5267	5267	7854

**Table F9: Percent Area Searched Data**

Project Name	Turbine Number	Date	Actual Area Searched M2	Actual Searched Capped M2	Total Area for Survey
Adelaide Wind Farm	27	10/8/2015	7854	7854	7854
Adelaide Wind Farm	7	10/12/2015	7854	7854	7854
Adelaide Wind Farm	6	10/12/2015	7854	7854	7854
Adelaide Wind Farm	11	10/12/2015	7854	7854	7854
Adelaide Wind Farm	12	10/12/2015	7854	7854	7854
Adelaide Wind Farm	14	10/12/2015	4712	4712	7854
Adelaide Wind Farm	17	10/12/2015	7854	7854	7854
Adelaide Wind Farm	19	10/12/2015	7854	7854	7854
Adelaide Wind Farm	22	10/12/2015	5267	5267	7854
Adelaide Wind Farm	27	10/12/2015	7854	7854	7854
Adelaide Wind Farm	7	10/15/2015	7854	7854	7854
Adelaide Wind Farm	6	10/15/2015	7854	7854	7854
Adelaide Wind Farm	11	10/15/2015	7854	7854	7854
Adelaide Wind Farm	12	10/15/2015	7854	7854	7854
Adelaide Wind Farm	14	10/15/2015	4712	4712	7854
Adelaide Wind	17	10/15/2015	7854	7854	7854

**Table F9: Percent Area Searched Data**

Project Name	Turbine Number	Date	Actual Area Searched M2	Actual Searched Capped M2	Total Area for Survey
Farm					
Adelaide Wind Farm	20	10/15/2015	7854	7854	7854
Adelaide Wind Farm	22	10/15/2015	5267	5267	7854
Adelaide Wind Farm	27	10/15/2015	7854	7854	7854
Adelaide Wind Farm	27	10/19/2015	7854	7854	7854
Adelaide Wind Farm	22	10/19/2015	5267	5267	7854
Adelaide Wind Farm	20	10/19/2015	7854	7854	7854
Adelaide Wind Farm	19	10/19/2015	7854	7854	7854
Adelaide Wind Farm	17	10/19/2015	7854	7854	7854
Adelaide Wind Farm	14	10/19/2015	4712	4712	7854
Adelaide Wind Farm	12	10/19/2015	7854	7854	7854
Adelaide Wind Farm	6	10/19/2015	7854	7854	7854
Adelaide Wind Farm	7	10/19/2015	7854	7854	7854
Adelaide Wind Farm	27	10/22/2015	7854	7854	7854
Adelaide Wind Farm	22	10/22/2015	5267	5267	7854
Adelaide Wind Farm	19	10/22/2015	7854	7854	7854

**Table F9: Percent Area Searched Data**

Project Name	Turbine Number	Date	Actual Area Searched M2	Actual Searched Capped M2	Total Area for Survey
Adelaide Wind Farm	17	10/22/2015	7854	7854	7854
Adelaide Wind Farm	14	10/22/2015	4712	4712	7854
Adelaide Wind Farm	12	10/22/2015	7854	7854	7854
Adelaide Wind Farm	7	10/22/2015	7854	7854	7854
Adelaide Wind Farm	6	10/22/2015	7854	7854	7854
Adelaide Wind Farm	7	10/26/2015	7854	7854	7854
Adelaide Wind Farm	6	10/26/2015	7854	7854	7854
Adelaide Wind Farm	12	10/26/2015	7854	7854	7854
Adelaide Wind Farm	14	10/26/2015	7854	7854	7854
Adelaide Wind Farm	17	10/26/2015	7854	7854	7854
Adelaide Wind Farm	20	10/26/2015	7854	7854	7854
Adelaide Wind Farm	22	10/26/2015	7854	7854	7854
Adelaide Wind Farm	27	10/26/2015	7854	7854	7854
Adelaide Wind Farm	7	10/29/2015	7854	7854	7854
Adelaide Wind Farm	6	10/29/2015	7854	7854	7854
Adelaide Wind	12	10/29/2015	7854	7854	7854

**Table F9: Percent Area Searched Data**

Project Name	Turbine Number	Date	Actual Area Searched M2	Actual Searched Capped M2	Total Area for Survey
Farm					
Adelaide Wind Farm	14	10/29/2015	7854	7854	7854
Adelaide Wind Farm	17	10/29/2015	7854	7854	7854
Adelaide Wind Farm	19	10/29/2015	7854	7854	7854
Adelaide Wind Farm	20	10/29/2015	7854	7854	7854
Adelaide Wind Farm	22	10/29/2015	7854	7854	7854
Adelaide Wind Farm	27	10/29/2015	7854	7854	7854



**Table F10: Percent Area Searched Summary**

Project Name	Year	Month	Treatment Group	Month Start	Month End	Search Area Shape	Search Area Dimension	Total Required Survey Area M2	Total Actual Area Searched M2	Percent Area Surveyed Ps
Adelaide Wind Farm	2015	May	Subset	5	5	circular	50m radius, 100m by 100m	612612	608750	0.993695847
Adelaide Wind Farm	2015	June	Subset	6	6	circular	50m radius, 100m by 100m	644028	560997	0.871075481
Adelaide Wind Farm	2015	July	Subset	7	7	circular	50m radius, 100m by 100m	659736	506540	0.767791965
Adelaide Wind Farm	2015	August	Subset	8	8	circular	50m radius, 100m by 100m	675444	527950	0.781634007
Adelaide Wind Farm	2015	September	Subset	9	9	circular	50m radius, 100m by 100m	589050	458635	0.778601137
Adelaide Wind Farm	2015	October	Subset	10	10	circular	50m radius, 100m by 100m	644028	588035	0.913058128

**Table F11: Weekly Monitoring Mortality Record**

Project Name	Turbine Number	Day	Month	Year	Start Time	Precipitation	Wind Speed	Temp.	Species Name Common	Species Name Scientific	Species Code	Sex	Carcass Utm Zone	Carcass Easting Nad83	Carcass Northing Nad83	Distance from Turbine (m)	Direction from Turbine	Carcass Condition	Injuries	Time Since Death Hours	Substrate	Visibility Class	Comments
Adelaide Wind Farm	22	8	6	2015	16:35	Rain	16	19-23	Silver-haired Bat	<i>Lasionycteris noctivagans</i>	LANO	Unknown	17	438269	4763206	35	West	Moderate decomposition	None visible	168	Field	1	
Adelaide Wind Farm	11	11	6	2015	9:23	None	5 to 13	14-23	Red-tailed Hawk	<i>Buteo jamaicensis</i>	RTHA	Unknown	17	449183	4763594	57	SE	Early decomposition	Wound to abdomen, broken neck	24	Soy, dirt	1	Found outside of search area radius during regular mortality monitoring.
Adelaide Wind Farm	6	15	6	2015	14:41	Fog/drizzle	12	23-24	Red-tailed Hawk	<i>Buteo jamaicensis</i>	RTHA	Unknown	17	451953	4762617	30	WNW	Early decomposition	Broken neck	24	Dirt	1	
Adelaide Wind Farm	27	18	6	2015	11:00	None	14	19	Turkey Vulture	<i>Cathartes aura</i>	TUVU	Unknown	17	435959	4765488	17	N	Fresh	Broken wing	48	Ground	1	
Adelaide Wind Farm	27	18	6	2015	11:00	None	14	19	Turkey Vulture	<i>Cathartes aura</i>	TUVU	Unknown	17	435912	4765441	52	SW	Fresh	Broken wing, head injury	48	Ground	1	
Adelaide Wind Farm	11	2	7	2015	9:15	None	5	16-21	Big Brown Bat	<i>Eptesicus fuscus</i>	EPFU	Unknown	17	449093	4763602	53	WSW	Advanced decomposition	None visible	2-3 weeks	Soy	2	
Adelaide Wind Farm	17	9	7	2015	13:45	Light rain	6	18	Mourning Dove	<i>Zenaidura macroura</i>	MODO	Unknown	17	444527	4765049	21	ESE	Fresh	None visible	<24 hours	Grass	2	
Adelaide Wind Farm	7	13	7	2015	17:15	None	13	20-27	Big Brown Bat	<i>Eptesicus fuscus</i>	EPFU	Male	17	449653	4762137	14	SW	Fresh	Severed wing	<24 hours	Gravel	1	
Adelaide Wind Farm	12	16	7	2015	11:40	None	10	18-23	Big Brown Bat	<i>Eptesicus fuscus</i>	EPFU	Male	17	447868	4763342	10	S	Early decomposition	None visible	72 hours	Grass	2	
Adelaide Wind Farm	27	20	7	2015	9:30	None	14	27	Hoary Bat	<i>Lasiurus cinereus</i>	LACI	Unknown	17	435938	4765448	27	SW	Fresh	None visible	<24	grassy ground	2	
Adelaide Wind Farm	19	20	7	2015	11:40	None	14	27	Hoary Bat	<i>Lasiurus cinereus</i>	LACI	Male	17	442939	4764962	8	NW	Fresh	None visible	<48	ground	1	
Adelaide Wind Farm	6	23	7	2015	8:50	None	10	20-24	Hoary Bat	<i>Lasiurus cinereus</i>	LACI	Unknown	17	451982	4762593	15	SW	Fresh	None visible	<24	Gravel	1	
Adelaide Wind Farm	22	27	7	2015	13:55	None	2	27-31	Hoary Bat	<i>Lasiurus cinereus</i>	LACI	Unknown	17	438309	4763242	23	N	Fresh	None visible	<24	Ground	1	
Adelaide	17	30	7	2015	11:55	None	14	19-30	Cliff Swallow	<i>Petrochelidon</i>	CLSW	Unknown	17	444507	4765053	16	S	Early	Head injury	48	Grass/Gr	2	

**Table F11: Weekly Monitoring Mortality Record**

Project Name	Turbine Number	Day	Month	Year	Start Time	Precipitation	Wind Speed	Temp.	Species Name Common	Species Name Scientific	Species Code	Sex	Carcass Utm Zone	Carcass Easting Nad83	Carcass Northing Nad83	Distance from Turbine (m)	Direction from Turbine	Carcass Condition	Injuries	Time Since Death Hours	Substrate	Visibility Class	Comments
Wind Farm										<i>pyrrhonota</i>								decomposition			avel		
Adelaide Wind Farm	20	30	7	2015	13:55	None	14	19-30	Big Brown Bat	<i>Eptesicus fuscus</i>	EPFU	Unknown	17	440245	4765223	10	W	Moderate decomposition	None visible	1 week	Gravel	1	
Adelaide Wind Farm	6	4	8	2015	8:45	None	5	22-24	Big Brown Bat	<i>Eptesicus fuscus</i>	EPFU	Unknown	17	451979	4762626	10	SW	Moderate decomposition	None visible	1 week	Ground	1	
Adelaide Wind Farm	22	4	8	2015	13:55	None	5	22-24	Big Brown Bat	<i>Eptesicus fuscus</i>	EPFU	Unknown	17	438316	4763201	7	SE	Moderate decomposition	None visible	1 week	Ground	1	
Adelaide Wind Farm	6	10	8	2015	8:45	Light rain	6	17-25	Tree Swallow	<i>Tachycineta bicolor</i>	TRES	Unknown	17	451962	4762607	13	SW	Early decomposition	Broken Wing	2-3 days	Gravel	1	
Adelaide Wind Farm	14	10	8	2015	12:05	Light rain	6	17-25	Hoary Bat	<i>Lasiurus cinereus</i>	LACI	Unknown	17	447209	4764827	41	SE	Early decomposition	None visible	3 days	Soy	2	
Adelaide Wind Farm	19	11	8	2015	11:25	None	18	20-22	Tree Swallow (juv)	<i>Tachycineta bicolor</i>	TRES	Unknown	17	442961	4764997	33	NE	Early decomposition	None visible	2-3 days	Ground	1	
Adelaide Wind Farm	20	11	8	2015	12:20	None	18	20-22	Hoary Bat	<i>Lasiurus cinereus</i>	LACI	Unknown	17	440262	4765182	39	S	Fresh	None visible	24	Ground	1	
Adelaide Wind Farm	20	11	8	2015	12:20	None	18	20-22	Big Brown Bat	<i>Eptesicus fuscus</i>	EPFU	Unknown	17	440245	4765218	13	NW	Fresh	None visible	24	Ground	1	
Adelaide Wind Farm	17	17	8	2015	11:30	None	11	25-30	Red Bat	<i>Lasiurus borealis</i>	LABO	Unknown	17	444521	4765065	16	E	Moderate decomposition	None visible	3-4 days	Gravel	1	
Adelaide Wind Farm	11	24	8	2015	11:05	None	11	15	Hoary Bat	<i>Lasiurus cinereus</i>	LACI	Unknown	17	449157	4763628	7	NW	Fresh	None visible	24	Gravel	1	
Adelaide Wind Farm	17	24	8	2015	13:55	None	11	15	Red Bat	<i>Lasiurus borealis</i>	LABO	Unknown	17	444505	4765113	46	NW	Advanced decomposition	None visible	1-2 weeks	Ground	1	
Adelaide Wind Farm	19	24	8	2015	15:05	None	11	15	Big Brown Bat	<i>Eptesicus fuscus</i>	EPFU	Unknown	17	442945	4764987	18	NE	Early decomposition	None visible	3 days	Ground	1	
Adelaide Wind Farm	11	27	8	2015	9:25	None	6	14	Hoary Bat	<i>Lasiurus cinereus</i>	LACI	Unknown	17	449149	4766329	8	NE	Fresh	None visible	<24	Soy	2	
Adelaide Wind Farm	6	31	8	2015	9:20	None	3	20	Hoary Bat	<i>Lasiurus cinereus</i>	LACI	Unknown	17	451976	4762602	3	W	Fresh	Head injury	<24	Grass	2	

**Table F11: Weekly Monitoring Mortality Record**

Project Name	Turbine Number	Day	Month	Year	Start Time	Precipitation	Wind Speed	Temp.	Species Name Common	Species Name Scientific	Species Code	Sex	Carcass Utm Zone	Carcass Easting Nad83	Carcass Northing Nad83	Distance from Turbine (m)	Direction from Turbine	Carcass Condition	Injuries	Time Since Death Hours	Substrate	Visibility Class	Comments
Adelaide Wind Farm	6	31	8	2015	9:20	None	3	20	Hoary Bat	<i>Lasiurus cinereus</i>	LACI	Unknown	17	451977	4762606	10	SW	Fresh	None visible	<24	Gravel	1	
Adelaide Wind Farm	12	31	8	2015	11:00	None	3	20	Hoary Bat	<i>Lasiurus cinereus</i>	LACI	Unknown	17	447887	4763391	31	NE	Fresh	None visible	<24	Ground	1	
Adelaide Wind Farm	14	31	8	2015	12:10	None	3	20	Big Brown Bat	<i>Eptesicus fuscus</i>	EPFU	Unknown	17	447170	4764853	3	SE	Fresh	Broken limb	1-2 days	Ground	1	
Adelaide Wind Farm	17	31	8	2015	13:10	None	3	20	Hoary Bat	<i>Lasiurus cinereus</i>	LACI	Unknown	17	444556	4764090	48	NE	Early decomposition	None visible	3-4 days	Ground	1	
Adelaide Wind Farm	6	3	9	2015	8:40	None	3	25-30	Silver-haired Bat	<i>Lasionycteris noctivagans</i>	LANO	Unknown	17	451965	4762571	30	SW	Moderate decomposition	None visible	1 week	Grass/Gravel	2	
Adelaide Wind Farm	6	3	9	2015	8:40	None	3	25-30	Silver-haired Bat	<i>Lasionycteris noctivagans</i>	LANO	Unknown	17	451967	4762624	17	NW	Fresh	Broken limb	1-3 days	Ground	1	
Adelaide Wind Farm	6	3	9	2015	8:40	None	3	25-30	Big Brown Bat	<i>Eptesicus fuscus</i>	EPFU	Unknown	17	451974	4762615	7	E	Early decomposition	None visible	1-3 days	Grass/Gravel	2	
Adelaide Wind Farm	11	3	9	2015	10:25	None	3	25-30	Tree Swallow	<i>Tachycineta bicolor</i>	TRES	Unknown	17	449152	4763630	16	N	Advanced decomposition	None visible	2-3 weeks	Soy	2/3	
Adelaide Wind Farm	12	3	9	2015	11:15	None	3	25-30	Hoary Bat	<i>Lasiurus cinereus</i>	LACI	Unknown	17	447900	4763337	39	SE	Fresh	None visible	<24	Ground	1	
Adelaide Wind Farm	17	3	9	2015	13:05	None	3	25-30	Hoary Bat	<i>Lasiurus cinereus</i>	LACI	Male	17	444551	4765066	43	E	Fresh	Broken limb	<24	Gravel	1	
Adelaide Wind Farm	17	3	9	2015	13:05	None	3	25-30	Silver-haired Bat	<i>Lasionycteris noctivagans</i>	LANO	Female	17	444518	4765051	17	SE	Advanced decomposition	None visible	2 weeks	Grass	2	
Adelaide Wind Farm	17	3	9	2015	13:05	None	3	25-30	Hoary Bat	<i>Lasiurus cinereus</i>	LACI	Unknown	17	444510	4765050	18	S	Fresh	None visible	<24	Ground	1	
Adelaide Wind Farm	7	7	9	2015	9:30	None	13	26-31	Silver-haired Bat	<i>Lasionycteris noctivagans</i>	LANO	Unknown	17	449652	4762127	20	SW	Moderate decomposition	None visible	1-2 weeks	grass/gravel	1	
Adelaide Wind Farm	19	7	9	2015	12:55	None	13	26-31	Silver-haired Bat	<i>Lasionycteris noctivagans</i>	LANO	Unknown	17	442925	4764959	9	NW	Moderate decomposition	None visible	1-2 weeks	Ground	1	
Adelaide Wind Farm	20	7	9	2015	13:40	None	13	26-31	Tree Swallow	<i>Tachycineta bicolor</i>	TRES	Unknown	17	442936	4764976	13	NE	Moderate decomposition	None visible	1-2 weeks	Ground	1	

**Table F11: Weekly Monitoring Mortality Record**

Project Name	Turbine Number	Day	Month	Year	Start Time	Precipitation	Wind Speed	Temp.	Species Name Common	Species Name Scientific	Species Code	Sex	Carcass Utm Zone	Carcass Easting Nad83	Carcass Northing Nad83	Distance from Turbine (m)	Direction from Turbine	Carcass Condition	Injuries	Time Since Death Hours	Substrate	Visibility Class	Comments
Adelaide Wind Farm	20	24	9	2015	14:40	None	11	16-24	Silver-haired Bat	<i>Lasionycteris noctivagans</i>	LANO	Unknown	17	440288	4765199	37	SE	Fresh	Broken Wing	1-2 days	Ground	1	
Adelaide Wind Farm	20	1	10	2015	14:10	None	16	8 to 15	Ovenbird	<i>Seiurus aurocapilla</i>	OVEN	Unknown	17	440282	4765189	40	SE	Fresh	None visible	<24 hours	Ground	1	
Adelaide Wind Farm	20	8	10	2015	14:10	None	8	14	Golden-crowned Kinglet	<i>Regulus satrapa</i>	GCKI	Unknown	17	440230	4765190	40	SW	Fresh	None visible	<24	G	1	
Adelaide Wind Farm	27	12	10	2015	15:10	None	23	18	Hoary Bat	<i>Lasiurus cinereus</i>	LACI	Unknown	17	435939	4765477	35	NW	Advanced decomposition	None visible	2-3 weeks	Grass/ground	2	
Adelaide Wind Farm	27	12	10	2015	15:10	None	23	18	Hoary Bat	<i>Lasiurus borealis</i>	LABO	Unknown	17	435943	4765463	25	W	Advanced decomposition	None visible	2-3 weeks	Grass/ground	2	
Adelaide Wind Farm	14	15	10	2015	12:05	None	18	14	Golden-crowned Kinglet	<i>Regulus satrapa</i>	GCKI	Unknown	17	447193	4764890	41	NE	Fresh	None visible	<24 hours	Grass/ground	2	
Adelaide Wind Farm	22	15	10	2015	15:25	None	18	14	Horned Lark	<i>Eremophila alpestris</i>	HOLA	Unknown	17	438309	4763214	7	NW	Advanced decomposition	None visible	2-3 weeks	Grass/ground	2	

**Table F12: Raptor Monitoring Mortality Record**

Project Name	Turbine Number	Day	Month	Year	Start Time	Precipitation	Wind Speed	Temp	Species Name Common	Species Name Scientific	Species Code	Sex	Carcass Utm Zone	Carcass Easting Nad83	Carcass Northing Nad83	Distance from Turbine (m)	Direction from Turbine	Carcass Condition	Injuries	Time Since Death Hours	Substrate	Visibility Class	Survey Type
Adelaide Wind Farm	18	5	6	2015	n/a	None	11	20	Big Brown Bat	<i>Eptesicus fuscus</i>	EPFU	unknown	17	443804	4765067	3	N	Live	Severed Wing	0	Gravel	1	Found incidentally by Suncor Maintenance crew.
Adelaide Wind Farm	15	19	6	2015	11:50	None	6	22	Yellow-billed Cuckoo	<i>Coccyzus americanus</i>	YBCU	unknown	17	446076	4765059	51	NW	Fresh	None visible	24	Field	2	Found during June SAR Survey
Adelaide Wind Farm	9	21	6	2015	12:45	None	18	22	Osprey	<i>Pandion haliaetus</i>	OSPR	unknown	17	449748	4763043	50	S	Moderate	None visible	2 weeks	Field	2	Found during June SAR Survey
Adelaide Wind Farm	5	25	8	2015	8:40	None	14	14	Silver-haired Bat	<i>Lasionycteris noctivagans</i>	LANO	unknown	17	451177	4762371	24	NW	Advanced	None visible	2-3 weeks	ground	1	Found during August SAR Survey
Adelaide Wind Farm	21	25	8	2015	16:00	None	14	14	Horned Lark	<i>Eremophila alpestris</i>	HOLA	unknown	17	439187	4763527	25	W	Complete	None visible	Month	grass	2	Found during August SAR Survey
Adelaide Wind Farm	21	25	8	2015	16:00	None	14	14	Hoary Bat	<i>Lasiurus cinereus</i>	LACI	unknown	17	439173	4763559	21	NE	Fresh	Broken Wing	24	ground	1	Found during August SAR Survey
Adelaide Wind Farm	21	25	8	2015	16:00	None	14	14	Little Brown Myotis	<i>Myotis lucifugus</i>	MYLU	unknown	17	439155	4763541	5	NW	Moderate	None visible	1-2 weeks	gravel	1	Found during August SAR Survey
Adelaide Wind Farm	15	21	9	2015	9:34	None	12-18	10-21	Silver-haired Bat	<i>Lasionycteris noctivagans</i>	LANO	unknown	17	445996	4764984	13	E	Advanced	None visible	168	gravel	1	Found during September SAR Survey

## **APPENDIX G: FIELD FORMS**

*APPENDIX G1:  
FIELD FORMS  
(MORTALITY MONITORING)*



### Searcher Efficiency Record Form

Project No: 160961010      Project Name: Adelalde Wind Farm

Date: May 7, 2015      Field Personnel: Ken Edwards

TESTER: Anna Corrigan

Weather Conditions: 12-16 TEMP (°C)    3km/h / N WIND (speed / direction)    10-20% CLOUD    Ø PPT    Ø PPT (last 24-hrs)

% VEG. COVER	VEG. HEIGHT	VISIBILITY CLASS*
≥ 90% bare ground	≤ 15cm tall	Class 1 (Easy)
≥ 25% bare ground	≤ 15cm tall	Class 2 (Moderate)
≤ 25% bare ground	≤ 25% > 30cm tall	Class 3 (Difficult)
Little/no bare ground	≥ 25% > 30cm tall	Class 4 (Very difficult)

Turbine No.	Time Placed	Time Collected	Species	Marker Used	Condition frozen/thawed	UTM Coordinates			Position from turbine		Substrate	Visibility Class*	Detected?	Scavenged?
						Zone	Easting	Northing	Dist. (m)	Direction				
6	7:05am	n/a	Eastern Red	Black	Thawed	17	E 0451	N 4762	4	W	gravel	1	<input checked="" type="checkbox"/> -Y / <input type="checkbox"/> -N	<input type="checkbox"/> -Y / <input checked="" type="checkbox"/> -N
			Bat	Thread			E 973	N 608					<input type="checkbox"/> -Y / <input type="checkbox"/> -N	<input type="checkbox"/> -Y / <input type="checkbox"/> -N
							E	N					<input type="checkbox"/> -Y / <input type="checkbox"/> -N	<input type="checkbox"/> -Y / <input type="checkbox"/> -N
17	7:30am	n/a	Mourning Dove	Black Thread	Thawed	17	E 0444	N 4765	46	NE	dirt / grass	2	<input checked="" type="checkbox"/> -Y / <input type="checkbox"/> -N	<input type="checkbox"/> -Y / <input checked="" type="checkbox"/> -N
							E 551	N 089					<input type="checkbox"/> -Y / <input type="checkbox"/> -N	<input type="checkbox"/> -Y / <input type="checkbox"/> -N
							E	N					<input type="checkbox"/> -Y / <input type="checkbox"/> -N	<input type="checkbox"/> -Y / <input type="checkbox"/> -N
22	7:50am	n/a	Bird (small)	White	Thawed	17	E 0438	N 4763	21	S	dirt	1	<input checked="" type="checkbox"/> -Y / <input type="checkbox"/> -N	<input type="checkbox"/> -Y / <input checked="" type="checkbox"/> -N
			Black and White	tag			E 306	N 190			(dry)		<input type="checkbox"/> -Y / <input type="checkbox"/> -N	<input type="checkbox"/> -Y / <input type="checkbox"/> -N
							E	N					<input type="checkbox"/> -Y / <input type="checkbox"/> -N	<input type="checkbox"/> -Y / <input type="checkbox"/> -N
						E	N					<input type="checkbox"/> -Y / <input type="checkbox"/> -N	<input type="checkbox"/> -Y / <input type="checkbox"/> -N	
						E	N					<input type="checkbox"/> -Y / <input type="checkbox"/> -N	<input type="checkbox"/> -Y / <input type="checkbox"/> -N	
						E	N					<input type="checkbox"/> -Y / <input type="checkbox"/> -N	<input type="checkbox"/> -Y / <input type="checkbox"/> -N	
						E	N					<input type="checkbox"/> -Y / <input type="checkbox"/> -N	<input type="checkbox"/> -Y / <input type="checkbox"/> -N	
						E	N					<input type="checkbox"/> -Y / <input type="checkbox"/> -N	<input type="checkbox"/> -Y / <input type="checkbox"/> -N	
						E	N					<input type="checkbox"/> -Y / <input type="checkbox"/> -N	<input type="checkbox"/> -Y / <input type="checkbox"/> -N	
						E	N					<input type="checkbox"/> -Y / <input type="checkbox"/> -N	<input type="checkbox"/> -Y / <input type="checkbox"/> -N	
						E	N					<input type="checkbox"/> -Y / <input type="checkbox"/> -N	<input type="checkbox"/> -Y / <input type="checkbox"/> -N	

PAGE 1 OF 1

Print Name & Initial: Anna Corrigan (field notes author)

Quality Control:

Print Name & Initial: Andrew Tylan A.T. (field notes Q/QC personnel)

This form is complete  & legible

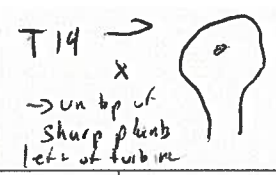
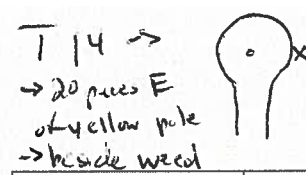
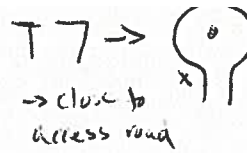

Project No: 160961010 Project Name: Adelaide Wind Farm  
 Date: May 14, 2015 Field Personnel: Ken Edwards  
 TESTER: Anna Corrigan

Weather Conditions: 1-3 TEMP (°C) 3-5 km/h WIND 1 ESE CLOUD 10% PPT 0 PPT (last 24-hrs) 0  
 (speed / direction)

% VEG. COVER	VEG. HEIGHT	VISIBILITY CLASS*
≥ 90% bare ground	≤ 15cm tall	Class 1 (Easy)
≥ 25% bare ground	≤ 15cm tall	Class 2 (Moderate)
≤ 25% bare ground	≤ 25% > 30cm tall	Class 3 (Difficult)
Little/no bare ground	≥ 25% > 30cm tall	Class 4 (Very difficult)

Turbine No.	Time Placed	Time Collected	Species	Marker Used	Condition frozen/thawed	UTM Coordinates			Position from turbine		Substrate	Visibility Class*	Detected?	Scavenged?		
						Zone	Easting	Northing	Dist. (m)	Direction						
7	7:10	16:00	Silver-haired Bat	Flagging Tape (diskette)	Thawed	17	E 0449	N 4762	18	WNW	Dirt	1	<input checked="" type="checkbox"/> -Y/ <input checked="" type="checkbox"/> -N	<input checked="" type="checkbox"/> -Y/ <input checked="" type="checkbox"/> -N		
							E 041	N 154							<input type="checkbox"/> -Y/ <input type="checkbox"/> -N	<input type="checkbox"/> -Y/ <input type="checkbox"/> -N
							E	N							<input type="checkbox"/> -Y/ <input type="checkbox"/> -N	<input type="checkbox"/> -Y/ <input type="checkbox"/> -N
14	7:30	n/a	Heavy Bat	Flagging Tape (diskette)	Thawed	17	E 0447	N 4764	16	ENE	Dirt	1	<input checked="" type="checkbox"/> -Y/ <input type="checkbox"/> -N	<input checked="" type="checkbox"/> -Y/ <input checked="" type="checkbox"/> -N		
							E 183	N 863							<input type="checkbox"/> -Y/ <input type="checkbox"/> -N	<input type="checkbox"/> -Y/ <input type="checkbox"/> -N
							E	N							<input type="checkbox"/> -Y/ <input type="checkbox"/> -N	<input type="checkbox"/> -Y/ <input type="checkbox"/> -N
19	7:45	n/a	White-breasted Nuthatch	White Label	Thawed	17	E 0442	N 4764	41	SE	Weeds	2	<input checked="" type="checkbox"/> -Y/ <input checked="" type="checkbox"/> -N	<input checked="" type="checkbox"/> -Y/ <input checked="" type="checkbox"/> -N		
							E 949	N 930							<input type="checkbox"/> -Y/ <input type="checkbox"/> -N	<input type="checkbox"/> -Y/ <input type="checkbox"/> -N
							E	N							<input type="checkbox"/> -Y/ <input type="checkbox"/> -N	<input type="checkbox"/> -Y/ <input type="checkbox"/> -N
												<input type="checkbox"/> -Y/ <input type="checkbox"/> -N	<input type="checkbox"/> -Y/ <input type="checkbox"/> -N			
												<input type="checkbox"/> -Y/ <input type="checkbox"/> -N	<input type="checkbox"/> -Y/ <input type="checkbox"/> -N			
												<input type="checkbox"/> -Y/ <input type="checkbox"/> -N	<input type="checkbox"/> -Y/ <input type="checkbox"/> -N			
												<input type="checkbox"/> -Y/ <input type="checkbox"/> -N	<input type="checkbox"/> -Y/ <input type="checkbox"/> -N			
												<input type="checkbox"/> -Y/ <input type="checkbox"/> -N	<input type="checkbox"/> -Y/ <input type="checkbox"/> -N			
												<input type="checkbox"/> -Y/ <input type="checkbox"/> -N	<input type="checkbox"/> -Y/ <input type="checkbox"/> -N			
												<input type="checkbox"/> -Y/ <input type="checkbox"/> -N	<input type="checkbox"/> -Y/ <input type="checkbox"/> -N			
												<input type="checkbox"/> -Y/ <input type="checkbox"/> -N	<input type="checkbox"/> -Y/ <input type="checkbox"/> -N			
												<input type="checkbox"/> -Y/ <input type="checkbox"/> -N	<input type="checkbox"/> -Y/ <input type="checkbox"/> -N			
												<input type="checkbox"/> -Y/ <input type="checkbox"/> -N	<input type="checkbox"/> -Y/ <input type="checkbox"/> -N			

PAGE 1 OF 1  
 Print Name & Initial: Anna Corrigan  
 (field notes author)

Quality Control: This form is complete  & legible   
 Print Name & Initial: Andrew Tyler A.T.  
 (field notes Q/QC personnel)

**Searcher Efficiency Record Form**

Project No: 160961010 Project Name: Adelaide Wind Farm  
 Date: May 28, 2015 Field Personnel: Ken Edwards  
 TESTER: Anna Corrigan

Weather Conditions: 13-15 2km/h W 10% ☉ Thunderstorms  
 TEMP (°C) WIND (speed / direction) CLOUD PPT PPT (last 24-hrs)

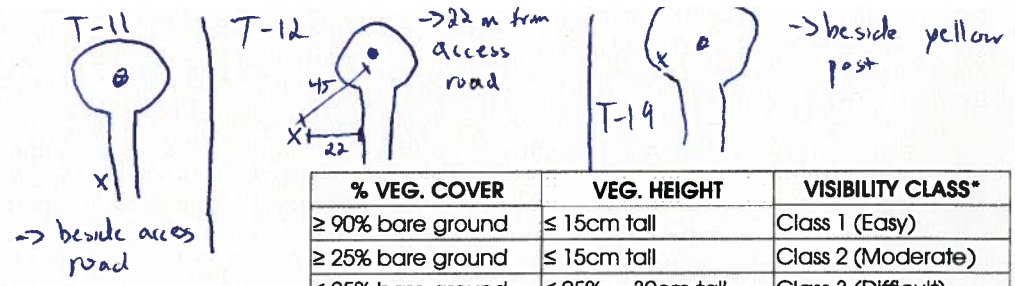

% VEG. COVER	VEG. HEIGHT	VISIBILITY CLASS*
≥ 90% bare ground	≤ 15cm tall	Class 1 (Easy)
≥ 25% bare ground	≤ 15cm tall	Class 2 (Moderate)
≤ 25% bare ground	≤ 25% > 30cm tall	Class 3 (Difficult)
Little/no bare ground	≥ 25% > 30cm tall	Class 4 (Very difficult)

Turbine No.	Time Placed	Time Collected	Species	Marker Used	Condition frozen/thawed	UTM Coordinates			Position from turbine		Substrate	Visibility Class*	Detected?	Scavenged?
						Zone	Easting	Northing	Dist. (m)	Direction				
11	7:10am	N/A	Northern Rough-winged Swallow	Flagging Tape	Thawed	17	E 044	N 4763	45	E	Dirt	1	<input checked="" type="checkbox"/> Y / <input type="checkbox"/> N	<input type="checkbox"/> Y / <input checked="" type="checkbox"/> N
							E 9210	N 634					<input type="checkbox"/> Y / <input type="checkbox"/> N	<input type="checkbox"/> Y / <input type="checkbox"/> N
							E	N					<input type="checkbox"/> Y / <input type="checkbox"/> N	<input type="checkbox"/> Y / <input type="checkbox"/> N
12	7:25am	7:00 on June 1, 2015	European Starling	Flagging Tape	Thawed	17	E 044	N 4763	40	NW	Weeds	2	<input type="checkbox"/> Y / <input checked="" type="checkbox"/> N	<input type="checkbox"/> Y / <input checked="" type="checkbox"/> N
							E 7354	N 385					<input type="checkbox"/> Y / <input type="checkbox"/> N	<input type="checkbox"/> Y / <input type="checkbox"/> N
							E	N					<input type="checkbox"/> Y / <input type="checkbox"/> N	<input type="checkbox"/> Y / <input type="checkbox"/> N
19	7:40	N/A	Silver-haired Bat	Flagging Tape	Thawed	17	E 044	N 4764	2.5	SSE	Gravel	1	<input checked="" type="checkbox"/> Y / <input type="checkbox"/> N	<input type="checkbox"/> Y / <input checked="" type="checkbox"/> N
							E 2953	N 964					<input type="checkbox"/> Y / <input type="checkbox"/> N	<input type="checkbox"/> Y / <input type="checkbox"/> N
							E	N					<input type="checkbox"/> Y / <input type="checkbox"/> N	<input type="checkbox"/> Y / <input type="checkbox"/> N
						E	N					<input type="checkbox"/> Y / <input type="checkbox"/> N	<input type="checkbox"/> Y / <input type="checkbox"/> N	
						E	N					<input type="checkbox"/> Y / <input type="checkbox"/> N	<input type="checkbox"/> Y / <input type="checkbox"/> N	
						E	N					<input type="checkbox"/> Y / <input type="checkbox"/> N	<input type="checkbox"/> Y / <input type="checkbox"/> N	
						E	N					<input type="checkbox"/> Y / <input type="checkbox"/> N	<input type="checkbox"/> Y / <input type="checkbox"/> N	
						E	N					<input type="checkbox"/> Y / <input type="checkbox"/> N	<input type="checkbox"/> Y / <input type="checkbox"/> N	
						E	N					<input type="checkbox"/> Y / <input type="checkbox"/> N	<input type="checkbox"/> Y / <input type="checkbox"/> N	
						E	N					<input type="checkbox"/> Y / <input type="checkbox"/> N	<input type="checkbox"/> Y / <input type="checkbox"/> N	
						E	N					<input type="checkbox"/> Y / <input type="checkbox"/> N	<input type="checkbox"/> Y / <input type="checkbox"/> N	

Print Name & Initial: Anna Corrigan  
 (field notes author)

Quality Control: This form is complete  & legible   
 Print Name & Initial: Andrew Taylor A.T.  
 (field notes QA/QC personnel)

**Searcher Efficiency Record Form**

Project No: 160961010 Project Name: Adelaide Wind Farm

Date: June 1, 2015 Field Personnel: Ken Edwards

TESTER: Anna Corrigan

Weather Conditions: 7 TEMP (°C) 11km/h / N WIND (speed / direction) 20% CLOUD Ø PPT Rain PPT (last 24-hrs)

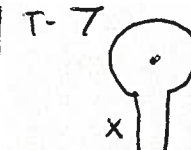
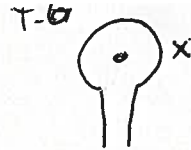
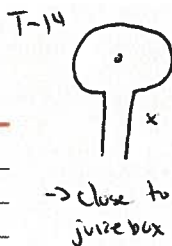

→ beside huge puddle

% VEG. COVER	VEG. HEIGHT	VISIBILITY CLASS*
≥ 90% bare ground	≤ 15cm tall	Class 1 (Easy)
≥ 25% bare ground	≤ 15cm tall	Class 2 (Moderate)
≤ 25% bare ground	≤ 25% > 30cm tall	Class 3 (Difficult)
Little/no bare ground	≥ 25% > 30cm tall	Class 4 (Very difficult)

Turbine No.	Time Placed	Time Collected	Species	Marker Used	Condition frozen/thawed	UTM Coordinates			Position from turbine		Substrate	Visibility Class*	Detected?	Scavenged?
						Zone	Easting	Northing	Dist. (m)	Direction				
14*	7:15		Bird (Brown + White)	Tape	Thawed	17	E 044	N 4765	20	E	dirt	1	<input checked="" type="checkbox"/> -Y/ <input checked="" type="checkbox"/> -N	<input checked="" type="checkbox"/> -Y/ <input checked="" type="checkbox"/> -N
							E 6119	N 011					<input type="checkbox"/> -Y/ <input type="checkbox"/> -N	<input type="checkbox"/> -Y/ <input type="checkbox"/> -N
							E	N					<input type="checkbox"/> -Y/ <input type="checkbox"/> -N	<input type="checkbox"/> -Y/ <input type="checkbox"/> -N
6	7:30	n/a	White-breasted Nuthatch	Tape	Thawed	17	E 045	N 4762	5	E	weeds	2	<input checked="" type="checkbox"/> -Y/ <input type="checkbox"/> -N	<input checked="" type="checkbox"/> -Y/ <input type="checkbox"/> -N
							E 1984	N 608					<input type="checkbox"/> -Y/ <input type="checkbox"/> -N	<input type="checkbox"/> -Y/ <input type="checkbox"/> -N
							E	N					<input type="checkbox"/> -Y/ <input type="checkbox"/> -N	<input type="checkbox"/> -Y/ <input type="checkbox"/> -N
7	7:45	17:30	Silver-haired Bat	Tape	Thawed	17	E 044	N 4762	28	W	Gravel	1	<input type="checkbox"/> -Y/ <input checked="" type="checkbox"/> -N	<input type="checkbox"/> -Y/ <input checked="" type="checkbox"/> -N
							E 9633	N 147					<input type="checkbox"/> -Y/ <input type="checkbox"/> -N	<input type="checkbox"/> -Y/ <input type="checkbox"/> -N
							E	N					<input type="checkbox"/> -Y/ <input type="checkbox"/> -N	<input type="checkbox"/> -Y/ <input type="checkbox"/> -N
* made a mistake and put carcass							E	N					<input type="checkbox"/> -Y/ <input type="checkbox"/> -N	<input type="checkbox"/> -Y/ <input type="checkbox"/> -N
↳ take this out of records							E	N					<input type="checkbox"/> -Y/ <input type="checkbox"/> -N	<input type="checkbox"/> -Y/ <input type="checkbox"/> -N
							E	N					<input type="checkbox"/> -Y/ <input type="checkbox"/> -N	<input type="checkbox"/> -Y/ <input type="checkbox"/> -N
							E	N					<input type="checkbox"/> -Y/ <input type="checkbox"/> -N	<input type="checkbox"/> -Y/ <input type="checkbox"/> -N
							E	N					<input type="checkbox"/> -Y/ <input type="checkbox"/> -N	<input type="checkbox"/> -Y/ <input type="checkbox"/> -N
							E	N					<input type="checkbox"/> -Y/ <input type="checkbox"/> -N	<input type="checkbox"/> -Y/ <input type="checkbox"/> -N
							E	N					<input type="checkbox"/> -Y/ <input type="checkbox"/> -N	<input type="checkbox"/> -Y/ <input type="checkbox"/> -N
							E	N					<input type="checkbox"/> -Y/ <input type="checkbox"/> -N	<input type="checkbox"/> -Y/ <input type="checkbox"/> -N
							E	N					<input type="checkbox"/> -Y/ <input type="checkbox"/> -N	<input type="checkbox"/> -Y/ <input type="checkbox"/> -N

**Searcher Efficiency Record Form**

Project No: 160961010 Project Name: Adelaide Wind Farm

Date: June 4, 2015 Field Personnel: Ken Edwards

TESTER: Anna Corrigan

Weather Conditions: 14°C TEMP (°C) 11km/h / SE WIND (speed / direction) 60% CLOUD 0 PPT 0 PPT (last 24-hrs)

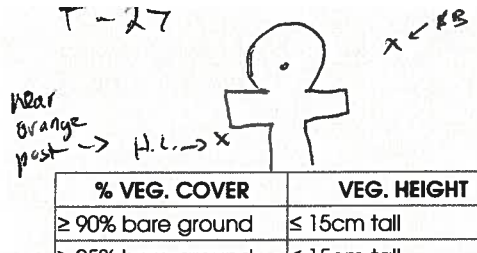

% VEG. COVER	VEG. HEIGHT	VISIBILITY CLASS*
≥ 90% bare ground	≤ 15cm tall	Class 1 (Easy)
≥ 25% bare ground	≤ 15cm tall	Class 2 (Moderate)
≤ 25% bare ground	≤ 25% > 30cm tall	Class 3 (Difficult)
Little/no bare ground	≥ 25% > 30cm tall	Class 4 (Very difficult)

Turbine No.	Time Placed	Time Collected	Species	Marker Used	Condition frozen/thawed	UTM Coordinates			Position from turbine		Substrate	Visibility Class*	Detected?	Scavenged?
						Zone	Easting	Northing	Dist. (m)	Direction				
20	7:15	n/a	Cliff Swallow	Flagging tape	thawed	17	E 0440	N 4765	31	S	Dirt	1	<input type="checkbox"/> -Y / <input checked="" type="checkbox"/> -N	<input type="checkbox"/> -Y / <input checked="" type="checkbox"/> -N
							E 264	N 196					<input type="checkbox"/> -Y / <input type="checkbox"/> -N	<input type="checkbox"/> -Y / <input type="checkbox"/> -N
							E	N					<input type="checkbox"/> -Y / <input type="checkbox"/> -N	<input type="checkbox"/> -Y / <input type="checkbox"/> -N
27	7:45	June 5 @ 12:00pm	Big Brown Bat	Pink Flagging Paper/white tape	thawed	17	E 0435	N 4765	24	N	Dirt/Veg	2	<input type="checkbox"/> -Y / <input checked="" type="checkbox"/> -N	<input checked="" type="checkbox"/> -Y / <input checked="" type="checkbox"/> -N
							E 963	N 492					<input type="checkbox"/> -Y / <input type="checkbox"/> -N	<input type="checkbox"/> -Y / <input type="checkbox"/> -N
							E	N					<input type="checkbox"/> -Y / <input type="checkbox"/> -N	<input type="checkbox"/> -Y / <input type="checkbox"/> -N
27	7:50	n/a	Horned Lark	Flagging Tape	thawed	17	E 0435	N 4765	20	SE	Dirt	1	<input checked="" type="checkbox"/> -Y / <input checked="" type="checkbox"/> -N	<input checked="" type="checkbox"/> -Y / <input type="checkbox"/> -N
							E 978	N 452					<input type="checkbox"/> -Y / <input type="checkbox"/> -N	<input type="checkbox"/> -Y / <input type="checkbox"/> -N
							E	N					<input type="checkbox"/> -Y / <input type="checkbox"/> -N	<input type="checkbox"/> -Y / <input type="checkbox"/> -N
							E	N					<input type="checkbox"/> -Y / <input type="checkbox"/> -N	<input type="checkbox"/> -Y / <input type="checkbox"/> -N
							E	N					<input type="checkbox"/> -Y / <input type="checkbox"/> -N	<input type="checkbox"/> -Y / <input type="checkbox"/> -N
							E	N					<input type="checkbox"/> -Y / <input type="checkbox"/> -N	<input type="checkbox"/> -Y / <input type="checkbox"/> -N
							E	N					<input type="checkbox"/> -Y / <input type="checkbox"/> -N	<input type="checkbox"/> -Y / <input type="checkbox"/> -N
							E	N					<input type="checkbox"/> -Y / <input type="checkbox"/> -N	<input type="checkbox"/> -Y / <input type="checkbox"/> -N
							E	N					<input type="checkbox"/> -Y / <input type="checkbox"/> -N	<input type="checkbox"/> -Y / <input type="checkbox"/> -N
							E	N					<input type="checkbox"/> -Y / <input type="checkbox"/> -N	<input type="checkbox"/> -Y / <input type="checkbox"/> -N
							E	N					<input type="checkbox"/> -Y / <input type="checkbox"/> -N	<input type="checkbox"/> -Y / <input type="checkbox"/> -N

PAGE 1 OF 1  
 Print Name & Initial: Anna Corrigan  
(field notes author)

Quality Control:  This form is complete & legible  
 Print Name & Initial: Andrew Taylor A.T.  
(field notes Q/QC personnel)

### Searcher Efficiency Record Form

Project No: 160961010 Project Name: Adelaide Wind Farm

Date: June 8th, 2015 Field Personnel: Ken Edwards

TESTER: Sam Soehn

Weather Conditions: 20°C 5 km/h N 100% none thunderstorm  
 TEMP (°C) ↑ to 10 WIND (speed / direction) CLOUD PPT PPT (last 24-hrs)

% VEG. COVER	VEG. HEIGHT	VISIBILITY CLASS*
≥ 90% bare ground	≤ 15cm tall	Class 1 (Easy)
≥ 25% bare ground	≤ 15cm tall	Class 2 (Moderate)
≤ 25% bare ground	≤ 25% > 30cm tall	Class 3 (Difficult)
Little/no bare ground	≥ 25% > 30cm tall	Class 4 (Very difficult)

Turbine No.	Time Placed	Time Collected	Species	Marker Used	Condition frozen/thawed	UTM Coordinates			Position from turbine		Substrate	Visibility Class*	Detected?	Scavenged?
						Zone	Easting	Northing	Dist. (m)	Direction				
6	7:00		hoary bat	scotch tape	thawed	17T	E0451975	N4762615	6	NW	weeds/crops	2	<input checked="" type="checkbox"/> -Y/ <input type="checkbox"/> -N	<input type="checkbox"/> -Y/ <input checked="" type="checkbox"/> -N
12	7:15		bird	white sticker	thawed	17T	E0447848	N4763787	39	SW	dirt/weeds	2	<input type="checkbox"/> -Y/ <input checked="" type="checkbox"/> -N	<input checked="" type="checkbox"/> -Y/ <input type="checkbox"/> -N
17	7:30		bird	scotch tape	thawed	17T	E0444538	N4765096	39	NE	dirt/weeds	2	<input checked="" type="checkbox"/> -Y/ <input type="checkbox"/> -N	<input type="checkbox"/> -Y/ <input checked="" type="checkbox"/> -N
						E		N					<input type="checkbox"/> -Y/ <input type="checkbox"/> -N	<input type="checkbox"/> -Y/ <input type="checkbox"/> -N
						E		N					<input type="checkbox"/> -Y/ <input type="checkbox"/> -N	<input type="checkbox"/> -Y/ <input type="checkbox"/> -N
						E		N					<input type="checkbox"/> -Y/ <input type="checkbox"/> -N	<input type="checkbox"/> -Y/ <input type="checkbox"/> -N
						E		N					<input type="checkbox"/> -Y/ <input type="checkbox"/> -N	<input type="checkbox"/> -Y/ <input type="checkbox"/> -N
						E		N					<input type="checkbox"/> -Y/ <input type="checkbox"/> -N	<input type="checkbox"/> -Y/ <input type="checkbox"/> -N
						E		N					<input type="checkbox"/> -Y/ <input type="checkbox"/> -N	<input type="checkbox"/> -Y/ <input type="checkbox"/> -N
						E		N					<input type="checkbox"/> -Y/ <input type="checkbox"/> -N	<input type="checkbox"/> -Y/ <input type="checkbox"/> -N
						E		N					<input type="checkbox"/> -Y/ <input type="checkbox"/> -N	<input type="checkbox"/> -Y/ <input type="checkbox"/> -N
						E		N					<input type="checkbox"/> -Y/ <input type="checkbox"/> -N	<input type="checkbox"/> -Y/ <input type="checkbox"/> -N
						E		N					<input type="checkbox"/> -Y/ <input type="checkbox"/> -N	<input type="checkbox"/> -Y/ <input type="checkbox"/> -N
						E		N					<input type="checkbox"/> -Y/ <input type="checkbox"/> -N	<input type="checkbox"/> -Y/ <input type="checkbox"/> -N
						E		N					<input type="checkbox"/> -Y/ <input type="checkbox"/> -N	<input type="checkbox"/> -Y/ <input type="checkbox"/> -N
						E		N					<input type="checkbox"/> -Y/ <input type="checkbox"/> -N	<input type="checkbox"/> -Y/ <input type="checkbox"/> -N
						E		N					<input type="checkbox"/> -Y/ <input type="checkbox"/> -N	<input type="checkbox"/> -Y/ <input type="checkbox"/> -N
						E		N					<input type="checkbox"/> -Y/ <input type="checkbox"/> -N	<input type="checkbox"/> -Y/ <input type="checkbox"/> -N
						E		N					<input type="checkbox"/> -Y/ <input type="checkbox"/> -N	<input type="checkbox"/> -Y/ <input type="checkbox"/> -N
						E		N					<input type="checkbox"/> -Y/ <input type="checkbox"/> -N	<input type="checkbox"/> -Y/ <input type="checkbox"/> -N
						E		N					<input type="checkbox"/> -Y/ <input type="checkbox"/> -N	<input type="checkbox"/> -Y/ <input type="checkbox"/> -N
						E		N					<input type="checkbox"/> -Y/ <input type="checkbox"/> -N	<input type="checkbox"/> -Y/ <input type="checkbox"/> -N

Print Name & Initial: Sam Soehn SS  
 (field notes author)

Quality Control: \_\_\_\_\_ This form is complete  & legible   
 Print Name & Initial: Andrew Tuder A.T.  
 (field notes QA/QC personnel)

### Searcher Efficiency Record Form

Project No: 160961010 Project Name: Adelaide Wind Farm

Date: June 22, 2015 Field Personnel: Ken Edwards

TESTER: Sam Soehn

Weather Conditions: <sup>03</sup> 19 1 / NE 10% none rain  
 TEMP (°C) ↑ to 3 WIND (speed / direction) CLOUD PPT PPT (last 24-hrs)

% VEG. COVER	VEG. HEIGHT	VISIBILITY CLASS*
≥ 90% bare ground	≤ 15cm tall	Class 1 (Easy)
≥ 25% bare ground	≤ 15cm tall	Class 2 (Moderate)
≤ 25% bare ground	≤ 25% > 30cm tall	Class 3 (Difficult)
Little/no bare ground	≥ 25% > 30cm tall	Class 4 (Very difficult)

Turbine No.	Time Placed	Time Collected	Species	Marker Used	Condition frozen/thawed	UTM Coordinates			Position from turbine		Substrate	Visibility Class*	Detected?	Scavenged?
						Zone	Easting	Northing	Dist. (m)	Direction				
<del>14</del>	<del>7:05</del>		<del>hoary bat</del>	<del>scotch tape</del>	<del>partially thawed</del>	<del>17T</del>	<del>E 0447138</del>	<del>N 4764894</del>	<del>47</del>	<del>NW</del>	<del>corn</del>	<del>2</del>	<del><input type="checkbox"/>-Y/<input type="checkbox"/>-N</del>	<del><input type="checkbox"/>-Y/<input type="checkbox"/>-N</del>
19	7:20		bird	scotch tape	thawed	17T	E 0442954	N 4764930	35	SE	soy	1	<input checked="" type="checkbox"/> -Y/ <input type="checkbox"/> -N	<input type="checkbox"/> -Y/ <input type="checkbox"/> -N
27	7:35		hoary bat	scotch tape	thawed	17T	E 0435959	N 4765466	6	W	rocks under turbine	1	<input type="checkbox"/> -Y/ <input checked="" type="checkbox"/> -N	<input checked="" type="checkbox"/> -Y/ <input type="checkbox"/> -N
						E		N					<input type="checkbox"/> -Y/ <input type="checkbox"/> -N	<input type="checkbox"/> -Y/ <input type="checkbox"/> -N
						E		N					<input type="checkbox"/> -Y/ <input type="checkbox"/> -N	<input type="checkbox"/> -Y/ <input type="checkbox"/> -N
- scratched - did not make it to turbine 14 for mortality survey						E		N					<input type="checkbox"/> -Y/ <input type="checkbox"/> -N	<input type="checkbox"/> -Y/ <input type="checkbox"/> -N
*not included in data						E		N					<input type="checkbox"/> -Y/ <input type="checkbox"/> -N	<input type="checkbox"/> -Y/ <input type="checkbox"/> -N
						E		N					<input type="checkbox"/> -Y/ <input type="checkbox"/> -N	<input type="checkbox"/> -Y/ <input type="checkbox"/> -N
						E		N					<input type="checkbox"/> -Y/ <input type="checkbox"/> -N	<input type="checkbox"/> -Y/ <input type="checkbox"/> -N
						E		N					<input type="checkbox"/> -Y/ <input type="checkbox"/> -N	<input type="checkbox"/> -Y/ <input type="checkbox"/> -N
						E		N					<input type="checkbox"/> -Y/ <input type="checkbox"/> -N	<input type="checkbox"/> -Y/ <input type="checkbox"/> -N
						E		N					<input type="checkbox"/> -Y/ <input type="checkbox"/> -N	<input type="checkbox"/> -Y/ <input type="checkbox"/> -N
						E		N					<input type="checkbox"/> -Y/ <input type="checkbox"/> -N	<input type="checkbox"/> -Y/ <input type="checkbox"/> -N
						E		N					<input type="checkbox"/> -Y/ <input type="checkbox"/> -N	<input type="checkbox"/> -Y/ <input type="checkbox"/> -N
						E		N					<input type="checkbox"/> -Y/ <input type="checkbox"/> -N	<input type="checkbox"/> -Y/ <input type="checkbox"/> -N
						E		N					<input type="checkbox"/> -Y/ <input type="checkbox"/> -N	<input type="checkbox"/> -Y/ <input type="checkbox"/> -N
						E		N					<input type="checkbox"/> -Y/ <input type="checkbox"/> -N	<input type="checkbox"/> -Y/ <input type="checkbox"/> -N

PAGE 1 OF 1

Print Name & Initial: Sam Soehn SS

(field notes author)

Quality Control:

Print Name & Initial: Andrew Taylor A.T.

(field notes QA/QC personnel)

This form is complete  & legible

### Searcher Efficiency Record Form

Project No: 160961010 Project Name: Adelaide Wind Farm

Date: June 25<sup>th</sup>, 2015 Field Personnel: Ken Edwards

TESTER: Sam Soehn

Weather Conditions: 15 3 NE 90% none none  
TEMP (°C) WIND (speed / direction) CLOUD PPT PPT (last 24-hrs)

% VEG. COVER	VEG. HEIGHT	VISIBILITY CLASS*
≥ 90% bare ground	≤ 15cm tall	Class 1 (Easy)
≥ 25% bare ground	≤ 15cm tall	Class 2 (Moderate)
≤ 25% bare ground	≤ 25% > 30cm tall	Class 3 (Difficult)
Little/no bare ground	≥ 25% > 30cm tall	Class 4 (Very difficult)

Turbine No.	Time Placed	Time Collected	Species	Marker Used	Condition <small>frozen/thawed</small>	UTM Coordinates			Position from turbine		Substrate	Visibility Class*	Detected?	Scavenged?
						Zone	Easting	Northing	Dist. (m)	Direction				
11	6:48	<u>June 26</u> <u>2:45</u>	bird	scotch tape	thawed	17T	E0449126	N4763604	25	SW	soy/ dirt	1	<input type="checkbox"/> -Y/ <input checked="" type="checkbox"/> -N	<input type="checkbox"/> -Y/ <input checked="" type="checkbox"/> -N
14	7:04	<u>June 26</u> <u>3:00</u>	hoary bat	scotch tape	thawed	17T	E0447185	N4764878	24	NE	soy/ weeds	2	<input type="checkbox"/> -Y/ <input checked="" type="checkbox"/> -N	<input type="checkbox"/> -Y/ <input checked="" type="checkbox"/> -N
22	7:22	<u>June 26</u> <u>3:20</u>	hoary bat	scotch tapes	thawed	17T	E0438296	N4763210	13	W	corn	2	<input type="checkbox"/> -Y/ <input checked="" type="checkbox"/> -N	<input type="checkbox"/> -Y/ <input checked="" type="checkbox"/> -N
							E	N					<input type="checkbox"/> -Y/ <input type="checkbox"/> -N	<input type="checkbox"/> -Y/ <input type="checkbox"/> -N
							E	N					<input type="checkbox"/> -Y/ <input type="checkbox"/> -N	<input type="checkbox"/> -Y/ <input type="checkbox"/> -N
							E	N					<input type="checkbox"/> -Y/ <input type="checkbox"/> -N	<input type="checkbox"/> -Y/ <input type="checkbox"/> -N
							E	N					<input type="checkbox"/> -Y/ <input type="checkbox"/> -N	<input type="checkbox"/> -Y/ <input type="checkbox"/> -N
							E	N					<input type="checkbox"/> -Y/ <input type="checkbox"/> -N	<input type="checkbox"/> -Y/ <input type="checkbox"/> -N
							E	N					<input type="checkbox"/> -Y/ <input type="checkbox"/> -N	<input type="checkbox"/> -Y/ <input type="checkbox"/> -N
							E	N					<input type="checkbox"/> -Y/ <input type="checkbox"/> -N	<input type="checkbox"/> -Y/ <input type="checkbox"/> -N
							E	N					<input type="checkbox"/> -Y/ <input type="checkbox"/> -N	<input type="checkbox"/> -Y/ <input type="checkbox"/> -N
							E	N					<input type="checkbox"/> -Y/ <input type="checkbox"/> -N	<input type="checkbox"/> -Y/ <input type="checkbox"/> -N
							E	N					<input type="checkbox"/> -Y/ <input type="checkbox"/> -N	<input type="checkbox"/> -Y/ <input type="checkbox"/> -N
							E	N					<input type="checkbox"/> -Y/ <input type="checkbox"/> -N	<input type="checkbox"/> -Y/ <input type="checkbox"/> -N
							E	N					<input type="checkbox"/> -Y/ <input type="checkbox"/> -N	<input type="checkbox"/> -Y/ <input type="checkbox"/> -N
							E	N					<input type="checkbox"/> -Y/ <input type="checkbox"/> -N	<input type="checkbox"/> -Y/ <input type="checkbox"/> -N
							E	N					<input type="checkbox"/> -Y/ <input type="checkbox"/> -N	<input type="checkbox"/> -Y/ <input type="checkbox"/> -N
							E	N					<input type="checkbox"/> -Y/ <input type="checkbox"/> -N	<input type="checkbox"/> -Y/ <input type="checkbox"/> -N
							E	N					<input type="checkbox"/> -Y/ <input type="checkbox"/> -N	<input type="checkbox"/> -Y/ <input type="checkbox"/> -N
							E	N					<input type="checkbox"/> -Y/ <input type="checkbox"/> -N	<input type="checkbox"/> -Y/ <input type="checkbox"/> -N
							E	N					<input type="checkbox"/> -Y/ <input type="checkbox"/> -N	<input type="checkbox"/> -Y/ <input type="checkbox"/> -N
							E	N					<input type="checkbox"/> -Y/ <input type="checkbox"/> -N	<input type="checkbox"/> -Y/ <input type="checkbox"/> -N

PAGE 1 OF 1  
 Print Name & Initial: Sam Soehn SS  
(field notes author)

Quality Control: \_\_\_\_\_ This form is complete  & legible   
 Print Name & Initial: Andrew Taylor A.T.  
(field notes QA/QC personnel)



### Searcher Efficiency Record Form

Project No: 160961010 Project Name: Adelaide Wind Farm

Date: June 29, 2015 Field Personnel: Ken Edwards

TESTER: Sam Soehn

Weather Conditions: 13 TEMP (°C) 3, NW WIND (speed / direction) 50% CLOUD none PPT rain PPT (last 24-hrs)

% VEG. COVER	VEG. HEIGHT	VISIBILITY CLASS*
≥ 90% bare ground	≤ 15cm tall	Class 1 (Easy)
≥ 25% bare ground	≤ 15cm tall	Class 2 (Moderate)
≤ 25% bare ground	≤ 25% > 30cm tall	Class 3 (Difficult)
Little/no bare ground	≥ 25% > 30cm tall	Class 4 (Very difficult)

Turbine No.	Time Placed	Time Collected	Species	Marker Used	Condition frozen/thawed	UTM Coordinates			Position from turbine		Substrate	Visibility Class*	Detected?	Scavenged?
						Zone	Easting	Northing	Dist. (m)	Direction				
7	7:07	n/a	bat	Scotch tape	thawed	17T	E0449686	N4762167	36	NE	soy	2	<input checked="" type="checkbox"/> -Y / <input type="checkbox"/> -N	<input type="checkbox"/> -Y / <input checked="" type="checkbox"/> -N
14	7:38	n/a	bird	white sticker	thawed	17T	E0447130	N4764856	40	W	corn	2	<input checked="" type="checkbox"/> -Y / <input type="checkbox"/> -N	<input type="checkbox"/> -Y / <input checked="" type="checkbox"/> -N
20	7:52	n/a	bat	Scotch tape	thawed	17T	E0440259	N4765237	13	NE	dirt	1	<input checked="" type="checkbox"/> -Y / <input type="checkbox"/> -N	<input type="checkbox"/> -Y / <input checked="" type="checkbox"/> -N
						E		N					<input type="checkbox"/> -Y / <input type="checkbox"/> -N	<input type="checkbox"/> -Y / <input type="checkbox"/> -N
						E		N					<input type="checkbox"/> -Y / <input type="checkbox"/> -N	<input type="checkbox"/> -Y / <input type="checkbox"/> -N
						E		N					<input type="checkbox"/> -Y / <input type="checkbox"/> -N	<input type="checkbox"/> -Y / <input type="checkbox"/> -N
						E		N					<input type="checkbox"/> -Y / <input type="checkbox"/> -N	<input type="checkbox"/> -Y / <input type="checkbox"/> -N
						E		N					<input type="checkbox"/> -Y / <input type="checkbox"/> -N	<input type="checkbox"/> -Y / <input type="checkbox"/> -N
						E		N					<input type="checkbox"/> -Y / <input type="checkbox"/> -N	<input type="checkbox"/> -Y / <input type="checkbox"/> -N
						E		N					<input type="checkbox"/> -Y / <input type="checkbox"/> -N	<input type="checkbox"/> -Y / <input type="checkbox"/> -N
						E		N					<input type="checkbox"/> -Y / <input type="checkbox"/> -N	<input type="checkbox"/> -Y / <input type="checkbox"/> -N
						E		N					<input type="checkbox"/> -Y / <input type="checkbox"/> -N	<input type="checkbox"/> -Y / <input type="checkbox"/> -N
						E		N					<input type="checkbox"/> -Y / <input type="checkbox"/> -N	<input type="checkbox"/> -Y / <input type="checkbox"/> -N
						E		N					<input type="checkbox"/> -Y / <input type="checkbox"/> -N	<input type="checkbox"/> -Y / <input type="checkbox"/> -N
						E		N					<input type="checkbox"/> -Y / <input type="checkbox"/> -N	<input type="checkbox"/> -Y / <input type="checkbox"/> -N
						E		N					<input type="checkbox"/> -Y / <input type="checkbox"/> -N	<input type="checkbox"/> -Y / <input type="checkbox"/> -N
						E		N					<input type="checkbox"/> -Y / <input type="checkbox"/> -N	<input type="checkbox"/> -Y / <input type="checkbox"/> -N
						E		N					<input type="checkbox"/> -Y / <input type="checkbox"/> -N	<input type="checkbox"/> -Y / <input type="checkbox"/> -N
						E		N					<input type="checkbox"/> -Y / <input type="checkbox"/> -N	<input type="checkbox"/> -Y / <input type="checkbox"/> -N
						E		N					<input type="checkbox"/> -Y / <input type="checkbox"/> -N	<input type="checkbox"/> -Y / <input type="checkbox"/> -N
						E		N					<input type="checkbox"/> -Y / <input type="checkbox"/> -N	<input type="checkbox"/> -Y / <input type="checkbox"/> -N
						E		N					<input type="checkbox"/> -Y / <input type="checkbox"/> -N	<input type="checkbox"/> -Y / <input type="checkbox"/> -N

PAGE 1 OF 1  
 Print Name & Initial: Sam Soehn SS  
 (field notes author)

Quality Control: \_\_\_\_\_ This form is complete  & legible   
 Print Name & Initial: Andrew Taylor A.T.  
 (field notes QA/QC personnel)

### Searcher Efficiency Record Form

Project No: 160961010      Project Name: Adelaide Wind Farm

Date: July 9, 2015      Field Personnel: Ken Edwards

TESTER: Sam Soehn

Weather Conditions: 15 TEMP (°C)      5 WIND (speed / direction) / NW  
100% CLOUD      None PPT      None PPT (last 24-hrs)  
*Drizzle - light rain*      *Drizzle*

% VEG. COVER	VEG. HEIGHT	VISIBILITY CLASS*
≥ 90% bare ground	≤ 15cm tall	Class 1 (Easy)
≥ 25% bare ground	≤ 15cm tall	Class 2 (Moderate)
≤ 25% bare ground	≤ 25% > 30cm tall	Class 3 (Difficult)
Little/no bare ground	≥ 25% > 30cm tall	Class 4 (Very difficult)

Turbine No.	Time Placed	Time Collected	Species	Marker Used	Condition frozen/thawed	UTM Coordinates			Position from turbine		Substrate	Visibility Class*	Detected?	Scavenged?
						Zone	Easting	Northing	Dist. (m)	Direction				
11	6:57	n/a	bat	scotch tape	thawed	17T	E0449172	N4763600	33	SE	soy	1	<input checked="" type="checkbox"/> -Y/ <input type="checkbox"/> -N	<input type="checkbox"/> -Y/ <input type="checkbox"/> -N
12	7:09	n/a	bird	white sticker	thawed	17T	E0447911	N4763356	35	SE	weeds	2	<input type="checkbox"/> -Y/ <input checked="" type="checkbox"/> -N	<input checked="" type="checkbox"/> -Y/ <input type="checkbox"/> -N
<del>27</del>	<del>7:26</del>		<del>cliff swallow</del>	<del>scotch tape</del>	<del>thawed</del>	<del>17T</del>	<del>E0435954</del>	<del>N4765482</del>	<del>18</del>	<del>NW</del>	<del>ploughed field</del>	<del>4</del>	<del><input type="checkbox"/>-Y/<input type="checkbox"/>-N</del>	<del><input type="checkbox"/>-Y/<input type="checkbox"/>-N</del>
→ Field was ploughed before able to search - scratched - not included in data						E	N						<input type="checkbox"/> -Y/ <input type="checkbox"/> -N	<input type="checkbox"/> -Y/ <input type="checkbox"/> -N
						E	N						<input type="checkbox"/> -Y/ <input type="checkbox"/> -N	<input type="checkbox"/> -Y/ <input type="checkbox"/> -N
						E	N						<input type="checkbox"/> -Y/ <input type="checkbox"/> -N	<input type="checkbox"/> -Y/ <input type="checkbox"/> -N
						E	N						<input type="checkbox"/> -Y/ <input type="checkbox"/> -N	<input type="checkbox"/> -Y/ <input type="checkbox"/> -N
						E	N						<input type="checkbox"/> -Y/ <input type="checkbox"/> -N	<input type="checkbox"/> -Y/ <input type="checkbox"/> -N
						E	N						<input type="checkbox"/> -Y/ <input type="checkbox"/> -N	<input type="checkbox"/> -Y/ <input type="checkbox"/> -N
						E	N						<input type="checkbox"/> -Y/ <input type="checkbox"/> -N	<input type="checkbox"/> -Y/ <input type="checkbox"/> -N
						E	N						<input type="checkbox"/> -Y/ <input type="checkbox"/> -N	<input type="checkbox"/> -Y/ <input type="checkbox"/> -N
						E	N						<input type="checkbox"/> -Y/ <input type="checkbox"/> -N	<input type="checkbox"/> -Y/ <input type="checkbox"/> -N
						E	N						<input type="checkbox"/> -Y/ <input type="checkbox"/> -N	<input type="checkbox"/> -Y/ <input type="checkbox"/> -N
						E	N						<input type="checkbox"/> -Y/ <input type="checkbox"/> -N	<input type="checkbox"/> -Y/ <input type="checkbox"/> -N
						E	N						<input type="checkbox"/> -Y/ <input type="checkbox"/> -N	<input type="checkbox"/> -Y/ <input type="checkbox"/> -N
						E	N						<input type="checkbox"/> -Y/ <input type="checkbox"/> -N	<input type="checkbox"/> -Y/ <input type="checkbox"/> -N

PAGE 1 OF 1  
 Print Name & Initial: Sam Soehn SS  
 (field notes author)

Quality Control: \_\_\_\_\_ This form is complete  & legible   
 Print Name & Initial: Andrew Taylor  
 (field notes QA/QC personnel)

### Searcher Efficiency Record Form

Project No: 160961010 Project Name: Adelaide Wind Farm  
 Date: July 16, 2015 Field Personnel: Ken Edwards  
 TESTER: Sam Soehn  
 Weather Conditions: <sup>5%  
f</sup> 15-16 1 WNW 5% None None  
TEMP (°C) WIND (speed / direction) CLOUD PPT PPT (last 24-hrs)

% VEG. COVER	VEG. HEIGHT	VISIBILITY CLASS*
≥ 90% bare ground	≤ 15cm tall	Class 1 (Easy)
≥ 25% bare ground	≤ 15cm tall	Class 2 (Moderate)
≤ 25% bare ground	≤ 25% > 30cm tall	Class 3 (Difficult)
Little/no bare ground	≥ 25% > 30cm tall	Class 4 (Very difficult)

Turbine No.	Time Placed	Time Collected	Species	Marker Used	Condition frozen/thawed	UTM Coordinates			Position from turbine		Substrate	Visibility Class*	Detected?	Scavenged?
						Zone	Easting	Northing	Dist. (m)	Direction				
17	7:40	n/a	mourning dove	scotch tape	frozen	17T	E0444515	N4765107	40	NE	weeds	2	<input type="checkbox"/> -Y/ <input checked="" type="checkbox"/> N	<input checked="" type="checkbox"/> -Y/ <input type="checkbox"/> -N
22	8:00	n/a	bird	white sticker	frozen	17T	E0438332	N4763242	38	NE	ploughed dirt	2	<input checked="" type="checkbox"/> -Y/ <input type="checkbox"/> -N	<input type="checkbox"/> -Y/ <input checked="" type="checkbox"/> -N
27	8:09	6:20	big brown bat	scotch tape	frozen	17T	E0435958	N4765457	12	SW	ploughed dirt	1	<input type="checkbox"/> -Y/ <input checked="" type="checkbox"/> N	<input type="checkbox"/> -Y/ <input checked="" type="checkbox"/> -N
						E		N					<input type="checkbox"/> -Y/ <input type="checkbox"/> -N	<input type="checkbox"/> -Y/ <input type="checkbox"/> -N
						E		N					<input type="checkbox"/> -Y/ <input type="checkbox"/> -N	<input type="checkbox"/> -Y/ <input type="checkbox"/> -N
						E		N					<input type="checkbox"/> -Y/ <input type="checkbox"/> -N	<input type="checkbox"/> -Y/ <input type="checkbox"/> -N
						E		N					<input type="checkbox"/> -Y/ <input type="checkbox"/> -N	<input type="checkbox"/> -Y/ <input type="checkbox"/> -N
						E		N					<input type="checkbox"/> -Y/ <input type="checkbox"/> -N	<input type="checkbox"/> -Y/ <input type="checkbox"/> -N
						E		N					<input type="checkbox"/> -Y/ <input type="checkbox"/> -N	<input type="checkbox"/> -Y/ <input type="checkbox"/> -N
						E		N					<input type="checkbox"/> -Y/ <input type="checkbox"/> -N	<input type="checkbox"/> -Y/ <input type="checkbox"/> -N
						E		N					<input type="checkbox"/> -Y/ <input type="checkbox"/> -N	<input type="checkbox"/> -Y/ <input type="checkbox"/> -N
						E		N					<input type="checkbox"/> -Y/ <input type="checkbox"/> -N	<input type="checkbox"/> -Y/ <input type="checkbox"/> -N
						E		N					<input type="checkbox"/> -Y/ <input type="checkbox"/> -N	<input type="checkbox"/> -Y/ <input type="checkbox"/> -N
						E		N					<input type="checkbox"/> -Y/ <input type="checkbox"/> -N	<input type="checkbox"/> -Y/ <input type="checkbox"/> -N
						E		N					<input type="checkbox"/> -Y/ <input type="checkbox"/> -N	<input type="checkbox"/> -Y/ <input type="checkbox"/> -N
						E		N					<input type="checkbox"/> -Y/ <input type="checkbox"/> -N	<input type="checkbox"/> -Y/ <input type="checkbox"/> -N
						E		N					<input type="checkbox"/> -Y/ <input type="checkbox"/> -N	<input type="checkbox"/> -Y/ <input type="checkbox"/> -N
						E		N					<input type="checkbox"/> -Y/ <input type="checkbox"/> -N	<input type="checkbox"/> -Y/ <input type="checkbox"/> -N
						E		N					<input type="checkbox"/> -Y/ <input type="checkbox"/> -N	<input type="checkbox"/> -Y/ <input type="checkbox"/> -N
						E		N					<input type="checkbox"/> -Y/ <input type="checkbox"/> -N	<input type="checkbox"/> -Y/ <input type="checkbox"/> -N
						E		N					<input type="checkbox"/> -Y/ <input type="checkbox"/> -N	<input type="checkbox"/> -Y/ <input type="checkbox"/> -N
						E		N					<input type="checkbox"/> -Y/ <input type="checkbox"/> -N	<input type="checkbox"/> -Y/ <input type="checkbox"/> -N

PAGE 1 OF 1  
 Print Name & Initial: Sam Soehn SS  
(field notes author)

Quality Control: \_\_\_\_\_ This form is complete  & legible   
 Print Name & Initial: Andrew Taylor Ait  
(field notes QA/QC personnel)



**Searcher Efficiency  
Record Form**

Project No: 160961010 Project Name: Adelaide Wind Farm

Date: July 23, 2015 Field Personnel: Ken Edwards

TESTER: Anna Corrigan

Weather: 13-16°C | 1km/h SE | 20% | 0 | 0  
Conditions: TEMP (°C) WIND CLOUD PPT PPT (last 24-hrs)

% VEG. COVER	VEG. HEIGHT	VISIBILITY CLASS*
≥ 90% bare ground	≤ 15cm tall	Class 1 (Easy)
≥ 25% bare ground	≤ 15cm tall	Class 2 (Moderate)
≤ 25% bare ground	≤ 25% > 30cm tall	Class 3 (Difficult)
Little/no bare ground	≥ 25% > 30cm tall	Class 4 (Very difficult)

Turbine No.	Time Placed	Time Collected	Species	Marker Used	Condition frozen/thawed	UTM Coordinates			Position from turbine		Substrate	Visibility Class*	Detected?	Scavenged?
						Zone	Easting	Northing	Dist. (m)	Direction				
7	7:00am	N/A	Juvenile AMRD	Orange Flagging Tape	Thawed	17	449661	4762154	19	N	Dirt	1	<input checked="" type="checkbox"/> -Y / <input type="checkbox"/> -N	<input type="checkbox"/> -Y / <input type="checkbox"/> -N
													<input type="checkbox"/> -Y / <input type="checkbox"/> -N	<input type="checkbox"/> -Y / <input type="checkbox"/> -N
													<input type="checkbox"/> -Y / <input type="checkbox"/> -N	<input type="checkbox"/> -Y / <input type="checkbox"/> -N
6	7:10am	5:15pm	Silver-haired Bat	Pink Paper Clip	Thawed	17	451971	4762604	6	WSW	weeds	2	<input type="checkbox"/> -Y / <input checked="" type="checkbox"/> -N	<input type="checkbox"/> -Y / <input type="checkbox"/> -N
													<input type="checkbox"/> -Y / <input type="checkbox"/> -N	<input type="checkbox"/> -Y / <input type="checkbox"/> -N
													<input type="checkbox"/> -Y / <input type="checkbox"/> -N	<input type="checkbox"/> -Y / <input type="checkbox"/> -N
17	7:30am	5:30pm	Eastern Red Bat	Masking Tape	Thawed	17	444508	4765055	8	WSW	Weeds	2	<input type="checkbox"/> -Y / <input checked="" type="checkbox"/> -N	<input type="checkbox"/> -Y / <input checked="" type="checkbox"/> -N
													<input type="checkbox"/> -Y / <input type="checkbox"/> -N	<input type="checkbox"/> -Y / <input type="checkbox"/> -N
													<input type="checkbox"/> -Y / <input type="checkbox"/> -N	<input type="checkbox"/> -Y / <input type="checkbox"/> -N
													<input type="checkbox"/> -Y / <input type="checkbox"/> -N	<input type="checkbox"/> -Y / <input type="checkbox"/> -N
													<input type="checkbox"/> -Y / <input type="checkbox"/> -N	<input type="checkbox"/> -Y / <input type="checkbox"/> -N
													<input type="checkbox"/> -Y / <input type="checkbox"/> -N	<input type="checkbox"/> -Y / <input type="checkbox"/> -N
													<input type="checkbox"/> -Y / <input type="checkbox"/> -N	<input type="checkbox"/> -Y / <input type="checkbox"/> -N
													<input type="checkbox"/> -Y / <input type="checkbox"/> -N	<input type="checkbox"/> -Y / <input type="checkbox"/> -N
													<input type="checkbox"/> -Y / <input type="checkbox"/> -N	<input type="checkbox"/> -Y / <input type="checkbox"/> -N
													<input type="checkbox"/> -Y / <input type="checkbox"/> -N	<input type="checkbox"/> -Y / <input type="checkbox"/> -N

PAGE 1 OF 1

Print Name & Initial: Anna Corrigan AC  
(field notes author)

Quality Control:

Print Name & Initial: Andrew Taylor A.T.  
(field notes QA/QC personnel)

This form is complete & legible



### Searcher Efficiency Record Form

Project No: 160961010      Project Name: Adelaide Wind Farm

Date: July 30, 2015      Field Personnel: Ken Edwards

TESTER: Sam Soehn

Weather Conditions: 16-17.5 / NE      15% None None  
 TEMP (°C)      WIND (speed / direction)      CLOUD      PPT      PPT (last 24-hrs)

% VEG. COVER	VEG. HEIGHT	VISIBILITY CLASS*
≥ 90% bare ground	≤ 15cm tall	Class 1 (Easy)
≥ 25% bare ground	≤ 15cm tall	Class 2 (Moderate)
≤ 25% bare ground	≤ 25% > 30cm tall	Class 3 (Difficult)
Little/no bare ground	≥ 25% > 30cm tall	Class 4 (Very difficult)

Turbine No.	Time Placed	Time Collected	Species	Marker Used	Condition frozen/thawed	UTM Coordinates			Position from turbine		Substrate	Visibility Class*	Detected?	Scavenged?
						Zone	Easting	Northing	Dist. (m)	Direction				
27	6:33	n/a	bird	scotch tape	thawed	17T	E0435969	N4765440	5	WNW	access road	1	<input checked="" type="checkbox"/> -Y/ <input type="checkbox"/> -N	<input type="checkbox"/> -Y/ <input checked="" type="checkbox"/> -N
<del>20</del>	<del>6:46</del>		<del>Cuckoo</del>	<del>scotch tape</del>	<del>thawed</del>	<del>17T</del>	<del>E0440246</del>	<del>N4765205</del>	<del>25</del>	<del>SW</del>	<del>dirt</del>	<del>1</del>	<input type="checkbox"/> -Y/ <input checked="" type="checkbox"/> -N	<input type="checkbox"/> -Y/ <input checked="" type="checkbox"/> -N
12	7:01	5:30PM	hoary bat	scotch tape	thawed	17T	E0447889	N4763372	18	NE	dirt/weeds	2	<input type="checkbox"/> -Y/ <input checked="" type="checkbox"/> -N	<input type="checkbox"/> -Y/ <input checked="" type="checkbox"/> -N
							E	N					<input type="checkbox"/> -Y/ <input type="checkbox"/> -N	<input type="checkbox"/> -Y/ <input type="checkbox"/> -N
→ Ground under turbine was worked on recently after placing carcass - could not find carcass							E	N					<input type="checkbox"/> -Y/ <input type="checkbox"/> -N	<input type="checkbox"/> -Y/ <input type="checkbox"/> -N
* not included in data							E	N					<input type="checkbox"/> -Y/ <input type="checkbox"/> -N	<input type="checkbox"/> -Y/ <input type="checkbox"/> -N
							E	N					<input type="checkbox"/> -Y/ <input type="checkbox"/> -N	<input type="checkbox"/> -Y/ <input type="checkbox"/> -N
							E	N					<input type="checkbox"/> -Y/ <input type="checkbox"/> -N	<input type="checkbox"/> -Y/ <input type="checkbox"/> -N
							E	N					<input type="checkbox"/> -Y/ <input type="checkbox"/> -N	<input type="checkbox"/> -Y/ <input type="checkbox"/> -N
							E	N					<input type="checkbox"/> -Y/ <input type="checkbox"/> -N	<input type="checkbox"/> -Y/ <input type="checkbox"/> -N
							E	N					<input type="checkbox"/> -Y/ <input type="checkbox"/> -N	<input type="checkbox"/> -Y/ <input type="checkbox"/> -N
							E	N					<input type="checkbox"/> -Y/ <input type="checkbox"/> -N	<input type="checkbox"/> -Y/ <input type="checkbox"/> -N
							E	N					<input type="checkbox"/> -Y/ <input type="checkbox"/> -N	<input type="checkbox"/> -Y/ <input type="checkbox"/> -N
							E	N					<input type="checkbox"/> -Y/ <input type="checkbox"/> -N	<input type="checkbox"/> -Y/ <input type="checkbox"/> -N
							E	N					<input type="checkbox"/> -Y/ <input type="checkbox"/> -N	<input type="checkbox"/> -Y/ <input type="checkbox"/> -N
							E	N					<input type="checkbox"/> -Y/ <input type="checkbox"/> -N	<input type="checkbox"/> -Y/ <input type="checkbox"/> -N
							E	N					<input type="checkbox"/> -Y/ <input type="checkbox"/> -N	<input type="checkbox"/> -Y/ <input type="checkbox"/> -N
							E	N					<input type="checkbox"/> -Y/ <input type="checkbox"/> -N	<input type="checkbox"/> -Y/ <input type="checkbox"/> -N
							E	N					<input type="checkbox"/> -Y/ <input type="checkbox"/> -N	<input type="checkbox"/> -Y/ <input type="checkbox"/> -N
							E	N					<input type="checkbox"/> -Y/ <input type="checkbox"/> -N	<input type="checkbox"/> -Y/ <input type="checkbox"/> -N
							E	N					<input type="checkbox"/> -Y/ <input type="checkbox"/> -N	<input type="checkbox"/> -Y/ <input type="checkbox"/> -N
							E	N					<input type="checkbox"/> -Y/ <input type="checkbox"/> -N	<input type="checkbox"/> -Y/ <input type="checkbox"/> -N

PAGE 1 OF 1  
 Print Name & Initial: Sam Soehn SS

(field notes author)

Quality Control:  
 Print Name & Initial: Andrew Taylor A.T.

This form is complete  & legible   
 (field notes QA/QC personnel)

### Searcher Efficiency Record Form

Project No: 160961010 Project Name: Adelaide Wind Farm

Date: Aug 7, 2015 Field Personnel: Ken Edwards

TESTER: Sam Soehn

Weather Conditions: 14 2-3, SW 40% None None  
 TEMP (°C) WIND (speed / direction) CLOUD PPT PPT (last 24-hrs)

% VEG. COVER	VEG. HEIGHT	VISIBILITY CLASS*
≥ 90% bare ground	≤ 15cm tall	Class 1 (Easy)
≥ 25% bare ground	≤ 15cm tall	Class 2 (Moderate)
≤ 25% bare ground	≤ 25% > 30cm tall	Class 3 (Difficult)
Little/no bare ground	≥ 25% > 30cm tall	Class 4 (Very difficult)

Turbine No.	Time Placed	Time Collected	Species	Marker Used	Condition frozen/thawed	UTM Coordinates			Position from turbine		Substrate	Visibility Class*	Detected?	Scavenged?
						Zone	Easting	Northing	Dist. (m)	Direction				
14	7:05	4:10PM	bird	scotch tape	thawed	17T	E0447199	N4764854	27	E	soy	2	<input type="checkbox"/> -Y/ <input checked="" type="checkbox"/> -N	<input type="checkbox"/> -Y/ <input checked="" type="checkbox"/> -N
19	7:15	n/a	eastern red bat	scotch tape	thawed	17T	E0442946	N4764954	13	SWS	dirt	1	<input checked="" type="checkbox"/> -Y/ <input type="checkbox"/> -N	<input type="checkbox"/> -Y/ <input checked="" type="checkbox"/> -N
20	7:25	n/a	bird	<del>scotch tape</del> white string	thawed	17T	E0440254	N4765252	22	N	dirt	1	<input checked="" type="checkbox"/> -Y/ <input type="checkbox"/> -N	<input type="checkbox"/> -Y/ <input checked="" type="checkbox"/> -N
						E	N						<input type="checkbox"/> -Y/ <input type="checkbox"/> -N	<input type="checkbox"/> -Y/ <input type="checkbox"/> -N
						E	N						<input type="checkbox"/> -Y/ <input type="checkbox"/> -N	<input type="checkbox"/> -Y/ <input type="checkbox"/> -N
						E	N						<input type="checkbox"/> -Y/ <input type="checkbox"/> -N	<input type="checkbox"/> -Y/ <input type="checkbox"/> -N
						E	N						<input type="checkbox"/> -Y/ <input type="checkbox"/> -N	<input type="checkbox"/> -Y/ <input type="checkbox"/> -N
						E	N						<input type="checkbox"/> -Y/ <input type="checkbox"/> -N	<input type="checkbox"/> -Y/ <input type="checkbox"/> -N
						E	N						<input type="checkbox"/> -Y/ <input type="checkbox"/> -N	<input type="checkbox"/> -Y/ <input type="checkbox"/> -N
						E	N						<input type="checkbox"/> -Y/ <input type="checkbox"/> -N	<input type="checkbox"/> -Y/ <input type="checkbox"/> -N
						E	N						<input type="checkbox"/> -Y/ <input type="checkbox"/> -N	<input type="checkbox"/> -Y/ <input type="checkbox"/> -N
						E	N						<input type="checkbox"/> -Y/ <input type="checkbox"/> -N	<input type="checkbox"/> -Y/ <input type="checkbox"/> -N
						E	N						<input type="checkbox"/> -Y/ <input type="checkbox"/> -N	<input type="checkbox"/> -Y/ <input type="checkbox"/> -N
						E	N						<input type="checkbox"/> -Y/ <input type="checkbox"/> -N	<input type="checkbox"/> -Y/ <input type="checkbox"/> -N
						E	N						<input type="checkbox"/> -Y/ <input type="checkbox"/> -N	<input type="checkbox"/> -Y/ <input type="checkbox"/> -N
						E	N						<input type="checkbox"/> -Y/ <input type="checkbox"/> -N	<input type="checkbox"/> -Y/ <input type="checkbox"/> -N
						E	N						<input type="checkbox"/> -Y/ <input type="checkbox"/> -N	<input type="checkbox"/> -Y/ <input type="checkbox"/> -N
						E	N						<input type="checkbox"/> -Y/ <input type="checkbox"/> -N	<input type="checkbox"/> -Y/ <input type="checkbox"/> -N
						E	N						<input type="checkbox"/> -Y/ <input type="checkbox"/> -N	<input type="checkbox"/> -Y/ <input type="checkbox"/> -N
						E	N						<input type="checkbox"/> -Y/ <input type="checkbox"/> -N	<input type="checkbox"/> -Y/ <input type="checkbox"/> -N
						E	N						<input type="checkbox"/> -Y/ <input type="checkbox"/> -N	<input type="checkbox"/> -Y/ <input type="checkbox"/> -N
						E	N						<input type="checkbox"/> -Y/ <input type="checkbox"/> -N	<input type="checkbox"/> -Y/ <input type="checkbox"/> -N

PAGE 1 OF 1  
 Print Name & Initial: Sam Soehn SS  
 (field notes author)

Quality Control: \_\_\_\_\_ This form is complete  & legible   
 Print Name & Initial: Andrew Tajo A.T  
 (field notes QA/QC personnel)

### Searcher Efficiency Record Form

Project No: 160961010 Project Name: Adelaide Wind Farm

Date: Aug 13, 2015 Field Personnel: Ken Edwards

TESTER: Sam Soehn

Weather Conditions: 11 3 / NE 25% None None  
TEMP (°C) WIND (speed / direction) CLOUD PPT PPT (last 24-hrs)

% VEG. COVER	VEG. HEIGHT	VISIBILITY CLASS*
≥ 90% bare ground	≤ 15cm tall	Class 1 (Easy)
≥ 25% bare ground	≤ 15cm tall	Class 2 (Moderate)
≤ 25% bare ground	≤ 25% > 30cm tall	Class 3 (Difficult)
Little/no bare ground	≥ 25% > 30cm tall	Class 4 (Very difficult)

Turbine No.	Time Placed	Time Collected	Species	Marker Used	Condition <small>frozen/thawed</small>	UTM Coordinates			Position from turbine		Substrate	Visibility Class*	Detected?	Scavenged?
						Zone	Easting	Northing	Dist. (m)	Direction				
6	7:06	4:28	bird	scotch tape	thawed	17T	E 0451986	N 4762637	27	NE	dirt / soy	2	<input type="checkbox"/> -Y / <input checked="" type="checkbox"/> -N	<input type="checkbox"/> -Y / <input checked="" type="checkbox"/> -N
11	7:18	n/a	hoary bat	scotch tape	thawed	17T	E 0449149	N 4763622	2	SE	access road	1	<input checked="" type="checkbox"/> -Y / <input type="checkbox"/> -N	<input type="checkbox"/> -Y / <input checked="" type="checkbox"/> -N
22	7:35	n/a	hoary bat	scotch tape	thawed	17T	E 0438322	N 4763222	16	NE	access road	1	<input checked="" type="checkbox"/> -Y / <input type="checkbox"/> -N	<input type="checkbox"/> -Y / <input checked="" type="checkbox"/> -N
							E	N					<input type="checkbox"/> -Y / <input type="checkbox"/> -N	<input type="checkbox"/> -Y / <input type="checkbox"/> -N
							E	N					<input type="checkbox"/> -Y / <input type="checkbox"/> -N	<input type="checkbox"/> -Y / <input type="checkbox"/> -N
							E	N					<input type="checkbox"/> -Y / <input type="checkbox"/> -N	<input type="checkbox"/> -Y / <input type="checkbox"/> -N
							E	N					<input type="checkbox"/> -Y / <input type="checkbox"/> -N	<input type="checkbox"/> -Y / <input type="checkbox"/> -N
							E	N					<input type="checkbox"/> -Y / <input type="checkbox"/> -N	<input type="checkbox"/> -Y / <input type="checkbox"/> -N
							E	N					<input type="checkbox"/> -Y / <input type="checkbox"/> -N	<input type="checkbox"/> -Y / <input type="checkbox"/> -N
							E	N					<input type="checkbox"/> -Y / <input type="checkbox"/> -N	<input type="checkbox"/> -Y / <input type="checkbox"/> -N
							E	N					<input type="checkbox"/> -Y / <input type="checkbox"/> -N	<input type="checkbox"/> -Y / <input type="checkbox"/> -N
							E	N					<input type="checkbox"/> -Y / <input type="checkbox"/> -N	<input type="checkbox"/> -Y / <input type="checkbox"/> -N
							E	N					<input type="checkbox"/> -Y / <input type="checkbox"/> -N	<input type="checkbox"/> -Y / <input type="checkbox"/> -N
							E	N					<input type="checkbox"/> -Y / <input type="checkbox"/> -N	<input type="checkbox"/> -Y / <input type="checkbox"/> -N
							E	N					<input type="checkbox"/> -Y / <input type="checkbox"/> -N	<input type="checkbox"/> -Y / <input type="checkbox"/> -N
							E	N					<input type="checkbox"/> -Y / <input type="checkbox"/> -N	<input type="checkbox"/> -Y / <input type="checkbox"/> -N
							E	N					<input type="checkbox"/> -Y / <input type="checkbox"/> -N	<input type="checkbox"/> -Y / <input type="checkbox"/> -N
							E	N					<input type="checkbox"/> -Y / <input type="checkbox"/> -N	<input type="checkbox"/> -Y / <input type="checkbox"/> -N
							E	N					<input type="checkbox"/> -Y / <input type="checkbox"/> -N	<input type="checkbox"/> -Y / <input type="checkbox"/> -N
							E	N					<input type="checkbox"/> -Y / <input type="checkbox"/> -N	<input type="checkbox"/> -Y / <input type="checkbox"/> -N
							E	N					<input type="checkbox"/> -Y / <input type="checkbox"/> -N	<input type="checkbox"/> -Y / <input type="checkbox"/> -N
							E	N					<input type="checkbox"/> -Y / <input type="checkbox"/> -N	<input type="checkbox"/> -Y / <input type="checkbox"/> -N
							E	N					<input type="checkbox"/> -Y / <input type="checkbox"/> -N	<input type="checkbox"/> -Y / <input type="checkbox"/> -N

PAGE 1 OF 1  
 Print Name & Initial: Sam Soehn SS  
(field notes author)

Quality Control: \_\_\_\_\_ This form is complete  & legible   
 Print Name & Initial: Andrew Taylor A.T.  
(field notes QA/QC personnel)

### Searcher Efficiency Record Form

Project No: 160961010 Project Name: Adelaide Wind Farm

Date: Aug 20, 2015 Field Personnel: Ken Edwards

TESTER: Sam Soehn

Weather Conditions: 20 TEMP (°C)    10 WIND (speed / direction)    ESE CLOUD    100% Rain PPT    Rain PPT (last 24-hrs)    on/off

% VEG. COVER	VEG. HEIGHT	VISIBILITY CLASS*
≥ 90% bare ground	≤ 15cm tall	Class 1 (Easy)
≥ 25% bare ground	≤ 15cm tall	Class 2 (Moderate)
≤ 25% bare ground	≤ 25% > 30cm tall	Class 3 (Difficult)
Little/no bare ground	≥ 25% > 30cm tall	Class 4 (Very difficult)

Turbine No.	Time Placed	Time Collected	Species	Marker Used	Condition frozen/thawed	UTM Coordinates			Position from turbine		Substrate	Visibility Class*	Detected?	Scavenged?
						Zone	Easting	Northing	Dist. (m)	Direction				
11	6:35	n/a	bird	scotch tape	thawed	17T	E0449169	N4763630	22	NE	soy	2	<input checked="" type="checkbox"/> -Y / <input type="checkbox"/> -N	<input type="checkbox"/> -Y / <input checked="" type="checkbox"/> -N
12	6:46	n/a	bird	scotch tape	thawed	17T	E0447862	N4763349	15	SW	access road	1	<input checked="" type="checkbox"/> -Y / <input type="checkbox"/> -N	<input type="checkbox"/> -Y / <input checked="" type="checkbox"/> -N
6	7:09	n/a	Big Brown Bat	scotch tape	thawed	17T	E0451970	N4762628	24	N	soy	2	<input checked="" type="checkbox"/> -Y / <input type="checkbox"/> -N	<input type="checkbox"/> -Y / <input checked="" type="checkbox"/> -N
							E	N					<input type="checkbox"/> -Y / <input type="checkbox"/> -N	<input type="checkbox"/> -Y / <input type="checkbox"/> -N
							E	N					<input type="checkbox"/> -Y / <input type="checkbox"/> -N	<input type="checkbox"/> -Y / <input type="checkbox"/> -N
							E	N					<input type="checkbox"/> -Y / <input type="checkbox"/> -N	<input type="checkbox"/> -Y / <input type="checkbox"/> -N
							E	N					<input type="checkbox"/> -Y / <input type="checkbox"/> -N	<input type="checkbox"/> -Y / <input type="checkbox"/> -N
							E	N					<input type="checkbox"/> -Y / <input type="checkbox"/> -N	<input type="checkbox"/> -Y / <input type="checkbox"/> -N
							E	N					<input type="checkbox"/> -Y / <input type="checkbox"/> -N	<input type="checkbox"/> -Y / <input type="checkbox"/> -N
							E	N					<input type="checkbox"/> -Y / <input type="checkbox"/> -N	<input type="checkbox"/> -Y / <input type="checkbox"/> -N
							E	N					<input type="checkbox"/> -Y / <input type="checkbox"/> -N	<input type="checkbox"/> -Y / <input type="checkbox"/> -N
							E	N					<input type="checkbox"/> -Y / <input type="checkbox"/> -N	<input type="checkbox"/> -Y / <input type="checkbox"/> -N
							E	N					<input type="checkbox"/> -Y / <input type="checkbox"/> -N	<input type="checkbox"/> -Y / <input type="checkbox"/> -N
							E	N					<input type="checkbox"/> -Y / <input type="checkbox"/> -N	<input type="checkbox"/> -Y / <input type="checkbox"/> -N
							E	N					<input type="checkbox"/> -Y / <input type="checkbox"/> -N	<input type="checkbox"/> -Y / <input type="checkbox"/> -N
							E	N					<input type="checkbox"/> -Y / <input type="checkbox"/> -N	<input type="checkbox"/> -Y / <input type="checkbox"/> -N
							E	N					<input type="checkbox"/> -Y / <input type="checkbox"/> -N	<input type="checkbox"/> -Y / <input type="checkbox"/> -N
							E	N					<input type="checkbox"/> -Y / <input type="checkbox"/> -N	<input type="checkbox"/> -Y / <input type="checkbox"/> -N
							E	N					<input type="checkbox"/> -Y / <input type="checkbox"/> -N	<input type="checkbox"/> -Y / <input type="checkbox"/> -N
							E	N					<input type="checkbox"/> -Y / <input type="checkbox"/> -N	<input type="checkbox"/> -Y / <input type="checkbox"/> -N
							E	N					<input type="checkbox"/> -Y / <input type="checkbox"/> -N	<input type="checkbox"/> -Y / <input type="checkbox"/> -N
							E	N					<input type="checkbox"/> -Y / <input type="checkbox"/> -N	<input type="checkbox"/> -Y / <input type="checkbox"/> -N

PAGE 1 OF 1  
 Print Name & Initial: Sam Soehn SS  
 (field notes author)

Quality Control: \_\_\_\_\_  
 Print Name & Initial: Andrew Taylor A.T.  
 (field notes QA/QC personnel)





**Searcher Efficiency  
Record Form**

T-6

T-11

T-14

Project No: 160961010 Project Name: Adelaide Wind Farm

Date: Aug 27 2015 Field Personnel: Ken Edwards

TESTER: Anna Corrigan

Weather: 13-14°C | 17km/h W | 95% | Drizzle | Rain  
Conditions: TEMP (°C) WIND CLOUD PPT PPT (last 24-hrs)

% VEG. COVER	VEG. HEIGHT	VISIBILITY CLASS*
≥ 90% bare ground	≤ 15cm tall	Class 1 (Easy)
≥ 25% bare ground	≤ 15cm tall	Class 2 (Moderate)
≤ 25% bare ground	≤ 25% > 30cm tall	Class 3 (Difficult)
Little/no bare ground	≥ 25% > 30cm tall	Class 4 (Very difficult)

Turbine No.	Time Placed	Time Collected	Species	Marker Used	Condition frozen/thawed	UTM Coordinates			Position from turbine		Substrate	Visibility Class*	Detected?	Scavenged?
						Zone	Easting	Northing	Dist. (m)	Direction				
6	6:55 am	n/a	Cliff Swallow	Clear Tape	Thawed	17	0451987	4762591	20	SE	dirt/weeds	2	<input checked="" type="checkbox"/> Y / <input type="checkbox"/> N	<input type="checkbox"/> Y / <input checked="" type="checkbox"/> N
													<input type="checkbox"/> Y / <input type="checkbox"/> N	<input type="checkbox"/> Y / <input type="checkbox"/> N
11	7:10 am	n/a	American Redstart	Orange Tape	Thawed	17	0449150	4763624	0.5	N	turbine base	1	<input checked="" type="checkbox"/> Y / <input type="checkbox"/> N	<input type="checkbox"/> Y / <input checked="" type="checkbox"/> N
													<input type="checkbox"/> Y / <input type="checkbox"/> N	<input type="checkbox"/> Y / <input type="checkbox"/> N
14	7:25 am	n/a	Hoary Bat	Clear Tape	Thawed	17	0447166	4764827	24	S	dirt/weeds	2	<input checked="" type="checkbox"/> Y / <input type="checkbox"/> N	<input type="checkbox"/> Y / <input checked="" type="checkbox"/> N
													<input type="checkbox"/> Y / <input type="checkbox"/> N	<input type="checkbox"/> Y / <input type="checkbox"/> N
													<input type="checkbox"/> Y / <input type="checkbox"/> N	<input type="checkbox"/> Y / <input type="checkbox"/> N
													<input type="checkbox"/> Y / <input type="checkbox"/> N	<input type="checkbox"/> Y / <input type="checkbox"/> N
													<input type="checkbox"/> Y / <input type="checkbox"/> N	<input type="checkbox"/> Y / <input type="checkbox"/> N
													<input type="checkbox"/> Y / <input type="checkbox"/> N	<input type="checkbox"/> Y / <input type="checkbox"/> N
													<input type="checkbox"/> Y / <input type="checkbox"/> N	<input type="checkbox"/> Y / <input type="checkbox"/> N
													<input type="checkbox"/> Y / <input type="checkbox"/> N	<input type="checkbox"/> Y / <input type="checkbox"/> N
													<input type="checkbox"/> Y / <input type="checkbox"/> N	<input type="checkbox"/> Y / <input type="checkbox"/> N
													<input type="checkbox"/> Y / <input type="checkbox"/> N	<input type="checkbox"/> Y / <input type="checkbox"/> N
													<input type="checkbox"/> Y / <input type="checkbox"/> N	<input type="checkbox"/> Y / <input type="checkbox"/> N
													<input type="checkbox"/> Y / <input type="checkbox"/> N	<input type="checkbox"/> Y / <input type="checkbox"/> N
													<input type="checkbox"/> Y / <input type="checkbox"/> N	<input type="checkbox"/> Y / <input type="checkbox"/> N

PAGE 1 OF 1  
Print Name & Initial: Anna Corrigan *AC*  
(field notes author)

Quality Control: \_\_\_\_\_ This form is complete  & legible   
Print Name & Initial: Andrew Taylor *A.T.*  
(field notes QA/QC personnel)



**Searcher Efficiency  
Record Form**

T-12

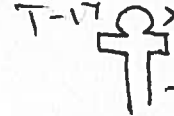

-was skip N of T

T-1a

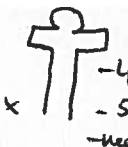

-42 steps  
-5 steps S  
-near orange

Project No: 160961010 Project Name: Adelaide Wind Farm

Date: September 3, 2015 Field Personnel: *A. Corrigan*

TESTER: *A. Corrigan* *Ken Edwards*

Weather: 21-22 2-6km/h NW 100 Fog/Direct Fog  
Conditions: TEMP (°C) WIND CLOUD PPT PPT (last 24-hrs)

% VEG. COVER	VEG. HEIGHT	VISIBILITY CLASS*
≥ 90% bare ground	≤ 15cm tall	Class 1 (Easy)
≥ 25% bare ground	≤ 15cm tall	Class 2 (Moderate)
≤ 25% bare ground	≤ 25% > 30cm tall	Class 3 (Difficult)
Little/no bare ground	≥ 25% > 30cm tall	Class 4 (Very difficult)

Turbine No.	Time Placed	Time Collected	Species	Marker Used	Condition frozen/thawed	UTM Coordinates			Position from turbine		Substrate	Visibility Class*	Detected?	Scavenged?
						Zone	Easting	Northing	Dist. (m)	Direction				
12	6:45am	15:00	AMRO	Clear Tape	Thawed	17	0447855	4763365	15	W	gravel	1	<input type="checkbox"/> -Y/ <input checked="" type="checkbox"/> -N	<input type="checkbox"/> -Y/ <input checked="" type="checkbox"/> -N
													<input type="checkbox"/> -Y/ <input type="checkbox"/> -N	<input type="checkbox"/> -Y/ <input type="checkbox"/> -N
17	7:05am	/	Hoary Bat	Orange Tape	Thawed	17	044503 50444503	4765073	10	N	dirt/weeds	2	<input checked="" type="checkbox"/> -Y/ <input type="checkbox"/> -N	<input type="checkbox"/> -Y/ <input checked="" type="checkbox"/> -N
													<input type="checkbox"/> -Y/ <input type="checkbox"/> -N	<input type="checkbox"/> -Y/ <input type="checkbox"/> -N
19	7:20am	/	Eastern Red Bat	Clear Tape	Thawed	17	0442985	4764956	42	E	dirt	1	<input checked="" type="checkbox"/> -Y/ <input type="checkbox"/> -N	<input type="checkbox"/> -Y/ <input checked="" type="checkbox"/> -N
													<input type="checkbox"/> -Y/ <input type="checkbox"/> -N	<input type="checkbox"/> -Y/ <input type="checkbox"/> -N
													<input type="checkbox"/> -Y/ <input type="checkbox"/> -N	<input type="checkbox"/> -Y/ <input type="checkbox"/> -N
													<input type="checkbox"/> -Y/ <input type="checkbox"/> -N	<input type="checkbox"/> -Y/ <input type="checkbox"/> -N
													<input type="checkbox"/> -Y/ <input type="checkbox"/> -N	<input type="checkbox"/> -Y/ <input type="checkbox"/> -N
													<input type="checkbox"/> -Y/ <input type="checkbox"/> -N	<input type="checkbox"/> -Y/ <input type="checkbox"/> -N
													<input type="checkbox"/> -Y/ <input type="checkbox"/> -N	<input type="checkbox"/> -Y/ <input type="checkbox"/> -N
													<input type="checkbox"/> -Y/ <input type="checkbox"/> -N	<input type="checkbox"/> -Y/ <input type="checkbox"/> -N
													<input type="checkbox"/> -Y/ <input type="checkbox"/> -N	<input type="checkbox"/> -Y/ <input type="checkbox"/> -N
													<input type="checkbox"/> -Y/ <input type="checkbox"/> -N	<input type="checkbox"/> -Y/ <input type="checkbox"/> -N
													<input type="checkbox"/> -Y/ <input type="checkbox"/> -N	<input type="checkbox"/> -Y/ <input type="checkbox"/> -N

PAGE 1 OF 1  
Print Name & Initial: *Amanda Corrigan AC*  
(field notes author)

Quality Control: This form is complete  & legible   
Print Name & Initial: *Amanda Bichel AB*  
(field notes QA/QC personnel)

### Searcher Efficiency Record Form

Project No: 160961010      Project Name: Adelaide Wind Farm

Date: Sept. 10, 2015      Field Personnel: Ken Edwards

TESTER: Sam Soehn

Weather Conditions: 10 / 1 / SE      25% None      Rain  
TEMP (°C)      WIND (speed / direction)      CLOUD      PPT      PPT (last 24-hrs)

% VEG. COVER	VEG. HEIGHT	VISIBILITY CLASS*
≥ 90% bare ground	≤ 15cm tall	Class 1 (Easy)
≥ 25% bare ground	≤ 15cm tall	Class 2 (Moderate)
≤ 25% bare ground	≤ 25% > 30cm tall	Class 3 (Difficult)
Little/no bare ground	≥ 25% > 30cm tall	Class 4 (Very difficult)

Turbine No.	Time Placed	Time Collected	Species	Marker Used	Condition <small>frozen/thawed</small>	UTM Coordinates			Position from turbine		Substrate	Visibility Class*	Detected?	Scavenged?
						Zone	Easting	Northing	Dist. (m)	Direction				
6	6:30	—	bird	Scotch tape	thawed	17T	E 0451980	N 4762595	16	E	Grass/ Dirt	2	<input type="checkbox"/> -Y / <input checked="" type="checkbox"/> -N	<input checked="" type="checkbox"/> -Y / <input type="checkbox"/> -N
11	6:41	Sept 14 12:00 PM	bat	Scotch tape	thawed	17T	E 0449151	N 4763624	2	NE	Access Road	1	<input type="checkbox"/> -Y / <input checked="" type="checkbox"/> -N	<input type="checkbox"/> -Y / <input checked="" type="checkbox"/> -N
14	6:50	—	bird	Scotch tape	thawed	17T	E 0447158	N 4764846	11	SW	Access Road	1	<input type="checkbox"/> -Y / <input checked="" type="checkbox"/> -N	<input checked="" type="checkbox"/> -Y / <input type="checkbox"/> -N
						E		N					<input type="checkbox"/> -Y / <input type="checkbox"/> -N	<input type="checkbox"/> -Y / <input type="checkbox"/> -N
						E		N					<input type="checkbox"/> -Y / <input type="checkbox"/> -N	<input type="checkbox"/> -Y / <input type="checkbox"/> -N
						E		N					<input type="checkbox"/> -Y / <input type="checkbox"/> -N	<input type="checkbox"/> -Y / <input type="checkbox"/> -N
						E		N					<input type="checkbox"/> -Y / <input type="checkbox"/> -N	<input type="checkbox"/> -Y / <input type="checkbox"/> -N
						E		N					<input type="checkbox"/> -Y / <input type="checkbox"/> -N	<input type="checkbox"/> -Y / <input type="checkbox"/> -N
						E		N					<input type="checkbox"/> -Y / <input type="checkbox"/> -N	<input type="checkbox"/> -Y / <input type="checkbox"/> -N
						E		N					<input type="checkbox"/> -Y / <input type="checkbox"/> -N	<input type="checkbox"/> -Y / <input type="checkbox"/> -N
						E		N					<input type="checkbox"/> -Y / <input type="checkbox"/> -N	<input type="checkbox"/> -Y / <input type="checkbox"/> -N
						E		N					<input type="checkbox"/> -Y / <input type="checkbox"/> -N	<input type="checkbox"/> -Y / <input type="checkbox"/> -N
						E		N					<input type="checkbox"/> -Y / <input type="checkbox"/> -N	<input type="checkbox"/> -Y / <input type="checkbox"/> -N
						E		N					<input type="checkbox"/> -Y / <input type="checkbox"/> -N	<input type="checkbox"/> -Y / <input type="checkbox"/> -N
						E		N					<input type="checkbox"/> -Y / <input type="checkbox"/> -N	<input type="checkbox"/> -Y / <input type="checkbox"/> -N
						E		N					<input type="checkbox"/> -Y / <input type="checkbox"/> -N	<input type="checkbox"/> -Y / <input type="checkbox"/> -N
						E		N					<input type="checkbox"/> -Y / <input type="checkbox"/> -N	<input type="checkbox"/> -Y / <input type="checkbox"/> -N
						E		N					<input type="checkbox"/> -Y / <input type="checkbox"/> -N	<input type="checkbox"/> -Y / <input type="checkbox"/> -N
						E		N					<input type="checkbox"/> -Y / <input type="checkbox"/> -N	<input type="checkbox"/> -Y / <input type="checkbox"/> -N
						E		N					<input type="checkbox"/> -Y / <input type="checkbox"/> -N	<input type="checkbox"/> -Y / <input type="checkbox"/> -N
						E		N					<input type="checkbox"/> -Y / <input type="checkbox"/> -N	<input type="checkbox"/> -Y / <input type="checkbox"/> -N
						E		N					<input type="checkbox"/> -Y / <input type="checkbox"/> -N	<input type="checkbox"/> -Y / <input type="checkbox"/> -N
						E		N					<input type="checkbox"/> -Y / <input type="checkbox"/> -N	<input type="checkbox"/> -Y / <input type="checkbox"/> -N
						E		N					<input type="checkbox"/> -Y / <input type="checkbox"/> -N	<input type="checkbox"/> -Y / <input type="checkbox"/> -N
						E		N					<input type="checkbox"/> -Y / <input type="checkbox"/> -N	<input type="checkbox"/> -Y / <input type="checkbox"/> -N
						E		N					<input type="checkbox"/> -Y / <input type="checkbox"/> -N	<input type="checkbox"/> -Y / <input type="checkbox"/> -N
						E		N					<input type="checkbox"/> -Y / <input type="checkbox"/> -N	<input type="checkbox"/> -Y / <input type="checkbox"/> -N
						E		N					<input type="checkbox"/> -Y / <input type="checkbox"/> -N	<input type="checkbox"/> -Y / <input type="checkbox"/> -N
						E		N					<input type="checkbox"/> -Y / <input type="checkbox"/> -N	<input type="checkbox"/> -Y / <input type="checkbox"/> -N
						E		N					<input type="checkbox"/> -Y / <input type="checkbox"/> -N	<input type="checkbox"/> -Y / <input type="checkbox"/> -N
						E		N					<input type="checkbox"/> -Y / <input type="checkbox"/> -N	<input type="checkbox"/> -Y / <input type="checkbox"/> -N
						E		N					<input type="checkbox"/> -Y / <input type="checkbox"/> -N	<input type="checkbox"/> -Y / <input type="checkbox"/> -N
						E		N					<input type="checkbox"/> -Y / <input type="checkbox"/> -N	<input type="checkbox"/> -Y / <input type="checkbox"/> -N
						E		N					<input type="checkbox"/> -Y / <input type="checkbox"/> -N	<input type="checkbox"/> -Y / <input type="checkbox"/> -N
						E		N					<input type="checkbox"/> -Y / <input type="checkbox"/> -N	<input type="checkbox"/> -Y / <input type="checkbox"/> -N
						E		N					<input type="checkbox"/> -Y / <input type="checkbox"/> -N	<input type="checkbox"/> -Y / <input type="checkbox"/> -N
						E		N					<input type="checkbox"/> -Y / <input type="checkbox"/> -N	<input type="checkbox"/> -Y / <input type="checkbox"/> -N

PAGE 1 OF 1  
 Print Name & Initial: Sam Soehn SS  
(field notes author)

Quality Control: \_\_\_\_\_ This form is complete  & legible   
 Print Name & Initial: Amanda Richel AB  
(field notes QA/QC personnel)



**Searcher Efficiency  
Record Form**

Project No: 160961010 Project Name: Adelaide Wind Farm  
Date: Sept 14, 2015 Field Personnel: Ken Edwards  
TESTER: Anna Corrigan  
Weather: 9-10°C | 5-8 km/h W | 20% | None | None  
Conditions: TEMP (°C) WIND CLOUD PPT PPT (last 24-hrs)

T-27



→ beside a full piece of dead veg.

T-22



→ beside green box, next to pavement

T-12



→ side of access road

% VEG. COVER	VEG. HEIGHT	VISIBILITY CLASS*
≥ 90% bare ground	≤ 15cm tall	Class 1 (Easy)
≥ 25% bare ground	≤ 15cm tall	Class 2 (Moderate)
≤ 25% bare ground	≤ 25% > 30cm tall	Class 3 (Difficult)
Little/no bare ground	≥ 25% > 30cm tall	Class 4 (Very difficult)

Turbine No.	Time Placed	Time Collected	Species	Marker Used	Condition frozen/thawed	UTM Coordinates			Position from turbine		Substrate	Visibility Class*	Detected?	Scavenged?
						Zone	Easting	Northing	Dist. (m)	Direction				
27	7:15 am	n/a	AMRD	Orange Tape	Thawed	17	0435989	4765457	23	SE	dirt	1	<input checked="" type="checkbox"/> -Y/ <input type="checkbox"/> -N	<input type="checkbox"/> -Y/ <input checked="" type="checkbox"/> -N
													<input type="checkbox"/> -Y/ <input type="checkbox"/> -N	<input type="checkbox"/> -Y/ <input type="checkbox"/> -N
22	7:25 am	n/a	LACI	Pink Tape	Thawed	17	0438310	4763206	5	W	gravel	1	<input checked="" type="checkbox"/> -Y/ <input type="checkbox"/> -N	<input type="checkbox"/> -Y/ <input checked="" type="checkbox"/> -N
													<input type="checkbox"/> -Y/ <input type="checkbox"/> -N	<input type="checkbox"/> -Y/ <input type="checkbox"/> -N
12	7:45 am	16:00	WTSP	White Label	Thawed	17	0447835	4763358	46	W	gravel	1	<input type="checkbox"/> -Y/ <input checked="" type="checkbox"/> -N	<input type="checkbox"/> -Y/ <input checked="" type="checkbox"/> -N
													<input type="checkbox"/> -Y/ <input type="checkbox"/> -N	<input type="checkbox"/> -Y/ <input type="checkbox"/> -N
													<input type="checkbox"/> -Y/ <input type="checkbox"/> -N	<input type="checkbox"/> -Y/ <input type="checkbox"/> -N
													<input type="checkbox"/> -Y/ <input type="checkbox"/> -N	<input type="checkbox"/> -Y/ <input type="checkbox"/> -N
													<input type="checkbox"/> -Y/ <input type="checkbox"/> -N	<input type="checkbox"/> -Y/ <input type="checkbox"/> -N
													<input type="checkbox"/> -Y/ <input type="checkbox"/> -N	<input type="checkbox"/> -Y/ <input type="checkbox"/> -N
													<input type="checkbox"/> -Y/ <input type="checkbox"/> -N	<input type="checkbox"/> -Y/ <input type="checkbox"/> -N
													<input type="checkbox"/> -Y/ <input type="checkbox"/> -N	<input type="checkbox"/> -Y/ <input type="checkbox"/> -N
													<input type="checkbox"/> -Y/ <input type="checkbox"/> -N	<input type="checkbox"/> -Y/ <input type="checkbox"/> -N
													<input type="checkbox"/> -Y/ <input type="checkbox"/> -N	<input type="checkbox"/> -Y/ <input type="checkbox"/> -N
													<input type="checkbox"/> -Y/ <input type="checkbox"/> -N	<input type="checkbox"/> -Y/ <input type="checkbox"/> -N
													<input type="checkbox"/> -Y/ <input type="checkbox"/> -N	<input type="checkbox"/> -Y/ <input type="checkbox"/> -N
													<input type="checkbox"/> -Y/ <input type="checkbox"/> -N	<input type="checkbox"/> -Y/ <input type="checkbox"/> -N

PAGE 1 OF 1  
Print Name & Initial: Anna Corrigan *AC*  
(field notes author)

Quality Control: \_\_\_\_\_ This form is complete  & legible   
Print Name & Initial: Amanda Bichel *AB*  
(field notes QA/QC personnel)

### Searcher Efficiency Record Form

Project No: 160961010      Project Name: Adelaide Wind Farm

Date: Sept. 17th, 2015      Field Personnel: Ken Edwards

TESTER: Sam Soehn

Weather Conditions: 14 TEMP (°C)      1 WIND (speed / direction) SW  
100% CLOUD      None PPT      None PPT (last 24-hrs)  
(fog)

% VEG. COVER	VEG. HEIGHT	VISIBILITY CLASS*
≥ 90% bare ground	≤ 15cm tall	Class 1 (Easy)
≥ 25% bare ground	≤ 15cm tall	Class 2 (Moderate)
≤ 25% bare ground	≤ 25% > 30cm tall	Class 3 (Difficult)
Little/no bare ground	≥ 25% > 30cm tall	Class 4 (Very difficult)

Turbine No.	Time Placed	Time Collected	Species	Marker Used	Condition frozen/thawed	UTM Coordinates			Position from turbine		Substrate	Visibility Class*	Detected?	Scavenged?
						Zone	Easting	Northing	Dist. (m)	Direction				
6	6:31	/	bird	scotch tape	thawed	17T	E0451996	N4762617	17	NE	weeds/ dirt	2	<input checked="" type="checkbox"/> -Y/ <input type="checkbox"/> -N	<input type="checkbox"/> -Y/ <input checked="" type="checkbox"/> -N
7	6:44	4:00PM	hoary bat	scotch tape	thawed	17T	E0449659	N4762149	5	NE	access road	4	<input type="checkbox"/> -Y/ <input checked="" type="checkbox"/> -N	<input type="checkbox"/> -Y/ <input checked="" type="checkbox"/> -N
14	6:59	/	hoary bat	scotch tape	thawed	17T	E0447189	N4764854	2	E	soy/ dirt	2	<input checked="" type="checkbox"/> -Y/ <input type="checkbox"/> -N	<input type="checkbox"/> -Y/ <input checked="" type="checkbox"/> -N
						E	N						<input type="checkbox"/> -Y/ <input type="checkbox"/> -N	<input type="checkbox"/> -Y/ <input type="checkbox"/> -N
						E	N						<input type="checkbox"/> -Y/ <input type="checkbox"/> -N	<input type="checkbox"/> -Y/ <input type="checkbox"/> -N
						E	N						<input type="checkbox"/> -Y/ <input type="checkbox"/> -N	<input type="checkbox"/> -Y/ <input type="checkbox"/> -N
						E	N						<input type="checkbox"/> -Y/ <input type="checkbox"/> -N	<input type="checkbox"/> -Y/ <input type="checkbox"/> -N
						E	N						<input type="checkbox"/> -Y/ <input type="checkbox"/> -N	<input type="checkbox"/> -Y/ <input type="checkbox"/> -N
						E	N						<input type="checkbox"/> -Y/ <input type="checkbox"/> -N	<input type="checkbox"/> -Y/ <input type="checkbox"/> -N
						E	N						<input type="checkbox"/> -Y/ <input type="checkbox"/> -N	<input type="checkbox"/> -Y/ <input type="checkbox"/> -N
						E	N						<input type="checkbox"/> -Y/ <input type="checkbox"/> -N	<input type="checkbox"/> -Y/ <input type="checkbox"/> -N
						E	N						<input type="checkbox"/> -Y/ <input type="checkbox"/> -N	<input type="checkbox"/> -Y/ <input type="checkbox"/> -N
						E	N						<input type="checkbox"/> -Y/ <input type="checkbox"/> -N	<input type="checkbox"/> -Y/ <input type="checkbox"/> -N
						E	N						<input type="checkbox"/> -Y/ <input type="checkbox"/> -N	<input type="checkbox"/> -Y/ <input type="checkbox"/> -N
						E	N						<input type="checkbox"/> -Y/ <input type="checkbox"/> -N	<input type="checkbox"/> -Y/ <input type="checkbox"/> -N
						E	N						<input type="checkbox"/> -Y/ <input type="checkbox"/> -N	<input type="checkbox"/> -Y/ <input type="checkbox"/> -N
						E	N						<input type="checkbox"/> -Y/ <input type="checkbox"/> -N	<input type="checkbox"/> -Y/ <input type="checkbox"/> -N
						E	N						<input type="checkbox"/> -Y/ <input type="checkbox"/> -N	<input type="checkbox"/> -Y/ <input type="checkbox"/> -N
						E	N						<input type="checkbox"/> -Y/ <input type="checkbox"/> -N	<input type="checkbox"/> -Y/ <input type="checkbox"/> -N
						E	N						<input type="checkbox"/> -Y/ <input type="checkbox"/> -N	<input type="checkbox"/> -Y/ <input type="checkbox"/> -N
						E	N						<input type="checkbox"/> -Y/ <input type="checkbox"/> -N	<input type="checkbox"/> -Y/ <input type="checkbox"/> -N
						E	N						<input type="checkbox"/> -Y/ <input type="checkbox"/> -N	<input type="checkbox"/> -Y/ <input type="checkbox"/> -N
						E	N						<input type="checkbox"/> -Y/ <input type="checkbox"/> -N	<input type="checkbox"/> -Y/ <input type="checkbox"/> -N

PAGE 1 OF 1  
 Print Name & Initial: Sam Soehn SS  
 (field notes author)

Quality Control: \_\_\_\_\_ This form is complete  & legible   
 Print Name & Initial: Amanda Bichel AB  
 (field notes QA/QC personnel)

**Searcher Efficiency Record Form**

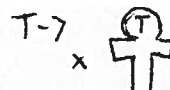

-> 10 steps North of pink flag

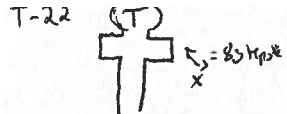

-> beside yellow flower

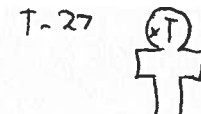

-> beside yellow pile

Project No: 160961067 Project Name: Adelaide Wind Farm  
 Date: Sept 21, 2015 Field Personnel: Anna Corrigan  
 TESTER: A. Corrigan Ken Edwards

Weather Conditions: 7°C-10°C 13-15 / E 60% ☉ ☉  
 TEMP (°C) km/h WIND CLOUD PPT PPT (last 24-hrs)  
 (speed / direction)

% VEG. COVER	VEG. HEIGHT	VISIBILITY CLASS*
≥ 90% bare ground	≤ 15cm tall	Class 1 (Easy)
≥ 25% bare ground	≤ 15cm tall	Class 2 (Moderate)
≤ 25% bare ground	≤ 25% > 30cm tall	Class 3 (Difficult)
Little/no bare ground	≥ 25% > 30cm tall	Class 4 (Very difficult)

Turbine No.	Time Placed	Time Collected	Species	Marker Used	Condition frozen/thawed	UTM Coordinates			Position from turbine		Substrate	Visibility Class*	Detected?	Scavenged?
						Zone	Easting	Northing	Dist. (m)	Direction				
7	7:10am	16:30	WTSP	White label	Thawed	17E	0449643	N4762168	30	NW	dirt	1	<input type="checkbox"/> -Y / <input checked="" type="checkbox"/> -N	<input type="checkbox"/> -Y / <input checked="" type="checkbox"/> -N
22	7:35am	16:15	LAC1	Clear Tape	Thawed	17E	0438331	N4763225	29	NE	dirt/weeds	2	<input type="checkbox"/> -Y / <input checked="" type="checkbox"/> -N	<input type="checkbox"/> -Y / <input checked="" type="checkbox"/> -N
27	7:45am	n/a	LAC1	Clear Tape	Thawed	17E	0435962	N4765464	3	S	gravel	1	<input checked="" type="checkbox"/> -Y / <input type="checkbox"/> -N	<input type="checkbox"/> -Y / <input checked="" type="checkbox"/> -N
						E		N					<input type="checkbox"/> -Y / <input type="checkbox"/> -N	<input type="checkbox"/> -Y / <input type="checkbox"/> -N
						E		N					<input type="checkbox"/> -Y / <input type="checkbox"/> -N	<input type="checkbox"/> -Y / <input type="checkbox"/> -N
						E		N					<input type="checkbox"/> -Y / <input type="checkbox"/> -N	<input type="checkbox"/> -Y / <input type="checkbox"/> -N
						E		N					<input type="checkbox"/> -Y / <input type="checkbox"/> -N	<input type="checkbox"/> -Y / <input type="checkbox"/> -N
						E		N					<input type="checkbox"/> -Y / <input type="checkbox"/> -N	<input type="checkbox"/> -Y / <input type="checkbox"/> -N
						E		N					<input type="checkbox"/> -Y / <input type="checkbox"/> -N	<input type="checkbox"/> -Y / <input type="checkbox"/> -N
						E		N					<input type="checkbox"/> -Y / <input type="checkbox"/> -N	<input type="checkbox"/> -Y / <input type="checkbox"/> -N
						E		N					<input type="checkbox"/> -Y / <input type="checkbox"/> -N	<input type="checkbox"/> -Y / <input type="checkbox"/> -N
						E		N					<input type="checkbox"/> -Y / <input type="checkbox"/> -N	<input type="checkbox"/> -Y / <input type="checkbox"/> -N
						E		N					<input type="checkbox"/> -Y / <input type="checkbox"/> -N	<input type="checkbox"/> -Y / <input type="checkbox"/> -N
						E		N					<input type="checkbox"/> -Y / <input type="checkbox"/> -N	<input type="checkbox"/> -Y / <input type="checkbox"/> -N
						E		N					<input type="checkbox"/> -Y / <input type="checkbox"/> -N	<input type="checkbox"/> -Y / <input type="checkbox"/> -N
						E		N					<input type="checkbox"/> -Y / <input type="checkbox"/> -N	<input type="checkbox"/> -Y / <input type="checkbox"/> -N
						E		N					<input type="checkbox"/> -Y / <input type="checkbox"/> -N	<input type="checkbox"/> -Y / <input type="checkbox"/> -N
						E		N					<input type="checkbox"/> -Y / <input type="checkbox"/> -N	<input type="checkbox"/> -Y / <input type="checkbox"/> -N
						E		N					<input type="checkbox"/> -Y / <input type="checkbox"/> -N	<input type="checkbox"/> -Y / <input type="checkbox"/> -N
						E		N					<input type="checkbox"/> -Y / <input type="checkbox"/> -N	<input type="checkbox"/> -Y / <input type="checkbox"/> -N
						E		N					<input type="checkbox"/> -Y / <input type="checkbox"/> -N	<input type="checkbox"/> -Y / <input type="checkbox"/> -N

PAGE 1 OF 1  
 Print Name & Initial: Anna Corrigan AC  
 (field notes author)

Quality Control: This form is complete  & legible   
 Print Name & Initial: Amanda Richel AR  
 (field notes QA/QC personnel)

### Searcher Efficiency Record Form

Project No: 160961010 Project Name: Adelaide Wind Farm

Date: Sept 28, 2015 Field Personnel: Ken Edwards

TESTER: Sam Soehn

Weather Conditions: 19 15 / NNE 100% None Rain  
TEMP (°C) WIND (speed / direction) CLOUD PPT PPT (last 24-hrs)

% VEG. COVER	VEG. HEIGHT	VISIBILITY CLASS*
≥ 90% bare ground	≤ 15cm tall	Class 1 (Easy)
≥ 25% bare ground	≤ 15cm tall	Class 2 (Moderate)
≤ 25% bare ground	≤ 25% > 30cm tall	Class 3 (Difficult)
Little/no bare ground	≥ 25% > 30cm tall	Class 4 (Very difficult)

Turbine No.	Time Placed	Time Collected	Species	Marker Used	Condition frozen/thawed	UTM Coordinates			Position from turbine		Substrate	Visibility Class*	Detected?	Scavenged?
						Zone	Easting	Northing	Dist. (m)	Direction				
17	8:00	n/a	eastern red bat	orange tape	thawed	17T	E0444513	N4765070	5	NE	access road	1	<input checked="" type="checkbox"/> -Y / <input type="checkbox"/> -N	<input type="checkbox"/> -Y / <input checked="" type="checkbox"/> -N
19	8:10	n/a	bird	white sticky scotch tape	thawed	17T	E0442936	N4764972	16	NW	dirt	1	<input checked="" type="checkbox"/> -Y / <input type="checkbox"/> -N	<input type="checkbox"/> -Y / <input checked="" type="checkbox"/> -N
22	8:22	n/a	grouse	scotch tape	thawed	17T	E0438316	N4763188	21	SE	weeds	2	<input checked="" type="checkbox"/> -Y / <input type="checkbox"/> -N	<input type="checkbox"/> -Y / <input checked="" type="checkbox"/> -N
						E		N					<input type="checkbox"/> -Y / <input type="checkbox"/> -N	<input type="checkbox"/> -Y / <input type="checkbox"/> -N
						E		N					<input type="checkbox"/> -Y / <input type="checkbox"/> -N	<input type="checkbox"/> -Y / <input type="checkbox"/> -N
						E		N					<input type="checkbox"/> -Y / <input type="checkbox"/> -N	<input type="checkbox"/> -Y / <input type="checkbox"/> -N
						E		N					<input type="checkbox"/> -Y / <input type="checkbox"/> -N	<input type="checkbox"/> -Y / <input type="checkbox"/> -N
						E		N					<input type="checkbox"/> -Y / <input type="checkbox"/> -N	<input type="checkbox"/> -Y / <input type="checkbox"/> -N
						E		N					<input type="checkbox"/> -Y / <input type="checkbox"/> -N	<input type="checkbox"/> -Y / <input type="checkbox"/> -N
						E		N					<input type="checkbox"/> -Y / <input type="checkbox"/> -N	<input type="checkbox"/> -Y / <input type="checkbox"/> -N
						E		N					<input type="checkbox"/> -Y / <input type="checkbox"/> -N	<input type="checkbox"/> -Y / <input type="checkbox"/> -N
						E		N					<input type="checkbox"/> -Y / <input type="checkbox"/> -N	<input type="checkbox"/> -Y / <input type="checkbox"/> -N
						E		N					<input type="checkbox"/> -Y / <input type="checkbox"/> -N	<input type="checkbox"/> -Y / <input type="checkbox"/> -N
						E		N					<input type="checkbox"/> -Y / <input type="checkbox"/> -N	<input type="checkbox"/> -Y / <input type="checkbox"/> -N
						E		N					<input type="checkbox"/> -Y / <input type="checkbox"/> -N	<input type="checkbox"/> -Y / <input type="checkbox"/> -N
						E		N					<input type="checkbox"/> -Y / <input type="checkbox"/> -N	<input type="checkbox"/> -Y / <input type="checkbox"/> -N
						E		N					<input type="checkbox"/> -Y / <input type="checkbox"/> -N	<input type="checkbox"/> -Y / <input type="checkbox"/> -N
						E		N					<input type="checkbox"/> -Y / <input type="checkbox"/> -N	<input type="checkbox"/> -Y / <input type="checkbox"/> -N
						E		N					<input type="checkbox"/> -Y / <input type="checkbox"/> -N	<input type="checkbox"/> -Y / <input type="checkbox"/> -N
						E		N					<input type="checkbox"/> -Y / <input type="checkbox"/> -N	<input type="checkbox"/> -Y / <input type="checkbox"/> -N
						E		N					<input type="checkbox"/> -Y / <input type="checkbox"/> -N	<input type="checkbox"/> -Y / <input type="checkbox"/> -N
						E		N					<input type="checkbox"/> -Y / <input type="checkbox"/> -N	<input type="checkbox"/> -Y / <input type="checkbox"/> -N
						E		N					<input type="checkbox"/> -Y / <input type="checkbox"/> -N	<input type="checkbox"/> -Y / <input type="checkbox"/> -N

PAGE 1 OF 1  
 Print Name & Initial: Sam Soehn SS

(field notes author)

Quality Control: This form is complete  & legible   
 Print Name & Initial: Amanda Bichel AB

(field notes QA/QC personnel)



Stantec

Stantec Consulting Ltd.  
1 - 70 Southgate Drive,  
Guelph ON N1G 4P5

Searcher Efficiency  
Record Form

T-6

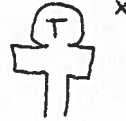

→ on a pile of cut soy  
→ 26 steps E of  
Must northern  
yellow pole

T-11



→ top left  
corner of  
access road  
→ 1 m away  
from gravel

T-14



→ 2 m N  
of access  
road  
gravel

Project No: 160961010 Project Name: Adelaide Wind Farm  
 Date: October 5, 2015 Field Personnel: Ken Edwards  
 TESTER: Anna Corrygan  
 Weather Conditions: 11°C TEMP (°C) | 1 WIND | 90% CLOUD | 0 PPT | Rain PPT (last 24-hrs)

% VEG. COVER	VEG. HEIGHT	VISIBILITY CLASS*
≥ 90% bare ground	≤ 15cm tall	Class 1 (Easy)
≥ 25% bare ground	≤ 15cm tall	Class 2 (Moderate)
≤ 25% bare ground	≤ 25% > 30cm tall	Class 3 (Difficult)
Little/no bare ground	≥ 25% > 30cm tall	Class 4 (Very difficult)

Turbine No.	Time Placed	Time Collected	Species	Marker Used	Condition frozen/thawed	UTM Coordinates			Position from turbine		Substrate	Visibility Class*	Detected?	Scavenged?
						Zone	Easting	Northing	Dist. (m)	Direction				
6	7:25a	n/a	Soil mite <sup>off</sup>	Orange Tape	Thawed	17	0451942	4762614	21	NNE	soy/dirt	1	<input checked="" type="checkbox"/> -Y/ <input type="checkbox"/> -N	<input type="checkbox"/> -Y/ <input checked="" type="checkbox"/> -N
11	7:45am	16:30	Honey bee	Orange Tape	Thawed	17	0449156	4763606	16	SSE	soy/dirt	2	<input type="checkbox"/> -Y/ <input checked="" type="checkbox"/> -N	<input type="checkbox"/> -Y/ <input checked="" type="checkbox"/> -N
14	8:00am	n/a	Killdeer	Orange Tape	Thawed	17	0447170	4764861	9	N	grass/weeds	2	<input checked="" type="checkbox"/> -Y/ <input type="checkbox"/> -N	<input type="checkbox"/> -Y/ <input checked="" type="checkbox"/> -N
													<input type="checkbox"/> -Y/ <input type="checkbox"/> -N	<input type="checkbox"/> -Y/ <input type="checkbox"/> -N
													<input type="checkbox"/> -Y/ <input type="checkbox"/> -N	<input type="checkbox"/> -Y/ <input type="checkbox"/> -N
													<input type="checkbox"/> -Y/ <input type="checkbox"/> -N	<input type="checkbox"/> -Y/ <input type="checkbox"/> -N
													<input type="checkbox"/> -Y/ <input type="checkbox"/> -N	<input type="checkbox"/> -Y/ <input type="checkbox"/> -N
													<input type="checkbox"/> -Y/ <input type="checkbox"/> -N	<input type="checkbox"/> -Y/ <input type="checkbox"/> -N
													<input type="checkbox"/> -Y/ <input type="checkbox"/> -N	<input type="checkbox"/> -Y/ <input type="checkbox"/> -N
													<input type="checkbox"/> -Y/ <input type="checkbox"/> -N	<input type="checkbox"/> -Y/ <input type="checkbox"/> -N
													<input type="checkbox"/> -Y/ <input type="checkbox"/> -N	<input type="checkbox"/> -Y/ <input type="checkbox"/> -N
													<input type="checkbox"/> -Y/ <input type="checkbox"/> -N	<input type="checkbox"/> -Y/ <input type="checkbox"/> -N
													<input type="checkbox"/> -Y/ <input type="checkbox"/> -N	<input type="checkbox"/> -Y/ <input type="checkbox"/> -N
													<input type="checkbox"/> -Y/ <input type="checkbox"/> -N	<input type="checkbox"/> -Y/ <input type="checkbox"/> -N
													<input type="checkbox"/> -Y/ <input type="checkbox"/> -N	<input type="checkbox"/> -Y/ <input type="checkbox"/> -N
													<input type="checkbox"/> -Y/ <input type="checkbox"/> -N	<input type="checkbox"/> -Y/ <input type="checkbox"/> -N
													<input type="checkbox"/> -Y/ <input type="checkbox"/> -N	<input type="checkbox"/> -Y/ <input type="checkbox"/> -N
													<input type="checkbox"/> -Y/ <input type="checkbox"/> -N	<input type="checkbox"/> -Y/ <input type="checkbox"/> -N
													<input type="checkbox"/> -Y/ <input type="checkbox"/> -N	<input type="checkbox"/> -Y/ <input type="checkbox"/> -N
													<input type="checkbox"/> -Y/ <input type="checkbox"/> -N	<input type="checkbox"/> -Y/ <input type="checkbox"/> -N
													<input type="checkbox"/> -Y/ <input type="checkbox"/> -N	<input type="checkbox"/> -Y/ <input type="checkbox"/> -N

PAGE 1 OF 1  
Print Name & Initial: Anna Corrygan *AC*  
(field notes author)

Quality Control: This form is complete  & legible   
Print Name & Initial: Amanda Bichel *AB*  
(field notes QA/QC personnel)



### Searcher Efficiency Record Form

Project No: 160961010 Project Name: Adelaide Wind Farm  
 Date: Oct 15, 2015 Field Personnel: Ken Edwards  
 TESTER: A. Corrigan

Weather Conditions: 7°C 8km/h SW 30% 0 drizzle  
 TEMP (°C) WIND (speed / direction) CLOUD PPT PPT (last 24-hrs)

% VEG. COVER	VEG. HEIGHT	VISIBILITY CLASS*
≥ 90% bare ground	≤ 15cm tall	Class 1 (Easy)
≥ 25% bare ground	≤ 15cm tall	Class 2 (Moderate)
≤ 25% bare ground	≤ 25% > 30cm tall	Class 3 (Difficult)
Little/no bare ground	≥ 25% > 30cm tall	Class 4 (Very difficult)

Turbine No.	Time Placed	Time Collected	Species	Marker Used	Condition frozen/thawed	UTM Coordinates			Position from turbine		Substrate	Visibility Class*	Detected?	Scavenged?		
						Zone	Easting	Northing	Dist. (m)	Direction						
12	7:45am	14:55	Heavy Bat	Orange Tape	Thawed	17	E 0447	N 4763	9	SSW	water/wheat	2	<input type="checkbox"/> -Y/ <input checked="" type="checkbox"/> -N	<input type="checkbox"/> -Y/ <input checked="" type="checkbox"/> -N		
							E 873	N 356							<input type="checkbox"/> -Y/ <input type="checkbox"/> -N	<input type="checkbox"/> -Y/ <input type="checkbox"/> -N
							E	N							<input type="checkbox"/> -Y/ <input type="checkbox"/> -N	<input type="checkbox"/> -Y/ <input type="checkbox"/> -N
22	8:15am	N/A	Red-tailed Hawk	Orange Tape	Thawed	17	E 0438	N 4763	29	NE	dirt/weeds	2	<input checked="" type="checkbox"/> -Y/ <input type="checkbox"/> -N	<input type="checkbox"/> -Y/ <input checked="" type="checkbox"/> -N		
							E 332	N 228							<input type="checkbox"/> -Y/ <input type="checkbox"/> -N	<input type="checkbox"/> -Y/ <input type="checkbox"/> -N
							E	N							<input type="checkbox"/> -Y/ <input type="checkbox"/> -N	<input type="checkbox"/> -Y/ <input type="checkbox"/> -N
27	8:30am	N/A	Tree Swallow	Orange Tape	Thawed	17	E 0435	N 4765	7	W	dirt/weeds	2	<input checked="" type="checkbox"/> -Y/ <input type="checkbox"/> -N	<input type="checkbox"/> -Y/ <input checked="" type="checkbox"/> -N		
							E 956	N 466							<input type="checkbox"/> -Y/ <input type="checkbox"/> -N	<input type="checkbox"/> -Y/ <input type="checkbox"/> -N
							E	N							<input type="checkbox"/> -Y/ <input type="checkbox"/> -N	<input type="checkbox"/> -Y/ <input type="checkbox"/> -N
							E	N							<input type="checkbox"/> -Y/ <input type="checkbox"/> -N	<input type="checkbox"/> -Y/ <input type="checkbox"/> -N
							E	N							<input type="checkbox"/> -Y/ <input type="checkbox"/> -N	<input type="checkbox"/> -Y/ <input type="checkbox"/> -N
							E	N							<input type="checkbox"/> -Y/ <input type="checkbox"/> -N	<input type="checkbox"/> -Y/ <input type="checkbox"/> -N
							E	N							<input type="checkbox"/> -Y/ <input type="checkbox"/> -N	<input type="checkbox"/> -Y/ <input type="checkbox"/> -N
							E	N							<input type="checkbox"/> -Y/ <input type="checkbox"/> -N	<input type="checkbox"/> -Y/ <input type="checkbox"/> -N
							E	N							<input type="checkbox"/> -Y/ <input type="checkbox"/> -N	<input type="checkbox"/> -Y/ <input type="checkbox"/> -N
							E	N							<input type="checkbox"/> -Y/ <input type="checkbox"/> -N	<input type="checkbox"/> -Y/ <input type="checkbox"/> -N

## Scavenger Trial Carcass Set-up & Daily Check Form

Project No: 160961010

Project Name: Adelaide Wind Farm

YEAR: 2015

 Personnel: Ken Edwards

 SEASON: Spring

 Weather: 18° 8km/h S

 30% No No  
 CLOUD PPT PPT (last 24 hrs)

on placement date TEMP (°C) WIND speed/direction

% VEG. COVER	VEG. HEIGHT	VISIBILITY CLASS*
≥ 90% bare ground	≤ 15cm tall	Class 1 (Easy)
≥ 25% bare ground	≤ 15cm tall	Class 2 (Moderate)
≤ 25% bare ground	≤ 25% > 30cm tall	Class 3 (Difficult)
Little/no bare ground	≥ 25% > 30cm tall	Class 4 (Very difficult)

Date Placed dd/mm	Turbine No.	Carcass No.	Species	Condition fresh/frozen	UTM Coordinates			Position from turbine		Visib. Class*	VISIT 1 1,2	VISIT 2 1,2	VISIT 3 1,2	VISIT 4 1,2
					Zone	Easting	Northing	Dist. (m)	Direction					
03/05	7	1	silver bat	Frozen	E 044	N 476	13	NE	1	Date: <u>May 4</u> Weather: <u>Mild</u> Scav'ged? <input type="checkbox"/> -Y / <input checked="" type="checkbox"/> -N	Date: <u>May 7</u> Weather: <u>warm</u> Scav'ged? <input type="checkbox"/> -Y / <input checked="" type="checkbox"/> -N	Date: <u>May 11</u> Weather: <u>cloudy</u> Scav'ged? <input checked="" type="checkbox"/> -Y / <input type="checkbox"/> -N	Date: <del>May 14</del> Weather: <del>cool</del> Scav'ged? <input type="checkbox"/> -Y / <input type="checkbox"/> -N	
03/05	12	2	small bird	Frozen	E 044	N 476	22	S	1	Date: <u>May 4</u> Weather: <u>Mild</u> Scav'ged? <input type="checkbox"/> -Y / <input checked="" type="checkbox"/> -N	Date: <u>May 7</u> Weather: <u>warm</u> Scav'ged? <input type="checkbox"/> -Y / <input checked="" type="checkbox"/> -N	Date: <u>May 11</u> Weather: <u>cloudy</u> Scav'ged? <input type="checkbox"/> -Y / <input checked="" type="checkbox"/> -N	Date: <u>May 14</u> Weather: <u>cool</u> Scav'ged? <input checked="" type="checkbox"/> -Y / <input type="checkbox"/> -N	
03/05	17	3	small bird	Frozen	E 044	N 476	7	W	1	Date: <u>May 4</u> Weather: <u>Mild</u> Scav'ged? <input type="checkbox"/> -Y / <input checked="" type="checkbox"/> -N	Date: <u>May 7</u> Weather: <u>warm</u> Scav'ged? <input checked="" type="checkbox"/> -Y / <input type="checkbox"/> -N	Date: <del>May 11</del> Weather: <del>cloudy</del> Scav'ged? <input type="checkbox"/> -Y / <input type="checkbox"/> -N	Date: <del>May 14</del> Weather: <del>cool</del> Scav'ged? <input type="checkbox"/> -Y / <input type="checkbox"/> -N	
03/05	20	4	hoary bat	Frozen	E 044	N 476	42	N/E	1	Date: <u>May 4</u> Weather: <u>Mild</u> Scav'ged? <input type="checkbox"/> -Y / <input checked="" type="checkbox"/> -N	Date: <u>May 7</u> Weather: <u>warm</u> Scav'ged? <input type="checkbox"/> -Y / <input checked="" type="checkbox"/> -N	Date: <u>May 11</u> Weather: <u>cloudy</u> Scav'ged? <input checked="" type="checkbox"/> -Y / <input type="checkbox"/> -N	Date: <del>May 14</del> Weather: <del>cool</del> Scav'ged? <input type="checkbox"/> -Y / <input type="checkbox"/> -N	
03/05	27	5	small bird	Frozen	E 043	N 476	19	SSE	1	Date: <u>May 4</u> Weather: <u>Mild</u> Scav'ged? <input type="checkbox"/> -Y / <input checked="" type="checkbox"/> -N	Date: <u>May 7</u> Weather: <u>warm</u> Scav'ged? <input checked="" type="checkbox"/> -Y / <input type="checkbox"/> -N	Date: <del>May 11</del> Weather: <del>cloudy</del> Scav'ged? <input type="checkbox"/> -Y / <input type="checkbox"/> -N	Date: <del>May 14</del> Weather: <del>cool</del> Scav'ged? <input type="checkbox"/> -Y / <input type="checkbox"/> -N	
					E	N				Date:	Date:	Date:	Date:	
					E	N				Weather:	Weather:	Weather:	Weather:	
					E	N				Scav'ged? <input type="checkbox"/> -Y / <input type="checkbox"/> -N	Scav'ged? <input type="checkbox"/> -Y / <input type="checkbox"/> -N	Scav'ged? <input type="checkbox"/> -Y / <input type="checkbox"/> -N	Scav'ged? <input type="checkbox"/> -Y / <input type="checkbox"/> -N	
					E	N				Date:	Date:	Date:	Date:	
					E	N				Weather:	Weather:	Weather:	Weather:	
					E	N				Scav'ged? <input type="checkbox"/> -Y / <input type="checkbox"/> -N	Scav'ged? <input type="checkbox"/> -Y / <input type="checkbox"/> -N	Scav'ged? <input type="checkbox"/> -Y / <input type="checkbox"/> -N	Scav'ged? <input type="checkbox"/> -Y / <input type="checkbox"/> -N	
					E	N				Date:	Date:	Date:	Date:	
					E	N				Weather:	Weather:	Weather:	Weather:	
					E	N				Scav'ged? <input type="checkbox"/> -Y / <input type="checkbox"/> -N	Scav'ged? <input type="checkbox"/> -Y / <input type="checkbox"/> -N	Scav'ged? <input type="checkbox"/> -Y / <input type="checkbox"/> -N	Scav'ged? <input type="checkbox"/> -Y / <input type="checkbox"/> -N	

\* See visibility class key at top of page

1 N-Not scavenged includes partial scavenging in which sufficient carcass remains for subsequent scavenging (e.g. only head removed, 1/2 or more of body remaining)

2 Y-Scavenged indicates that the carcass is entirely missing or parts remaining (e.g. feathers, wings, entrails) would not likely be further scavenged

PAGE 1 OF 4

 Print Name & Initial: Ken Edwards KE  
 (field notes author)

Quality Control:

 Print Name & Initial: Anna Corrigan AC  
 (field notes QA/QC personnel)

 This form is complete  & legible





## Scavenger Trial Carcass Set-up & Daily Check Form

\* Second half completed  
by Anna Corrigan

Project No: 160961010      Project Name: Adelaide Wind Farm  
 YEAR: 2015      Personnel: Ken Edwards  
 SEASON: Spring      Anna Corrigan  
 Weather: 20° S/6kmh SE      20%      00      00  
on placement date TEMP (°C)      WIND speed/direction      CLOUD      PPT      PPT (last 24 hrs)

% VEG. COVER	VEG. HEIGHT	VISIBILITY CLASS*
≥ 90% bare ground	≤ 15cm tall	Class 1 (Easy)
≥ 25% bare ground	≤ 15cm tall	Class 2 (Moderate)
≤ 25% bare ground	≤ 25% > 30cm tall	Class 3 (Difficult)
Little/no bare ground	≥ 25% > 30cm tall	Class 4 (Very difficult)

Date Placed dd/mm	Turbine No.	Carcass No.	Species	Condition fresh/frozen	UTM Coordinates			Position from turbine		Visib. Class*	VISIT 1 1,2	VISIT 2 1,2	VISIT 3 1,2	VISIT 4 1,2	
					Zone	Easting	Northing	Dist. (m)	Direction						
03/06/11	1	1	small bird	frozen	E 044	N 476	17T 9172	3607	25	SE	1	Date: June 4 Weather: warm Scav'ged? <input type="checkbox"/> -Y/ <input checked="" type="checkbox"/> -N	Date: June 8 Weather: Rain Scav'ged? <input type="checkbox"/> -Y/ <input checked="" type="checkbox"/> -N	Date: June 11 Weather: Sun/warm Scav'ged? <input type="checkbox"/> -Y/ <input checked="" type="checkbox"/> -N	Date: June 15 Weather: Cloudy/Hot Scav'ged? <input type="checkbox"/> -Y/ <input checked="" type="checkbox"/> -N
↳ next to glove, 10m left of access road															
03/06/12	2	2	hoary bat	frozen	E 044	N 476	17T 7877	3393	35	N	1	Date: June 4 Weather: warm Scav'ged? <input type="checkbox"/> -Y/ <input checked="" type="checkbox"/> -N	Date: June 8 Weather: Rain Scav'ged? <input type="checkbox"/> -Y/ <input checked="" type="checkbox"/> -N	Date: June 11 Weather: Sun/warm Scav'ged? <input type="checkbox"/> -Y/ <input checked="" type="checkbox"/> -N	Date: June 15 Weather: Sun/Hot Scav'ged? <input type="checkbox"/> -Y/ <input checked="" type="checkbox"/> -N
↳ next to gray piece of pipe, due north															
03/06/17	3	3	med. small bird	frozen	E 044	N 476	17T 4517	5037	30	SE	2	Date: June 4 Weather: warm Scav'ged? <input type="checkbox"/> -Y/ <input checked="" type="checkbox"/> -N	Date: June 8 Weather: Rain Scav'ged? <input type="checkbox"/> -Y/ <input checked="" type="checkbox"/> -N	Date: June 11 Weather: Sun/warm Scav'ged? <input type="checkbox"/> -Y/ <input checked="" type="checkbox"/> -N	Date: June 15 Weather: Cloudy/warm Scav'ged? <input type="checkbox"/> -Y/ <input checked="" type="checkbox"/> -N
↳ next to piece of black tile and white paper															
03/06/20	4	4	silver bat	fresh	E 044	N 476	0259	5240	10	N	1	Date: June 4 Weather: warm Scav'ged? <input type="checkbox"/> -Y/ <input checked="" type="checkbox"/> -N	Date: June 8 Weather: mild Scav'ged? <input type="checkbox"/> -Y/ <input checked="" type="checkbox"/> -N	Date: June 11 Weather: Cloudy/warm Scav'ged? <input type="checkbox"/> -Y/ <input checked="" type="checkbox"/> -N	Date: June 15 Weather: Cloudy/warm Scav'ged? <input type="checkbox"/> -Y/ <input checked="" type="checkbox"/> -N
↳ next to rock															
03/06/27	5	5	hoary bat	fresh	E 043	N 476	17T 5962	5461	3	S	1	Date: June 4 Weather: warm Scav'ged? <input type="checkbox"/> -Y/ <input checked="" type="checkbox"/> -N	Date: June 8 Weather: Rain Scav'ged? <input type="checkbox"/> -Y/ <input checked="" type="checkbox"/> -N	Date: June 11 Weather: Cloudy/warm Scav'ged? <input type="checkbox"/> -Y/ <input checked="" type="checkbox"/> -N	Date: June 15 Weather: Warm/Fog Scav'ged? <input type="checkbox"/> -Y/ <input checked="" type="checkbox"/> -N
↳ left of yellow roll on orange painted rock															

\* See visibility class key at top of page

<sup>1</sup> N-Not scavenged includes partial scavenging in which sufficient carcass remains for subsequent scavenging (e.g. only head removed, 1/2 or more of body remaining)

<sup>2</sup> Y-Scavenged indicates that the carcass is entirely missing or parts remaining (e.g. feathers, wings, entrails) would not likely be further scavenged

PAGE 3 OF 4

Print Name & Initial: Ken Edwards

(field notes author)

Quality Control:

Print Name & Initial: Amanda Bichel AB

(field notes QA/QC personnel)

This form is complete  & legible

FORM / REV: 2015-04-28

## Scavenger Trial Carcass Set-up & Daily Check Form

Project No: 160961010

Project Name: Adelaide Wind Farm

YEAR: 2015

 Personnel: Ken Edwards

 SEASON: Spring

 Weather: 18°C 26kph E

on placement date TEMP (°C)

WIND

CLOUD

PPT

PPT (last 24 hrs)

speed/direction

% VEG. COVER	VEG. HEIGHT	VISIBILITY CLASS*
≥ 90% bare ground	≤ 15cm tall	Class 1 (Easy)
≥ 25% bare ground	≤ 15cm tall	Class 2 (Moderate)
≤ 25% bare ground	≤ 25% > 30cm tall	Class 3 (Difficult)
Little/no bare ground	≥ 25% > 30cm tall	Class 4 (Very difficult)

Date Placed dd/mm	Turbine No.	Carcass No.	Species	Condition fresh/frozen	UTM Coordinates		Position from turbine		Visib. Class*	VISIT 1 1,2	VISIT 2 1,2	VISIT 3 1,2	VISIT 4 1,2	
					Zone	Easting	Northing	Dist. (m)						Direction
15/06	6	1	horned lark	frozen	17T	E 045 1977	N 476 2624	14	UNW	1	Date: June 18 Weather: overcast Scav'ged? <input type="checkbox"/> -Y / <input checked="" type="checkbox"/> -N	Date: June 22 Weather: warm Scav'ged? <input type="checkbox"/> -Y / <input checked="" type="checkbox"/> -N	Date: June 25 Weather: overcast Scav'ged? <input type="checkbox"/> -Y / <input checked="" type="checkbox"/> -N	Date: June 29 Weather: sunny Scav'ged? <input type="checkbox"/> -Y / <input checked="" type="checkbox"/> -N
						E	N				Date:	Date:	Date:	Date:
16/06	12	2	killdeer	frozen	17T	E 044 7870	N 476 3346	13	SSW	2	Date: June 18 Weather: overcast Scav'ged? <input type="checkbox"/> -Y / <input checked="" type="checkbox"/> -N	Date: June 22 Weather: warm Scav'ged? <input type="checkbox"/> -Y / <input checked="" type="checkbox"/> -N	Date: June 25 Weather: overcast Scav'ged? <input type="checkbox"/> -Y / <input checked="" type="checkbox"/> -N	Date: <del>June 29</del> Weather: <del>sunny</del> Scav'ged? <input type="checkbox"/> -Y / <input checked="" type="checkbox"/> -N
						E	N				Date:	Date:	Date:	Date:
17/06	14	3	big brown bat	frozen	17T	E 054 7162	N 476 4800	46	SSE	1	Date: June 18 Weather: overcast Scav'ged? <input checked="" type="checkbox"/> -Y / <input type="checkbox"/> -N	Date: <del>June 22</del> Weather: <del>warm</del> Scav'ged? <input type="checkbox"/> -Y / <input type="checkbox"/> -N	Date: <del>June 25</del> Weather: <del>overcast</del> Scav'ged? <input type="checkbox"/> -Y / <input type="checkbox"/> -N	Date: <del>June 29</del> Weather: <del>sunny</del> Scav'ged? <input type="checkbox"/> -Y / <input type="checkbox"/> -N
						E	N				Date:	Date:	Date:	Date:
17/06	19	4	small bird	frozen	17T	E 044 2960	N 476 4980	20	NE	1	Date: June 18 Weather: overcast Scav'ged? <input type="checkbox"/> -Y / <input checked="" type="checkbox"/> -N	Date: June 22 Weather: warm Scav'ged? <input type="checkbox"/> -Y / <input type="checkbox"/> -N	Date: <del>June 25</del> Weather: <del>overcast</del> Scav'ged? <input type="checkbox"/> -Y / <input type="checkbox"/> -N	Date: <del>June 29</del> Weather: <del>sunny</del> Scav'ged? <input type="checkbox"/> -Y / <input type="checkbox"/> -N
						E	N				Date:	Date:	Date:	Date:
17/06	22	5	big brown bat	frozen	17T	E 043 8308	N 476 3241	34	N	1	Date: June 18 Weather: overcast Scav'ged? <input type="checkbox"/> -Y / <input checked="" type="checkbox"/> -N	Date: June 22 Weather: warm Scav'ged? <input type="checkbox"/> -Y / <input checked="" type="checkbox"/> -N	Date: June 25 Weather: overcast Scav'ged? <input type="checkbox"/> -Y / <input checked="" type="checkbox"/> -N	Date: June 29 Weather: sunny Scav'ged? <input type="checkbox"/> -Y / <input checked="" type="checkbox"/> -N
			small red rock			E	N				Date:	Date:	Date:	Date:

\* See visibility class key at top of page

1 N-Not scavenged includes partial scavenging in which sufficient carcass remains for subsequent scavenging (e.g. only head removed, 1/2 or more of body remaining)

2 Y-Scavenged indicates that the carcass is entirely missing or parts remaining (e.g. feathers, wings, entrails) would not likely be further scavenged

PAGE 4 OF 4

 Print Name & Initial: Ken Edwards  
(field notes author)

Quality Control:

 This form is complete  & legible 

 Print Name & Initial: Anna Carigan  
(field notes QA/QC personnel)

## Scavenger Trial Carcass Set-up & Daily Check Form

Project No: 160961010      Project Name: Adelaide Wind Farm  
 YEAR: 2015      Personnel: Ken Edwards  
 SEASON: Summer  
 Weather: 20 0 km/h 1 SW  
 on placement date    TEMP (°C)    WIND    CLOUD    PPT    PPT (last 24 hrs)  
speed/direction

% VEG. COVER	VEG. HEIGHT	VISIBILITY CLASS*
≥ 90% bare ground	≤ 15cm tall	Class 1 (Easy)
≥ 25% bare ground	≤ 15cm tall	Class 2 (Moderate)
≤ 25% bare ground	≤ 25% > 30cm tall	Class 3 (Difficult)
Little/no bare ground	≥ 25% > 30cm tall	Class 4 (Very difficult)

Date Placed dd/mm	Turbine No.	Carcass No.	Species	Condition fresh/frozen	UTM Coordinates			Position from turbine		Visib. Class*	VISIT 1 1,2				VISIT 2 1,2				VISIT 3 1,2				VISIT 4 1,2							
					Zone	Easting	Northing	Dist. (m)	Direction		Date	Weather	Scav'ged?	Date	Weather	Scav'ged?	Date	Weather	Scav'ged?	Date	Weather	Scav'ged?								
05/07	6		small bird	fresh	17T	E 045 1961	N 476 2601	14	WSW	1	Date: July 6 Weather: warm Scav'ged? <input checked="" type="checkbox"/> -Y / <input type="checkbox"/> -N	Date: <del>July 9</del> Weather: <del>overcast</del> Scav'ged? <input type="checkbox"/> -Y / <input type="checkbox"/> -N	Date: <del>July 13</del> Weather: <del>warm</del> Scav'ged? <input type="checkbox"/> -Y / <input type="checkbox"/> -N	Date: <del>July 16</del> Weather: <del>warm</del> Scav'ged? <input type="checkbox"/> -Y / <input type="checkbox"/> -N	↳ 1 meter from orange state															
05/07	11		med. bird	fresh	17T	E 044 1967	N 476 3637	22	NE	1	Date: July 6 Weather: warm Scav'ged? <input type="checkbox"/> -Y / <input checked="" type="checkbox"/> -N	Date: July 9 Weather: overcast Scav'ged? <input type="checkbox"/> -Y / <input checked="" type="checkbox"/> -N	Date: July 13 Weather: warm Scav'ged? <input checked="" type="checkbox"/> -Y / <input type="checkbox"/> -N	Date: <del>July 16</del> Weather: <del>warm</del> Scav'ged? <input type="checkbox"/> -Y / <input type="checkbox"/> -N	↳ NE corner of gravel pad															
05/07	14		hoary bat	fresh	17T	E 044 1759	N 476 4814	38	SSW	1	Date: July 6 Weather: warm Scav'ged? <input type="checkbox"/> -Y / <input checked="" type="checkbox"/> -N	Date: July 9 Weather: overcast Scav'ged? <input type="checkbox"/> -Y / <input checked="" type="checkbox"/> -N	Date: July 13 Weather: warm Scav'ged? <input type="checkbox"/> -Y / <input checked="" type="checkbox"/> -N	Date: July 16 Weather: warm Scav'ged? <input type="checkbox"/> -Y / <input checked="" type="checkbox"/> -N	↳ corner of corn field, next to rock															
05/07	19		small bird	fresh	17T	E 044 2947	N 476 4938	27	S	1	Date: July 6 Weather: hot Scav'ged? <input type="checkbox"/> -Y / <input checked="" type="checkbox"/> -N	Date: July 9 Weather: sunny Scav'ged? <input type="checkbox"/> -Y / <input type="checkbox"/> -N	Date: July 13 Weather: warm Scav'ged? <input checked="" type="checkbox"/> -Y / <input type="checkbox"/> -N	Date: <del>July 16</del> Weather: <del>warm</del> Scav'ged? <input type="checkbox"/> -Y / <input type="checkbox"/> -N	↳ due South next to pink flag															
05/07	27		small bird	fresh	17T	E 043 001	N 476 5471	33	E	2	Date: July 6 Weather: hot Scav'ged? <input type="checkbox"/> -Y / <input checked="" type="checkbox"/> -N	Date: July 9 Weather: sunny Scav'ged? <input type="checkbox"/> -Y / <input checked="" type="checkbox"/> -N	Date: July 13 Weather: warm Scav'ged? <input type="checkbox"/> -Y / <input checked="" type="checkbox"/> -N	Date: July 16 Weather: warm Scav'ged? <input checked="" type="checkbox"/> -Y / <input checked="" type="checkbox"/> -N	↳ right of access road near yellow bag															

\* See visibility class key at top of page  
 1 N-Not scavenged includes partial scavenging in which sufficient carcass remains for subsequent scavenging (e.g. only head removed, 1/2 or more of body remaining)  
 2 Y-Scavenged indicates that the carcass is entirely missing or parts remaining (e.g. feathers, wings, entrails) would not likely be further scavenged

**Scavenger Trial Carcass Set-up & Daily Check Form**

Project No: 160961010

Project Name: Adelaide Wind Farm

YEAR: 2015

Personnel: Ken Edwards

SEASON: Summer

Weather: 23 21kph / NW

10%

0

0

on placement date TEMP (°C)

WIND

CLOUD

PPT

PPT (last 24 hrs)

speed/direction

% VEG. COVER	VEG. HEIGHT	VISIBILITY CLASS*
≥ 90% bare ground	≤ 15cm tall	Class 1 (Easy)
≥ 25% bare ground	≤ 15cm tall	Class 2 (Moderate)
≤ 25% bare ground	≤ 25% > 30cm tall	Class 3 (Difficult)
Little/no bare ground	≥ 25% > 30cm tall	Class 4 (Very difficult)

Date Placed dd/mm	Turbine No.	Carcass No.	Species	Condition fresh/frozen	UTM Coordinates			Position from turbine		Visib. Class*	VISIT 1 1,2	VISIT 2 1,2	VISIT 3 1,2	VISIT 4 1,2
					Zone	Easting	Northing	Dist. (m)	Direction					
19/07	6	1	med. bird	frozen	17T	E 044 2910	N 476 4954	13	E	1	Date: July 20 Weather: warm Scav'ged? <input type="checkbox"/> -Y / <input checked="" type="checkbox"/> -N	Date: July 23 Weather: warm Scav'ged? <input type="checkbox"/> -Y / <input checked="" type="checkbox"/> -N	Date: July 27 Weather: hot Scav'ged? <input type="checkbox"/> -Y / <input checked="" type="checkbox"/> -N	Date: July 30 Weather: hot Scav'ged? <input type="checkbox"/> -Y / <input checked="" type="checkbox"/> -N
19/07	1	2	small bird	frozen	17T	E 044 9618	N 476 2128	45	SW	2	Date: July 20 Weather: warm Scav'ged? <input type="checkbox"/> -Y / <input checked="" type="checkbox"/> -N	Date: July 23 Weather: warm Scav'ged? <input type="checkbox"/> -Y / <input checked="" type="checkbox"/> -N	Date: July 27 Weather: hot Scav'ged? <input type="checkbox"/> -Y / <input checked="" type="checkbox"/> -N	Date: July 30 Weather: hot Scav'ged? <input type="checkbox"/> -Y / <input checked="" type="checkbox"/> -N
19/07	12	3	hoary bat	frozen	17T	E 044 7877	N 476 3373	7	ENE	1	Date: July 20 Weather: warm Scav'ged? <input type="checkbox"/> -Y / <input checked="" type="checkbox"/> -N	Date: July 23 Weather: warm Scav'ged? <input type="checkbox"/> -Y / <input checked="" type="checkbox"/> -N	Date: <del>July 27</del>	Date: <del>July 30</del>
19/07	19	4	morning dove	thawed	17T	E 044 2933	N 476 4985	22	SW	1	Date: July 20 Weather: warm Scav'ged? <input type="checkbox"/> -Y / <input checked="" type="checkbox"/> -N	Date: July 23 Weather: warm Scav'ged? <input type="checkbox"/> -Y / <input checked="" type="checkbox"/> -N	Date: July 27 Weather: hot Scav'ged? <input type="checkbox"/> -Y / <input checked="" type="checkbox"/> -N	Date: July 30 Weather: hot Scav'ged? <input type="checkbox"/> -Y / <input checked="" type="checkbox"/> -N
19/07	12	5	small bird	thawed	17T	E 044 8305	N 476 3241	40	W	1	Date: July 20 Weather: warm Scav'ged? <input checked="" type="checkbox"/> -Y / <input type="checkbox"/> -N	Date: <del>July 23</del> Weather: <del>warm</del> Scav'ged? <input checked="" type="checkbox"/> -Y / <input type="checkbox"/> -N	Date: <del>July 27</del> Weather: <del>hot</del> Scav'ged? <input checked="" type="checkbox"/> -Y / <input type="checkbox"/> -N	Date: <del>July 30</del> Weather: <del>hot</del> Scav'ged? <input checked="" type="checkbox"/> -Y / <input type="checkbox"/> -N
6						E	N				Date: <del>July 20</del> Weather: <del>warm</del> Scav'ged? <input checked="" type="checkbox"/> -Y / <input type="checkbox"/> -N	Date: <del>July 23</del> Weather: <del>warm</del> Scav'ged? <input checked="" type="checkbox"/> -Y / <input type="checkbox"/> -N	Date: <del>July 27</del> Weather: <del>hot</del> Scav'ged? <input checked="" type="checkbox"/> -Y / <input type="checkbox"/> -N	Date: <del>July 30</del> Weather: <del>hot</del> Scav'ged? <input checked="" type="checkbox"/> -Y / <input type="checkbox"/> -N
						E	N				Date: <del>July 20</del> Weather: <del>warm</del> Scav'ged? <input checked="" type="checkbox"/> -Y / <input type="checkbox"/> -N	Date: <del>July 23</del> Weather: <del>warm</del> Scav'ged? <input checked="" type="checkbox"/> -Y / <input type="checkbox"/> -N	Date: <del>July 27</del> Weather: <del>hot</del> Scav'ged? <input checked="" type="checkbox"/> -Y / <input type="checkbox"/> -N	Date: <del>July 30</del> Weather: <del>hot</del> Scav'ged? <input checked="" type="checkbox"/> -Y / <input type="checkbox"/> -N
						E	N				Date: <del>July 20</del> Weather: <del>warm</del> Scav'ged? <input checked="" type="checkbox"/> -Y / <input type="checkbox"/> -N	Date: <del>July 23</del> Weather: <del>warm</del> Scav'ged? <input checked="" type="checkbox"/> -Y / <input type="checkbox"/> -N	Date: <del>July 27</del> Weather: <del>hot</del> Scav'ged? <input checked="" type="checkbox"/> -Y / <input type="checkbox"/> -N	Date: <del>July 30</del> Weather: <del>hot</del> Scav'ged? <input checked="" type="checkbox"/> -Y / <input type="checkbox"/> -N
						E	N				Date: <del>July 20</del> Weather: <del>warm</del> Scav'ged? <input checked="" type="checkbox"/> -Y / <input type="checkbox"/> -N	Date: <del>July 23</del> Weather: <del>warm</del> Scav'ged? <input checked="" type="checkbox"/> -Y / <input type="checkbox"/> -N	Date: <del>July 27</del> Weather: <del>hot</del> Scav'ged? <input checked="" type="checkbox"/> -Y / <input type="checkbox"/> -N	Date: <del>July 30</del> Weather: <del>hot</del> Scav'ged? <input checked="" type="checkbox"/> -Y / <input type="checkbox"/> -N
						E	N				Date: <del>July 20</del> Weather: <del>warm</del> Scav'ged? <input checked="" type="checkbox"/> -Y / <input type="checkbox"/> -N	Date: <del>July 23</del> Weather: <del>warm</del> Scav'ged? <input checked="" type="checkbox"/> -Y / <input type="checkbox"/> -N	Date: <del>July 27</del> Weather: <del>hot</del> Scav'ged? <input checked="" type="checkbox"/> -Y / <input type="checkbox"/> -N	Date: <del>July 30</del> Weather: <del>hot</del> Scav'ged? <input checked="" type="checkbox"/> -Y / <input type="checkbox"/> -N

\* See visibility class key at top of page

<sup>1</sup> N-Not scavenged includes partial scavenging in which sufficient carcass remains for subsequent scavenging (e.g. only head removed, 1/2 or more of body remaining)

<sup>2</sup> Y-Scavenged indicates that the carcass is entirely missing or parts remaining (e.g. feathers, wings, entrails) would not likely be further scavenged



## Scavenger Trial Carcass Set-up & Daily Check Form

Project No: 160961010

Project Name: Adelaide Wind Farm

YEAR: 2015

Personnel: Ken EdwardsSEASON: summerWeather: 24 6km/h NE

on placement date TEMP (°C)

WIND

CLOUD

PPT

PPT (last 24 hrs)

speed/direction

% VEG. COVER	VEG. HEIGHT	VISIBILITY CLASS*
≥ 90% bare ground	≤ 15cm tall	Class 1 (Easy)
≥ 25% bare ground	≤ 15cm tall	Class 2 (Moderate)
≤ 25% bare ground	≤ 25% > 30cm tall	Class 3 (Difficult)
Little/no bare ground	≥ 25% > 30cm tall	Class 4 (Very difficult)

Date Placed dd/mm	Turbine No.	Carcass No.	Species	Condition fresh/frozen	UTM Coordinates		Position from turbine		Visib. Class*	VISIT 1 1,2	VISIT 2 1,2	VISIT 3 1,2	VISIT 4 1,2	
					Zone	Easting	Northing	Dist. (m)						Direction
06/08	27	1	med bird	Fresh	17T	E 044 7827	N 476 3364	22	SE	1	Date: Aug 7 Weather: warm Scav'ged? <input type="checkbox"/> -Y / <input checked="" type="checkbox"/> -N	Date: Aug 10 Weather: rain/overcast Scav'ged? <input type="checkbox"/> -Y / <input checked="" type="checkbox"/> -N	Date: Aug 13 Weather: warm Scav'ged? <input type="checkbox"/> -Y / <input checked="" type="checkbox"/> -N	Date: Aug 17 Weather: hot Scav'ged? <input type="checkbox"/> -Y / <input checked="" type="checkbox"/> -N
06/08	22	2	small bird	Fresh	"	E 043 8313	N 476 3200	5	NE	1	Date: Aug 7 Weather: warm Scav'ged? <input type="checkbox"/> -Y / <input checked="" type="checkbox"/> -N	Date: Aug 10 Weather: " " Scav'ged? <input type="checkbox"/> -Y / <input checked="" type="checkbox"/> -N	Date: Aug 13 Weather: warm Scav'ged? <input type="checkbox"/> -Y / <input checked="" type="checkbox"/> -N	Date: Aug 17 Weather: hot Scav'ged? <input type="checkbox"/> -Y / <input checked="" type="checkbox"/> -N
06/08	19	3	hoary bat	Fresh	"	E 044 2751	N 476 4955	10	S	2	Date: Aug 7 Weather: warm Scav'ged? <input type="checkbox"/> -Y / <input checked="" type="checkbox"/> -N	Date: Aug 10 Weather: " " Scav'ged? <input type="checkbox"/> -Y / <input checked="" type="checkbox"/> -N	Date: Aug 13 Weather: warm Scav'ged? <input type="checkbox"/> -Y / <input checked="" type="checkbox"/> -N	Date: Aug 17 Weather: hot Scav'ged? <input type="checkbox"/> -Y / <input checked="" type="checkbox"/> -N
06/08	14	4	small bird	Fresh	1.	E 044 7168	N 476 4907	43	S	1	Date: Aug 7 Weather: warm Scav'ged? <input type="checkbox"/> -Y / <input checked="" type="checkbox"/> -N	Date: Aug 10 Weather: rain/overcast Scav'ged? <input type="checkbox"/> -Y / <input checked="" type="checkbox"/> -N	Date: Aug 13 Weather: clear/warm Scav'ged? <input type="checkbox"/> -Y / <input checked="" type="checkbox"/> -N	Date: <del>Aug 17</del> Weather: <del>hot</del> Scav'ged? <input type="checkbox"/> -Y / <input checked="" type="checkbox"/> -N
06/08	6	5	med. bird	Fresh	"	E 045 1984	N 476 2630	19	N	1	Date: Aug 7 Weather: warm Scav'ged? <input type="checkbox"/> -Y / <input checked="" type="checkbox"/> -N	Date: Aug 10 Weather: rain/overcast Scav'ged? <input type="checkbox"/> -Y / <input checked="" type="checkbox"/> -N	Date: Aug 13 Weather: cool Scav'ged? <input type="checkbox"/> -Y / <input checked="" type="checkbox"/> -N	Date: <del>Aug 17</del> Weather: <del>hot</del> Scav'ged? <input type="checkbox"/> -Y / <input checked="" type="checkbox"/> -N
						E	N				Date:	Date:	Date:	Date:
						E	N				Date:	Date:	Date:	Date:
						E	N				Date:	Date:	Date:	Date:
						E	N				Date:	Date:	Date:	Date:
						E	N				Date:	Date:	Date:	Date:
						E	N				Date:	Date:	Date:	Date:
						E	N				Date:	Date:	Date:	Date:

\* See visibility class key at top of page

1 N-Not scavenged includes partial scavenging in which sufficient carcass remains for subsequent scavenging (e.g. only head removed, 1/2 or more of body remaining)

2 Y-Scavenged indicates that the carcass is entirely missing or parts remaining (e.g. feathers, wings, entrails) would not likely be further scavenged

PAGE 1 OF 4

Print Name & Initial: Ken Edwards KE

(field notes author)

Quality Control:

Print Name & Initial: Anna Corrigan AC

(field notes QA/QC personnel)

This form is complete  & legible 

FORM / REV: 2015-04-28



**Scavenger Trial Carcass Set-up & Daily Check Form**

Project No: 160961010 Project Name: Adelaide Wind Farm  
 YEAR: 2015 Personnel: Ken Edwards  
 SEASON: Summer  
 Weather: 26 9 1 5 40% 0 0  
 on placement date TEMP (°C) WIND CLOUD PPT PPT (last 24 hrs)  
 speed/direction

% VEG. COVER	VEG. HEIGHT	VISIBILITY CLASS*
≥ 90% bare ground	≤ 15cm tall	Class 1 (Easy)
≥ 25% bare ground	≤ 15cm tall	Class 2 (Moderate)
≤ 25% bare ground	≤ 25% > 30cm tall	Class 3 (Difficult)
Little/no bare ground	≥ 25% > 30cm tall	Class 4 (Very difficult)

Date Placed dd/mm	Turbine No.	Carcass No.	Species	Condition fresh/frozen	UTM Coordinates		Position from turbine		Visib. Class*	VISIT 1 1,2	VISIT 2 1,2	VISIT 3 1,2	VISIT 4 1,2	
					Zone	Easting	Northing	Dist. (m)						Direction
19/08	7	1	sm. bird	Frozen	17T	E 044 9618	N 476 2151	45	W	1	Date: Aug 20 Weather: mild Scav'ged? <input type="checkbox"/> -Y / <input checked="" type="checkbox"/> -N	Date: Aug 24 Weather: Mild Scav'ged? <input type="checkbox"/> -Y / <input checked="" type="checkbox"/> -N	Date: Aug 27 Weather: mild Scav'ged? <input type="checkbox"/> -Y / <input checked="" type="checkbox"/> -N	Date: Aug 31 Weather: warm Scav'ged? <input type="checkbox"/> -Y / <input checked="" type="checkbox"/> -N
19/08	11	2	sm. bird	Frozen	17T	E 044 9166	N 476 3614	17	E	1	Date: Aug 20 Weather: J11 Scav'ged? <input type="checkbox"/> -Y / <input checked="" type="checkbox"/> -N	Date: Aug 24 Weather: Mild Scav'ged? <input type="checkbox"/> -Y / <input type="checkbox"/> -N	<del>Date: Aug 27 Weather: J11 Scav'ged? <input type="checkbox"/>-Y / <input type="checkbox"/>-N</del>	<del>Date: Aug 31 Weather: J11 Scav'ged? <input type="checkbox"/>-Y / <input type="checkbox"/>-N</del>
19/08	17	3	med. bird	Frozen	17T	E 044 4502	N 476 5069	3	W	1	Date: Aug 20 Weather: J11 Scav'ged? <input type="checkbox"/> -Y / <input checked="" type="checkbox"/> -N	Date: Aug 24 Weather: J11 Scav'ged? <input type="checkbox"/> -Y / <input type="checkbox"/> -N	<del>Date: Aug 27 Weather: J11 Scav'ged? <input type="checkbox"/>-Y / <input type="checkbox"/>-N</del>	<del>Date: Aug 31 Weather: J11 Scav'ged? <input type="checkbox"/>-Y / <input type="checkbox"/>-N</del>
19/08	19	4	eastern red	Fresh	17T	E 044 2938	N 476 4929	37	SW	2	Date: Aug 20 Weather: J11 Scav'ged? <input type="checkbox"/> -Y / <input checked="" type="checkbox"/> -N	Date: Aug 24 Weather: J11 Scav'ged? <input type="checkbox"/> -Y / <input checked="" type="checkbox"/> -N	Date: Aug 27 Weather: J11 Scav'ged? <input type="checkbox"/> -Y / <input type="checkbox"/> -N	Date: Aug 31 Weather: J11 Scav'ged? <input type="checkbox"/> -Y / <input type="checkbox"/> -N
19/08	27	5	sm. bird	Fresh	17T	E 044 6011	N 476 5459	45	E	1	Date: Aug 20 Weather: J11 Scav'ged? <input type="checkbox"/> -Y / <input checked="" type="checkbox"/> -N	Date: Aug 24 Weather: J11 Scav'ged? <input type="checkbox"/> -Y / <input checked="" type="checkbox"/> -N	Date: Aug 27 Weather: J11 Scav'ged? <input checked="" type="checkbox"/> -Y / <input type="checkbox"/> -N	Date: Aug 31 Weather: J11 Scav'ged? <input type="checkbox"/> -Y / <input type="checkbox"/> -N
						E	N				Date:	Date:	Date:	Date:
						E	N				Date:	Date:	Date:	Date:
						E	N				Date:	Date:	Date:	Date:
						E	N				Date:	Date:	Date:	Date:
						E	N				Date:	Date:	Date:	Date:
						E	N				Date:	Date:	Date:	Date:
						E	N				Date:	Date:	Date:	Date:
						E	N				Date:	Date:	Date:	Date:



## Scavenger Trial Carcass Set-up & Daily Check Form

Project No: 160961010Project Name: Adelaide Wind Farm

YEAR: 2015

Personnel: Ken EdwardsSEASON: FallWeather: 27 11k / SW

☉

☉

☉

on placement date TEMP (°C)

WIND

CLOUD

PPT

PPT (last 24 hrs)

speed/direction

% VEG. COVER	VEG. HEIGHT	VISIBILITY CLASS*
≥ 90% bare ground	≤ 15cm tall	Class 1 (Easy)
≥ 25% bare ground	≤ 15cm tall	Class 2 (Moderate)
≤ 25% bare ground	≤ 25% > 30cm tall	Class 3 (Difficult)
Little/no bare ground	≥ 25% > 30cm tall	Class 4 (Very difficult)

Date Placed dd/mm	Turbine No.	Carcass No.	Species	Condition fresh/frozen	UTM Coordinates			Position from turbine		Visib. Class*	VISIT 1 1,2	VISIT 2 1,2	VISIT 3 1,2	VISIT 4 1,2
					Zone	Easting	Northing	Dist. (m)	Direction					
16/09	22	1	med bird	Fresh	17T	E 043 8337	N 476 3202	25	E	2	Date: <u>Sept. 17</u> Weather: <u>sunny</u> Scav'ged? <input type="checkbox"/> -Y/ <input checked="" type="checkbox"/> -N	Date: <u>Sept 21</u> Weather: <u>sunny</u> Scav'ged? <input checked="" type="checkbox"/> -Y/ <input type="checkbox"/> -N	<del>Date: _____ Weather: _____ Scav'ged? <input type="checkbox"/>-Y/<input type="checkbox"/>-N</del>	<del>Date: _____ Weather: _____ Scav'ged? <input type="checkbox"/>-Y/<input type="checkbox"/>-N</del>
			↳ flag											
16/09	19	2	Hoary bat	"	17T	E 044 2956	N 476 4959	15	SE	1	Date: <u>Sept. 17</u> Weather: <u>sunny</u> Scav'ged? <input type="checkbox"/> -Y/ <input checked="" type="checkbox"/> -N	Date: <u>Sept 21</u> Weather: <u>sunny</u> Scav'ged? <input checked="" type="checkbox"/> -Y/ <input type="checkbox"/> -N	<del>Date: _____ Weather: _____ Scav'ged? <input type="checkbox"/>-Y/<input type="checkbox"/>-N</del>	<del>Date: _____ Weather: _____ Scav'ged? <input type="checkbox"/>-Y/<input type="checkbox"/>-N</del>
			↳ flag											
16/09	17	3	med bird	"	17T	E 044 4504	N 476 5069	3	W	1	Date: <u>Sept. 17</u> Weather: <u>sunny</u> Scav'ged? <input type="checkbox"/> -Y/ <input checked="" type="checkbox"/> -N	Date: <u>Sept. 21</u> Weather: <u>sunny</u> Scav'ged? <input checked="" type="checkbox"/> -Y/ <input type="checkbox"/> -N	Date: <u>Sept. 24</u> Weather: <u>sunny</u> Scav'ged? <input checked="" type="checkbox"/> -Y/ <input checked="" type="checkbox"/> -N	Date: <u>Sept. 28</u> Weather: <u>sunny</u> Scav'ged? <input checked="" type="checkbox"/> -Y/ <input checked="" type="checkbox"/> -N
			↳ flag											
16/09	12	4	Big Brown	"	17T	E 044 7832	N 476 3364	45	W	2	Date: <u>Sept. 17</u> Weather: <u>sunny</u> Scav'ged? <input type="checkbox"/> -Y/ <input checked="" type="checkbox"/> -N	Date: <u>Sept. 21</u> Weather: <u>sunny</u> Scav'ged? <input checked="" type="checkbox"/> -Y/ <input type="checkbox"/> -N	<del>Date: _____ Weather: _____ Scav'ged? <input type="checkbox"/>-Y/<input type="checkbox"/>-N</del>	<del>Date: _____ Weather: _____ Scav'ged? <input type="checkbox"/>-Y/<input type="checkbox"/>-N</del>
			↳ flag											
16/09	7	5	Med. Bird	"	17T	E 044 7832	N 476 3364	20	NW	1	Date: <u>Sept. 17</u> Weather: <u>sunny</u> Scav'ged? <input type="checkbox"/> -Y/ <input checked="" type="checkbox"/> -N	Date: <u>Sept. 21</u> Weather: <u>sunny</u> Scav'ged? <input checked="" type="checkbox"/> -Y/ <input type="checkbox"/> -N	<del>Date: _____ Weather: _____ Scav'ged? <input type="checkbox"/>-Y/<input type="checkbox"/>-N</del>	<del>Date: _____ Weather: _____ Scav'ged? <input type="checkbox"/>-Y/<input type="checkbox"/>-N</del>
			↳ flag											

\* See visibility class key at top of page

1 N-Not scavenged includes partial scavenging in which sufficient carcass remains for subsequent scavenging (e.g. only head removed, 1/2 or more of body remaining)

2 Y-Scavenged indicates that the carcass is entirely missing or parts remaining (e.g. feathers, wings, entrails) would not likely be further scavenged

PAGE 1 OF 4Print Name & Initial: Ken Edwards  
(field notes author)

Quality Control:

Print Name & Initial: Anna Corinan  
(field notes QA/QC personnel)This form is complete  & legible



## Scavenger Trial Carcass Set-up & Daily Check Form

 Project No: 160961016

 Project Name: Adelaide Wind Farm

YEAR: 2015

 Personnel: Ken Edwards

 SEASON: Fall

 Weather: 25 6km/h / N

☐ ☐ ☐

 on placement date TEMP (°C) WIND speed/direction  
 CLOUD PPT PPT (last 24 hrs)

% VEG. COVER	VEG. HEIGHT	VISIBILITY CLASS*
≥ 90% bare ground	≤ 15cm tall	Class 1 (Easy)
≥ 25% bare ground	≤ 15cm tall	Class 2 (Moderate)
≤ 25% bare ground	≤ 25% > 30cm tall	Class 3 (Difficult)
Little/no bare ground	≥ 25% > 30cm tall	Class 4 (Very difficult)

Date Placed dd/mm	Turbine No.	Carcass No.	Species	Condition fresh/frozen	UTM Coordinates			Position from turbine		Visib. Class*	VISIT 1 1,2	VISIT 2 1,2	VISIT 3 1,2	VISIT 4 1,2
					Zone	Easting	Northing	Dist. (m)	Direction					
23/09	6	1	sm. bird	fresh	E 17T	E 045 1964	N 476 2567	40	S	2	Date: <u>Sept. 24</u> Weather: <u>sunny</u> Scav'ged? <input type="checkbox"/> -Y/ <input checked="" type="checkbox"/> -N	Date: <u>Sept 28</u> Weather: <u>cloudy</u> Scav'ged? <input type="checkbox"/> -Y/ <input checked="" type="checkbox"/> -N	Date: <u>Oct 1</u> Weather: <u>cloud/clear</u> Scav'ged? <input type="checkbox"/> -Y/ <input type="checkbox"/> -N	Date: <del>                    </del> Weather: <del>                    </del> Scav'ged? <input type="checkbox"/> -Y/ <input type="checkbox"/> -N
			↳ flag		E		N				Date: <del>                    </del> Weather: <del>                    </del> Scav'ged? <input type="checkbox"/> -Y/ <input type="checkbox"/> -N	Date: <del>                    </del> Weather: <del>                    </del> Scav'ged? <input type="checkbox"/> -Y/ <input type="checkbox"/> -N	Date: <del>                    </del> Weather: <del>                    </del> Scav'ged? <input type="checkbox"/> -Y/ <input type="checkbox"/> -N	Date: <del>                    </del> Weather: <del>                    </del> Scav'ged? <input type="checkbox"/> -Y/ <input type="checkbox"/> -N
23/09	11	2	med. bird	"	E 17T	E 044 9161	N 476 3603	20	SE	1	Date: <u>Sept 24</u> Weather: <u>sunny</u> Scav'ged? <input checked="" type="checkbox"/> -Y/ <input type="checkbox"/> -N	Date: <del>                    </del> Weather: <del>                    </del> Scav'ged? <input type="checkbox"/> -Y/ <input type="checkbox"/> -N	Date: <del>                    </del> Weather: <del>                    </del> Scav'ged? <input type="checkbox"/> -Y/ <input type="checkbox"/> -N	Date: <del>                    </del> Weather: <del>                    </del> Scav'ged? <input type="checkbox"/> -Y/ <input type="checkbox"/> -N
			↳ flag		E		N				Date: <del>                    </del> Weather: <del>                    </del> Scav'ged? <input type="checkbox"/> -Y/ <input type="checkbox"/> -N	Date: <del>                    </del> Weather: <del>                    </del> Scav'ged? <input type="checkbox"/> -Y/ <input type="checkbox"/> -N	Date: <del>                    </del> Weather: <del>                    </del> Scav'ged? <input type="checkbox"/> -Y/ <input type="checkbox"/> -N	Date: <del>                    </del> Weather: <del>                    </del> Scav'ged? <input type="checkbox"/> -Y/ <input type="checkbox"/> -N
23/09	14	3	sm. bird	"	E 17T	E 044 7173	N 476 4843	5	SE	2	Date: <u>Sept. 24</u> Weather: <u>sunny</u> Scav'ged? <input type="checkbox"/> -Y/ <input checked="" type="checkbox"/> -N	Date: <u>Sept. 28</u> Weather: <u>cloudy</u> Scav'ged? <input type="checkbox"/> -Y/ <input checked="" type="checkbox"/> -N	Date: <u>Oct 1</u> Weather: <u>clear</u> Scav'ged? <input type="checkbox"/> -Y/ <input checked="" type="checkbox"/> -N	Date: <u>Oct 5</u> Weather: <u>mild</u> Scav'ged? <input type="checkbox"/> -Y/ <input checked="" type="checkbox"/> -N
			↳ flag		E		N				Date: <del>                    </del> Weather: <del>                    </del> Scav'ged? <input type="checkbox"/> -Y/ <input type="checkbox"/> -N	Date: <del>                    </del> Weather: <del>                    </del> Scav'ged? <input type="checkbox"/> -Y/ <input type="checkbox"/> -N	Date: <del>                    </del> Weather: <del>                    </del> Scav'ged? <input type="checkbox"/> -Y/ <input type="checkbox"/> -N	Date: <del>                    </del> Weather: <del>                    </del> Scav'ged? <input type="checkbox"/> -Y/ <input type="checkbox"/> -N
23/09	20	4	hoary bat	"	E 17T	E 044 0236	N 476 5226	15	NW	1	Date: <u>Sept. 24</u> Weather: <u>sunny</u> Scav'ged? <input type="checkbox"/> -Y/ <input checked="" type="checkbox"/> -N	Date: <u>Sept 28</u> Weather: <u>cloudy</u> Scav'ged? <input type="checkbox"/> -Y/ <input checked="" type="checkbox"/> -N	Date: <u>Oct 1</u> Weather: <u>clear</u> Scav'ged? <input type="checkbox"/> -Y/ <input checked="" type="checkbox"/> -N	Date: <u>Oct 5</u> Weather: <u>mild</u> Scav'ged? <input type="checkbox"/> -Y/ <input checked="" type="checkbox"/> -N
			↳ flag		E		N				Date: <del>                    </del> Weather: <del>                    </del> Scav'ged? <input type="checkbox"/> -Y/ <input type="checkbox"/> -N	Date: <del>                    </del> Weather: <del>                    </del> Scav'ged? <input type="checkbox"/> -Y/ <input type="checkbox"/> -N	Date: <del>                    </del> Weather: <del>                    </del> Scav'ged? <input type="checkbox"/> -Y/ <input type="checkbox"/> -N	Date: <del>                    </del> Weather: <del>                    </del> Scav'ged? <input type="checkbox"/> -Y/ <input type="checkbox"/> -N
23/09	27	5	med. bird	"	E 17T	E 043 5993	N 476 5498	30	E	2	Date: <u>Sept. 24</u> Weather: <u>sunny</u> Scav'ged? <input type="checkbox"/> -Y/ <input checked="" type="checkbox"/> -N	Date: <u>Sept 28</u> Weather: <u>cloudy</u> Scav'ged? <input checked="" type="checkbox"/> -Y/ <input type="checkbox"/> -N	Date: <del>                    </del> Weather: <del>                    </del> Scav'ged? <input type="checkbox"/> -Y/ <input type="checkbox"/> -N	Date: <del>                    </del> Weather: <del>                    </del> Scav'ged? <input type="checkbox"/> -Y/ <input type="checkbox"/> -N
			↳ flag		E		N				Date: <del>                    </del> Weather: <del>                    </del> Scav'ged? <input type="checkbox"/> -Y/ <input type="checkbox"/> -N	Date: <del>                    </del> Weather: <del>                    </del> Scav'ged? <input type="checkbox"/> -Y/ <input type="checkbox"/> -N	Date: <del>                    </del> Weather: <del>                    </del> Scav'ged? <input type="checkbox"/> -Y/ <input type="checkbox"/> -N	Date: <del>                    </del> Weather: <del>                    </del> Scav'ged? <input type="checkbox"/> -Y/ <input type="checkbox"/> -N

\* See visibility class key at top of page

1 N-Not scavenged includes partial scavenging in which sufficient carcass remains for subsequent scavenging (e.g. only head removed, 1/2 or more of body remaining)

2 Y-Scavenged indicates that the carcass is entirely missing or parts remaining (e.g. feathers, wings, entrails) would not likely be further scavenged

PAGE 2 OF 4

 Print Name & Initial: Ken Edwards KE  
 (field notes author)

Quality Control:

 This form is complete  & legible 

 Print Name & Initial: Anna Corrigan AC  
 (field notes QA/QC personnel)

## Scavenger Trial Carcass Set-up & Daily Check Form

 Project No: 160961010

 Project Name: Adelaide Wind Farm

YEAR: 2015

 Personnel: Ken Edwards

 SEASON: Fall

 Weather: 16 17km/h / NE 30% 0 0

on placement date TEMP (°C) WIND speed/direction CLOUD PPT PPT (last 24 hrs)

% VEG. COVER	VEG. HEIGHT	VISIBILITY CLASS*
≥ 90% bare ground	≤ 15cm tall	Class 1 (Easy)
≥ 25% bare ground	≤ 15cm tall	Class 2 (Moderate)
≤ 25% bare ground	≤ 25% > 30cm tall	Class 3 (Difficult)
Little/no bare ground	≥ 25% > 30cm tall	Class 4 (Very difficult)

Date Placed dd/mm	Turbine No.	Carcass No.	Species	Condition fresh/frozen	UTM Coordinates			Position from turbine		Visib. Class*	VISIT 1 1,2	VISIT 2 1,2	VISIT 3 1,2	VISIT 4 1,2
					Zone	Easting	Northing	Dist. (m)	Direction					
30/09	6	1	sm. bird	frozen	17T	E 045 1984	N 476 2590	16	SW	1	Date: <u>Oct 1</u> Weather: <u>cold/clear</u> Scav'ged? <input type="checkbox"/> -Y/ <input checked="" type="checkbox"/> -N	Date: <u>Oct 5</u> Weather: <u>overcast</u> Scav'ged? <input type="checkbox"/> -Y/ <input checked="" type="checkbox"/> -N	Date: <u>Oct 8</u> Weather: <u>sunny</u> Scav'ged? <input type="checkbox"/> -Y/ <input checked="" type="checkbox"/> -N	Date: <u>Oct 12</u> Weather: <u>sunny</u> Scav'ged? <input type="checkbox"/> -Y/ <input checked="" type="checkbox"/> -N
			↳ flag								Date:	Date:	Date:	Date:
<del>30/09</del>	<del>2</del>	<del>1</del>	<del>silver haired</del>	<del>frozen</del>	<del>17T</del>	<del>E 044 1988</del>	<del>N 476 3620</del>	<del>40</del>	<del>NE</del>	<del>2</del>	<del>Date: <u>Oct 1</u></del> <del>Weather: <u>cold/clear</u></del> <del>Scav'ged? <input type="checkbox"/>-Y/<input checked="" type="checkbox"/>-N</del>	<del>Date: <u>Oct 5</u></del> <del>Weather: <u>overcast</u></del> <del>Scav'ged? <input type="checkbox"/>-Y/<input checked="" type="checkbox"/>-N</del>	<del>Date: <u>Oct 8</u></del> <del>Weather: <u>overcast</u></del> <del>Scav'ged? <input type="checkbox"/>-Y/<input checked="" type="checkbox"/>-N</del>	<del>Date: <u>Oct 12</u></del> <del>Weather: <u>overcast</u></del> <del>Scav'ged? <input type="checkbox"/>-Y/<input checked="" type="checkbox"/>-N</del>
			<del>South side of access rd.</del>								Date:	Date:	Date:	Date:
30/09	12	2	silver haired	frozen	17T	E 044 7837	N 476 3363	40	NW	2	Date: <u>Oct 1</u> Weather: <u>cold/clear</u> Scav'ged? <input type="checkbox"/> -Y/ <input checked="" type="checkbox"/> -N	Date: <u>Oct 5</u> Weather: <u>overcast</u> Scav'ged? <input type="checkbox"/> -Y/ <input checked="" type="checkbox"/> -N	Date: <del>Oct 8</del> Weather: <del>overcast</del> Scav'ged? <input type="checkbox"/> -Y/ <input checked="" type="checkbox"/> -N	Date: <del>Oct 12</del> Weather: <del>overcast</del> Scav'ged? <input type="checkbox"/> -Y/ <input checked="" type="checkbox"/> -N
			↳ North side of access rd. (fabric)								Date:	Date:	Date:	Date:
30/09	17	3	small bird	fresh	17T	E 044 4508	N 476 5060	3	S	2	Date: <u>Oct 1</u> Weather: <u>clear</u> Scav'ged? <input type="checkbox"/> -Y/ <input checked="" type="checkbox"/> -N	Date: <u>Oct 5</u> Weather: <u>overcast</u> Scav'ged? <input type="checkbox"/> -Y/ <input checked="" type="checkbox"/> -N	Date: <del>Oct 8</del> Weather: <del>overcast</del> Scav'ged? <input type="checkbox"/> -Y/ <input checked="" type="checkbox"/> -N	Date: <del>Oct 12</del> Weather: <del>overcast</del> Scav'ged? <input type="checkbox"/> -Y/ <input checked="" type="checkbox"/> -N
			↳ flag								Date:	Date:	Date:	Date:
			↳ Big rock								Date:	Date:	Date:	Date:
30/09	19	4	sm. bird	fresh	17T	E 046 2959	N 476 4968	35	E	1	Date: <u>Oct 1</u> Weather: <u>clear</u> Scav'ged? <input type="checkbox"/> -Y/ <input checked="" type="checkbox"/> -N	Date: <u>Oct 5</u> Weather: <u>overcast</u> Scav'ged? <input type="checkbox"/> -Y/ <input checked="" type="checkbox"/> -N	Date: <del>Oct 8</del> Weather: <del>overcast</del> Scav'ged? <input type="checkbox"/> -Y/ <input checked="" type="checkbox"/> -N	Date: <del>Oct 12</del> Weather: <del>overcast</del> Scav'ged? <input type="checkbox"/> -Y/ <input checked="" type="checkbox"/> -N
											Date:	Date:	Date:	Date:
30/09	22	5	med. bird	fresh	17T	E 043 8322	N 476 3231	25	NE	2	Date: <u>Oct 1</u> Weather: <u>clear</u> Scav'ged? <input type="checkbox"/> -Y/ <input checked="" type="checkbox"/> -N	Date: <u>Oct 5</u> Weather: <u>overcast</u> Scav'ged? <input type="checkbox"/> -Y/ <input checked="" type="checkbox"/> -N	Date: <u>Oct 8</u> Weather: <u>sunny</u> Scav'ged? <input type="checkbox"/> -Y/ <input checked="" type="checkbox"/> -N	Date: <del>Oct 12</del> Weather: <del>overcast</del> Scav'ged? <input type="checkbox"/> -Y/ <input checked="" type="checkbox"/> -N
			↳ flag								Date:	Date:	Date:	Date:

\* See visibility class key at top of page

1 N-Not scavenged includes partial scavenging in which sufficient carcass remains for subsequent scavenging (e.g. only head removed, 1/2 or more of body remaining)

2 Y-Scavenged indicates that the carcass is entirely missing or parts remaining (e.g. feathers, wings, entrails) would not likely be further scavenged

 PAGE 3 OF 4

 Print Name & Initial: Ken Edwards KE  
(field notes author)

Quality Control:

 Print Name & Initial: Anna Carrigan AC  
(field notes QA/QC personnel)

 This form is complete  & legible



## Scavenger Trial Carcass Set-up & Daily Check Form

Project No: 180961010Project Name: Adelaide Wind FarmYEAR: 2015Personnel: Ken EdwardsSEASON: FallAnna CorriganWeather: 19 km/h / NW 40%

on placement date TEMP (°C)

WIND

CLOUD

PPT

PPT (last 24 hrs)

speed/direction

% VEG. COVER	VEG. HEIGHT	VISIBILITY CLASS*
≥ 90% bare ground	≤ 15cm tall	Class 1 (Easy)
≥ 25% bare ground	≤ 15cm tall	Class 2 (Moderate)
≤ 25% bare ground	≤ 25% > 30cm tall	Class 3 (Difficult)
Little/no bare ground	≥ 25% > 30cm tall	Class 4 (Very difficult)

Date Placed dd/mm	Turbine No.	Carcass No.	Species	Condition fresh/frozen	UTM Coordinates			Position from turbine		Visib. Class*	VISIT 1 1,2					
					Zone	Easting	Northing	Dist. (m)	Direction		Date:	Weather:	Scav'ged? <input type="checkbox"/> -Y/ <input type="checkbox"/> -N	Date:	Weather:	Scav'ged? <input type="checkbox"/> -Y/ <input type="checkbox"/> -N
07/10	21	1	sm. bird	fresh	17T	E 043 5962	N 476 5461	S	5	2	Date: <u>Oct 8</u> Weather: <u>sunny</u> Scav'ged? <input type="checkbox"/> -Y/ <input checked="" type="checkbox"/> -N	Date: <u>Oct 12</u> Weather: <u>cloudy</u> Scav'ged? <input type="checkbox"/> -Y/ <input checked="" type="checkbox"/> -N	Date: <u>Oct 15</u> Weather: <u>clear</u> Scav'ged? <input type="checkbox"/> -Y/ <input checked="" type="checkbox"/> -N	Date: <u>October 19</u> Weather: <u>Clear</u> Scav'ged? <input checked="" type="checkbox"/> -Y/ <input type="checkbox"/> -N		
			↳ flag								Date:	Weather:	Scav'ged? <input type="checkbox"/> -Y/ <input type="checkbox"/> -N	Date:	Weather:	Scav'ged? <input type="checkbox"/> -Y/ <input type="checkbox"/> -N
07/10	20	2	sm. bird	fresh	17T	E 044 0237	N 476 5222	W	22	1	Date: <u>Oct 8</u> Weather: <u>sunny</u> Scav'ged? <input type="checkbox"/> -Y/ <input checked="" type="checkbox"/> -N	Date: <u>Oct 12</u> Weather: <u>sunny</u> Scav'ged? <input type="checkbox"/> -Y/ <input checked="" type="checkbox"/> -N	Date: <u>Oct 15</u> Weather: <u>clear</u> Scav'ged? <input type="checkbox"/> -Y/ <input checked="" type="checkbox"/> -N	Date: <u>October 19</u> Weather: <u>Clear</u> Scav'ged? <input type="checkbox"/> -Y/ <input checked="" type="checkbox"/> -N		
			↳ flag								Date:	Weather:	Scav'ged? <input type="checkbox"/> -Y/ <input type="checkbox"/> -N	Date:	Weather:	Scav'ged? <input type="checkbox"/> -Y/ <input type="checkbox"/> -N
07/10	14	3	"	"	HT	E 044 7175	N 476 4815	S	37	1	Date: <u>Oct 8</u> Weather: <u>sunny</u> Scav'ged? <input type="checkbox"/> -Y/ <input checked="" type="checkbox"/> -N	Date: <u>Oct 12</u> Weather: <u>sunny</u> Scav'ged? <input type="checkbox"/> -Y/ <input checked="" type="checkbox"/> -N	Date: <u>Oct 15</u> Weather: <u>clear</u> Scav'ged? <input type="checkbox"/> -Y/ <input checked="" type="checkbox"/> -N	Date: <u>October 19</u> Weather: <u>Clear</u> Scav'ged? <input type="checkbox"/> -Y/ <input checked="" type="checkbox"/> -N		
			↳ Flag								Date:	Weather:	Scav'ged? <input type="checkbox"/> -Y/ <input type="checkbox"/> -N	Date:	Weather:	Scav'ged? <input type="checkbox"/> -Y/ <input type="checkbox"/> -N
07/10	11	4	"	"	17T	E 044 9151	N 476 3627	NE	10	2	Date: <u>Oct 8</u> Weather: <u>sunny</u> Scav'ged? <input type="checkbox"/> -Y/ <input checked="" type="checkbox"/> -N	Date: <u>Oct 12</u> Weather: <u>sunny</u> Scav'ged? <input type="checkbox"/> -Y/ <input checked="" type="checkbox"/> -N	Date: <u>Oct 15</u> Weather: <u>clear</u> Scav'ged? <input checked="" type="checkbox"/> -Y/ <input checked="" type="checkbox"/> -N	Date: <del>October 19</del> Weather: <del>Clear</del> Scav'ged? <input type="checkbox"/> -Y/ <input type="checkbox"/> -N		
			↳ red flag								Date:	Weather:	Scav'ged? <input type="checkbox"/> -Y/ <input type="checkbox"/> -N	Date:	Weather:	Scav'ged? <input type="checkbox"/> -Y/ <input type="checkbox"/> -N
07/10	7	5	"	"	17T	E 044 9644	N 476 2156	NW	20	1	Date: <u>Oct 8</u> Weather: <u>sunny</u> Scav'ged? <input type="checkbox"/> -Y/ <input checked="" type="checkbox"/> -N	Date: <u>Oct 12</u> Weather: <u>sunny</u> Scav'ged? <input type="checkbox"/> -Y/ <input type="checkbox"/> -N	Date: <del>Oct 15</del> Weather: <del>clear</del> Scav'ged? <input type="checkbox"/> -Y/ <input type="checkbox"/> -N	Date: <del>October 19</del> Weather: <del>Clear</del> Scav'ged? <input type="checkbox"/> -Y/ <input checked="" type="checkbox"/> -N		
			↳ Flag								Date:	Weather:	Scav'ged? <input type="checkbox"/> -Y/ <input type="checkbox"/> -N	Date:	Weather:	Scav'ged? <input type="checkbox"/> -Y/ <input type="checkbox"/> -N

\* See visibility class key at top of page

1 N-Not scavenged includes partial scavenging in which sufficient carcass remains for subsequent scavenging (e.g. only head removed, 1/2 or more of body remaining)

2 Y-Scavenged indicates that the carcass is entirely missing or parts remaining (e.g. feathers, wings, entrails) would not likely be further scavenged

PAGE 4 OF 4

Print Name &amp; Initial:

Ken Edwards KE

(field notes author)

Quality Control:

This form is complete  & legible 

Print Name &amp; Initial:

Amanda Bichel AB

(field notes QA/QC personnel)

Project Number: 160961010

Project Name: Adelaide Wind Farm

Date Initiated: May 4/2015

Field Personnel: Ken Edwards

Turbine No.: 6

Total Area: 7,854 m<sup>2</sup>

Total Surveyable Area: 7854 m<sup>2</sup>

% VEGETATION COVER	VEGETATION HEIGHT	VISIBILITY CLASS
≥ 90% bare ground	≤ 15cm tall	Class 1 (Easy)
≥ 25% bare ground	≤ 15cm tall	Class 2 (Moderate)
≤ 25% bare ground	≤ 25% > 30cm tall	Class 3 (Difficult)
Little or no bare ground	≥ 25% > 30cm tall	Class 4 (Very difficult)

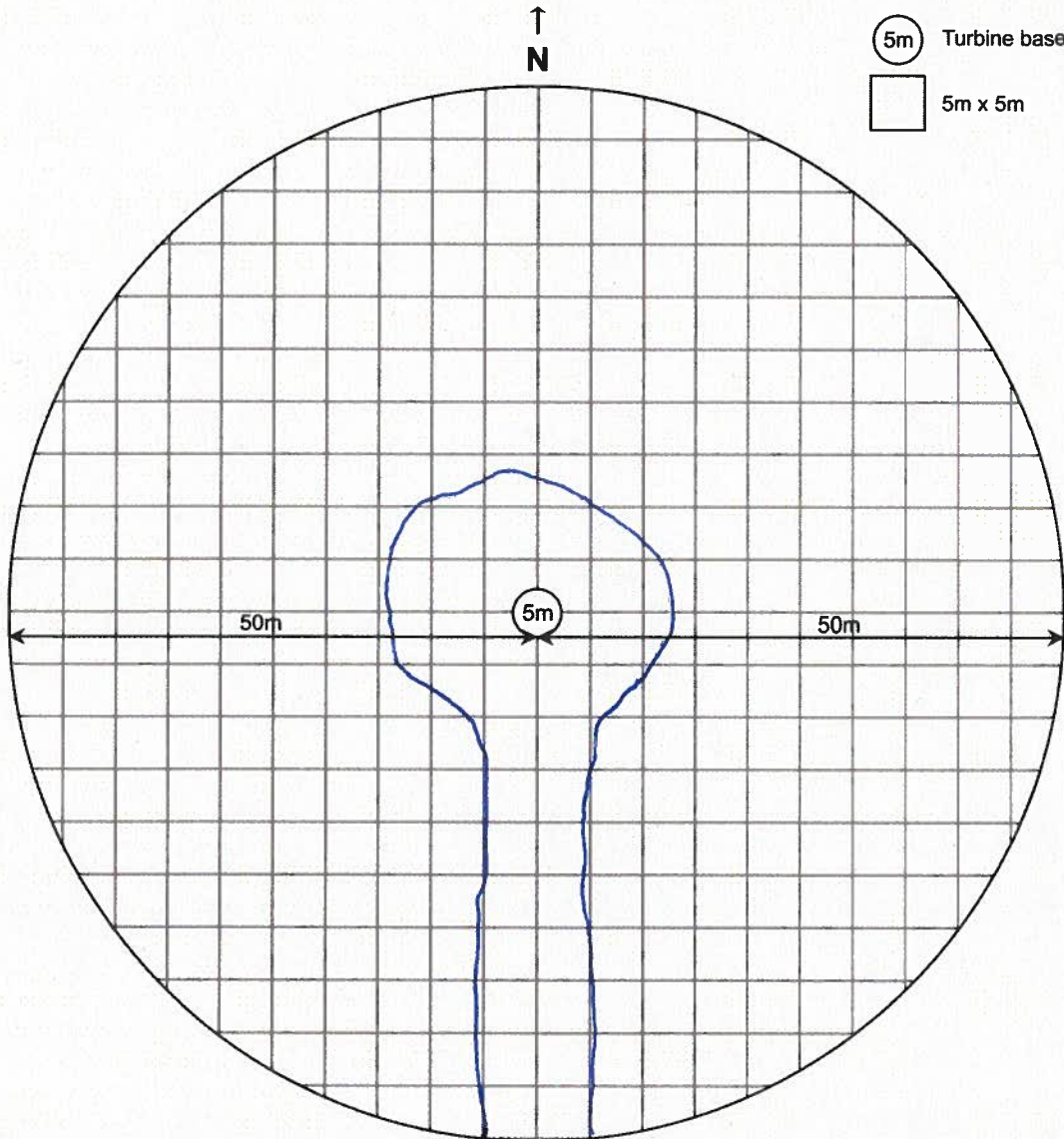

Project Number: 160961010

Project Name: Adelaide Wind Farm

Date Initiated: June 4, 2015

Field Personnel: Ken Edwards

Turbine No.: 6

Total Area: 7,854 m<sup>2</sup>

Total Surveyable Area: ~~7,854 m<sup>2</sup>~~

4347

% VEGETATION COVER	VEGETATION HEIGHT	VISIBILITY CLASS
≥ 90% bare ground	≤ 15cm tall	Class 1 (Easy)
≥ 25% bare ground	≤ 15cm tall	Class 2 (Moderate)
≤ 25% bare ground	≤ 25% > 30cm tall	Class 3 (Difficult)
Little or no bare ground	≥ 25% > 30cm tall	Class 4 (Very difficult)

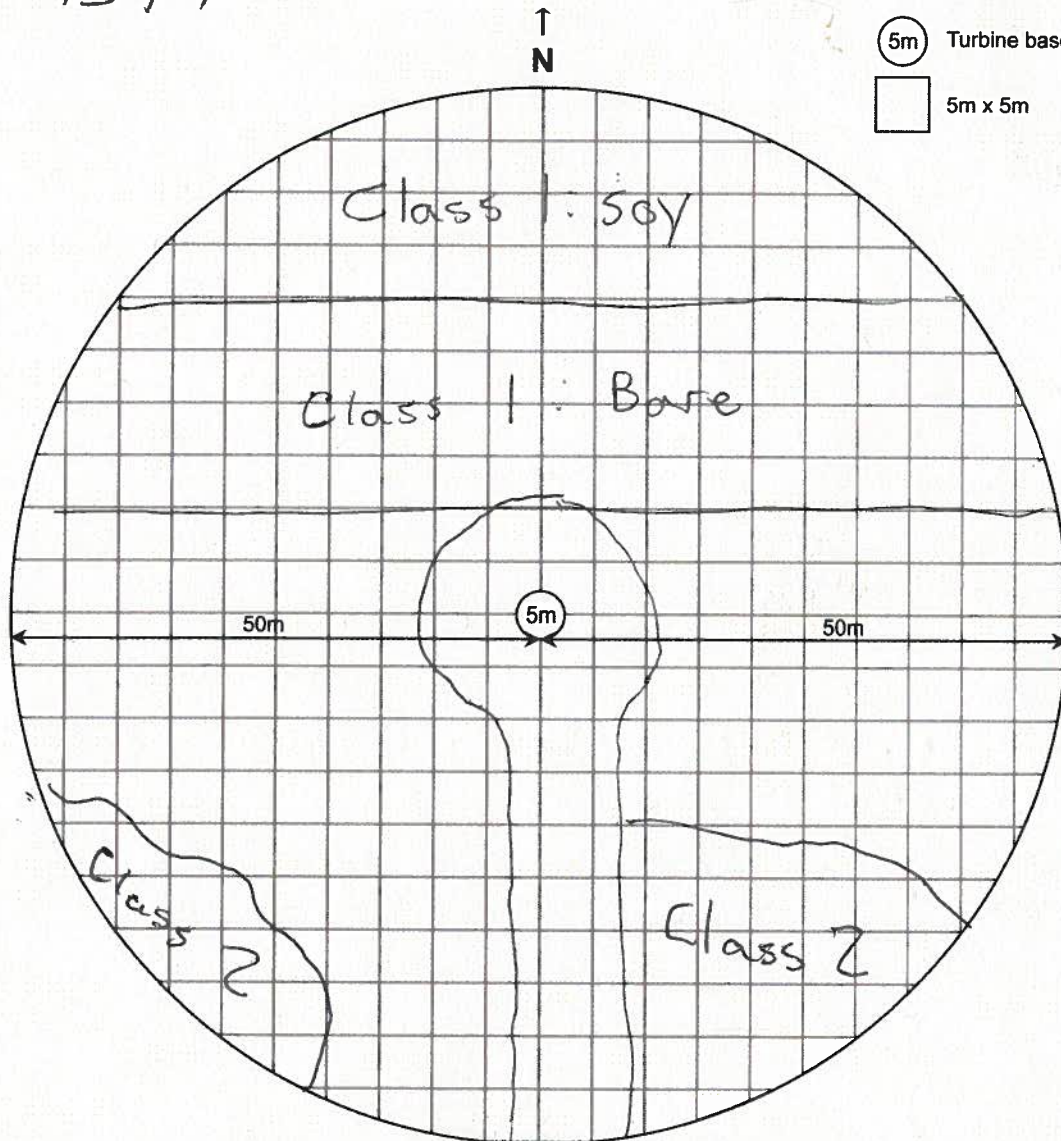

Project Number: 160961010

Project Name: Adelaide Wind Farm

Date Initiated: June 18/2015

Field Personnel: Ken Edwards

Turbine No.: 6

Total Area: 7,854 m<sup>2</sup>

Total Surveyable Area: ~~34~~ 23 m<sup>2</sup>

% VEGETATION COVER	VEGETATION HEIGHT	VISIBILITY CLASS
≥ 90% bare ground	≤ 15cm tall	Class 1 (Easy)
≥ 25% bare ground	≤ 15cm tall	Class 2 (Moderate)
≤ 25% bare ground	≤ 25% > 30cm tall	Class 3 (Difficult)
Little or no bare ground	≥ 25% > 30cm tall	Class 4 (Very difficult)

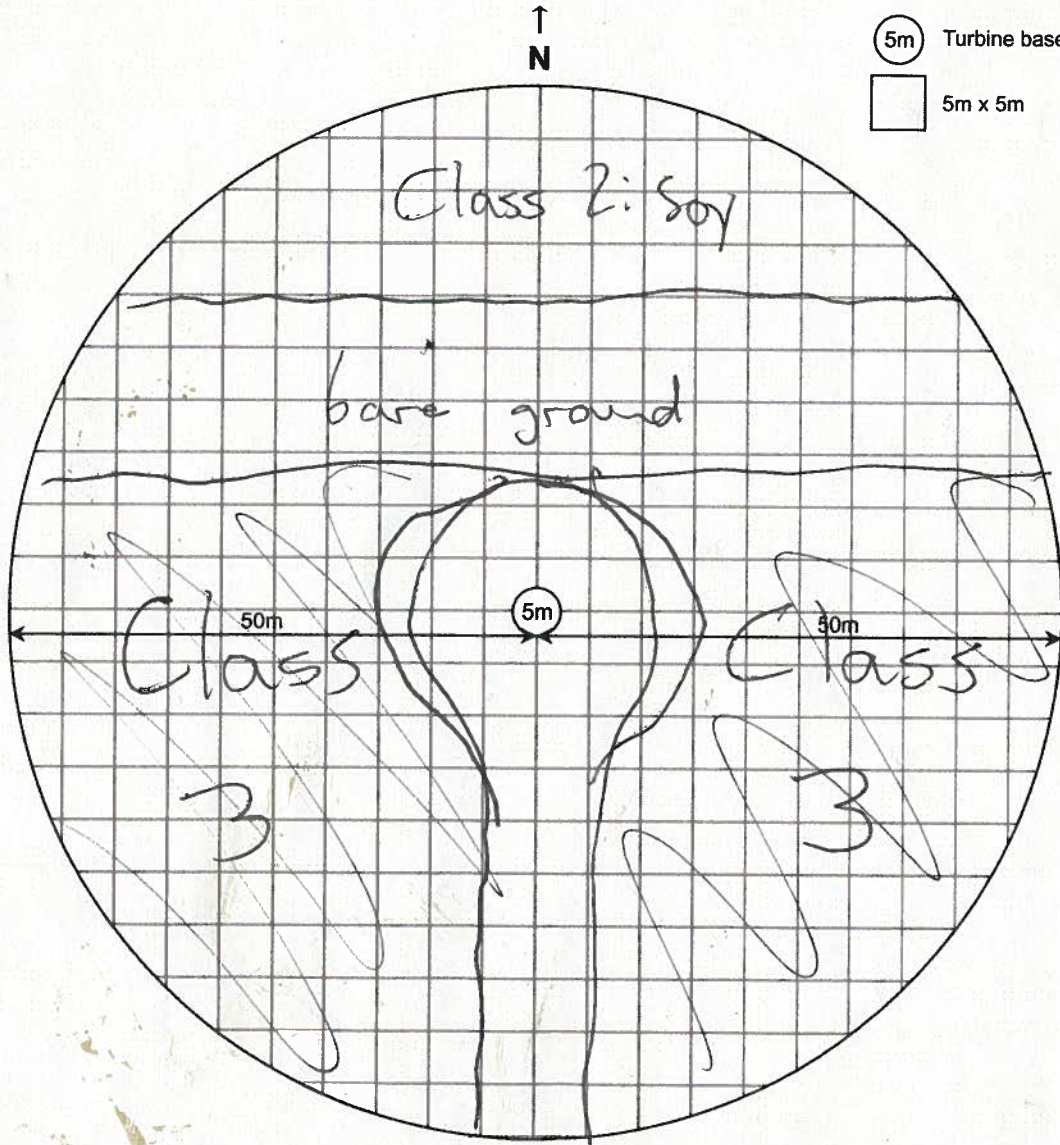



Project Number: 160961010

Project Name: Adelaide Wind Farm

Date Initiated: July 9/2015

Field Personnel: Ken Edwards

Turbine No.: 6

Total Area: 7,854 m<sup>2</sup>

Total Surveyable Area: 5368

% VEGETATION COVER	VEGETATION HEIGHT	VISIBILITY CLASS
≥ 90% bare ground	≤ 15cm tall	Class 1 (Easy)
≥ 25% bare ground	≤ 15cm tall	Class 2 (Moderate)
≤ 25% bare ground	≤ 25% > 30cm tall	Class 3 (Difficult)
Little or no bare ground	≥ 25% > 30cm tall	Class 4 (Very difficult)

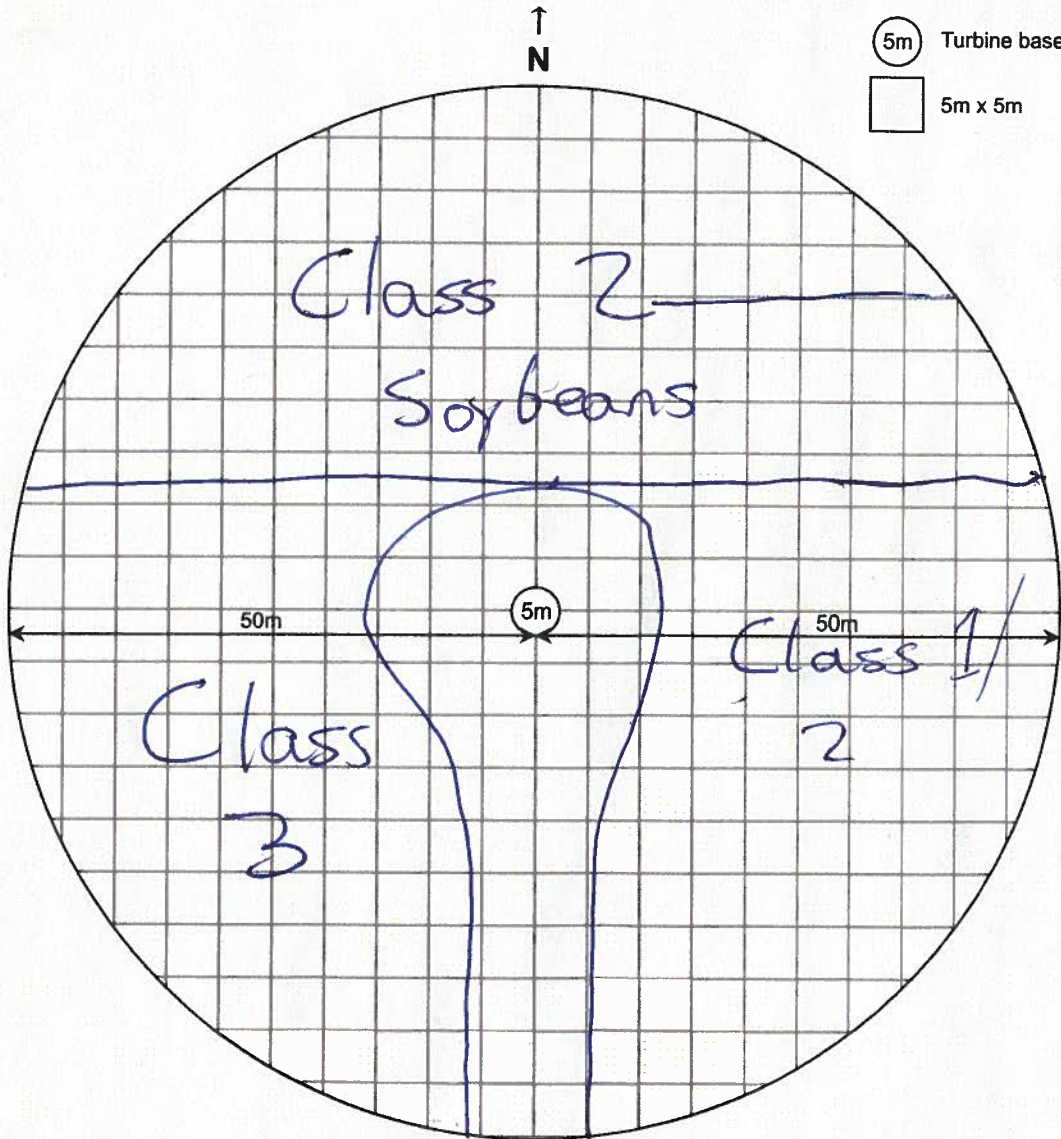

Project Number: 160961010  
Date Initiated: Sept. 14/2015

Project Name: Adelaide Wind Farm  
Field Personnel: Ken Edwards

Turbine No.: 6

Total Area: 7,854 m<sup>2</sup>

Total Surveyable Area: 2745

% VEGETATION COVER	VEGETATION HEIGHT	VISIBILITY CLASS
≥ 90% bare ground	≤ 15cm tall	Class 1 (Easy)
≥ 25% bare ground	≤ 15cm tall	Class 2 (Moderate)
≤ 25% bare ground	≤ 25% > 30cm tall	Class 3 (Difficult)
Little or no bare ground	≥ 25% > 30cm tall	Class 4 (Very difficult)

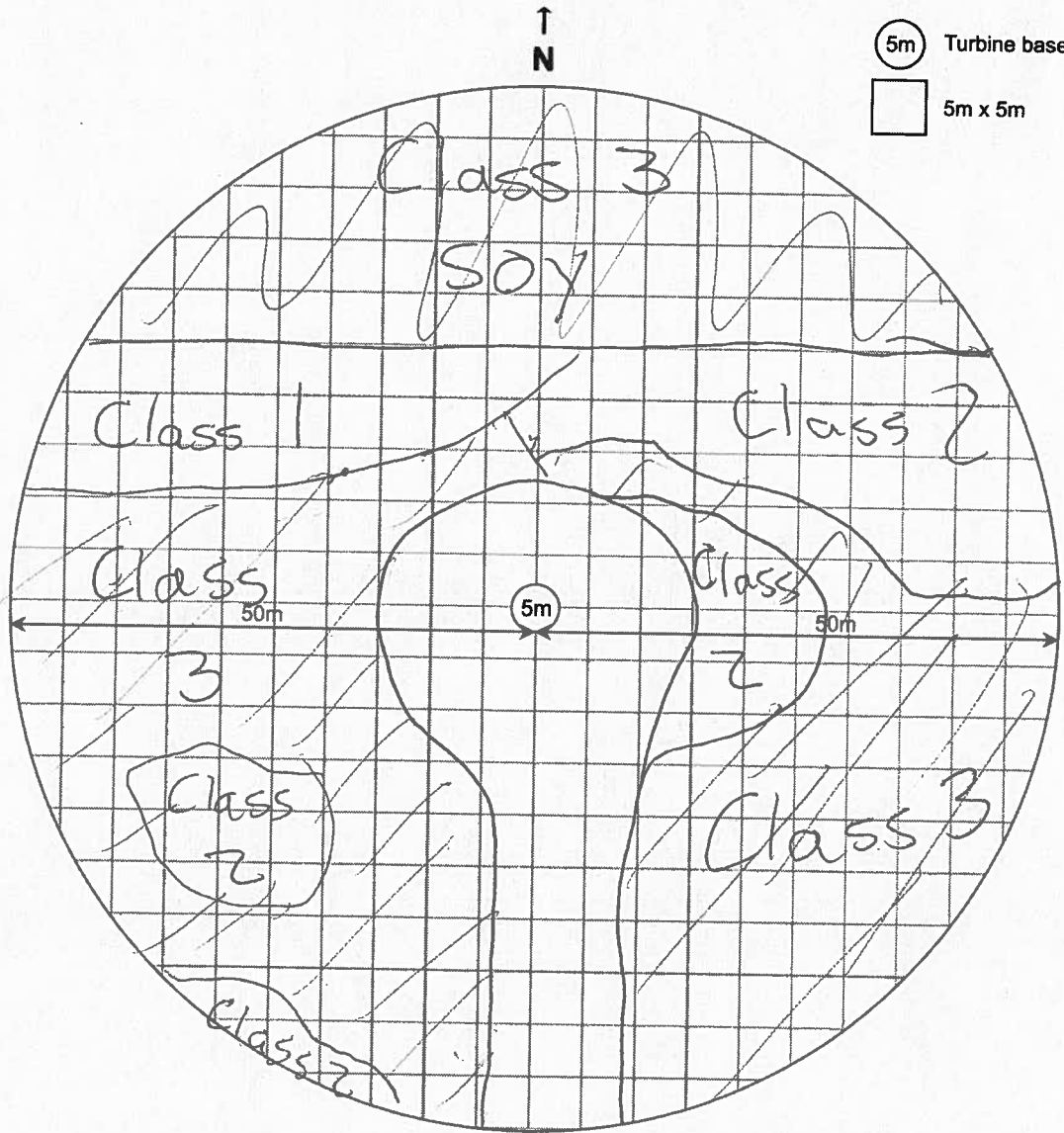

Project Number: 160961010

Project Name: Adelaide Wind Farm

Date Initiated: Oct 5

Field Personnel: Ken Edwards

Turbine No.: 6

Total Area: 7,854 m<sup>2</sup>

Total Surveyable Area: 7854

% VEGETATION COVER	VEGETATION HEIGHT	VISIBILITY CLASS
≥ 90% bare ground	≤ 15cm tall	Class 1 (Easy)
≥ 25% bare ground	≤ 15cm tall	Class 2 (Moderate)
≤ 25% bare ground	≤ 25% > 30cm tall	Class 3 (Difficult)
Little or no bare ground	≥ 25% > 30cm tall	Class 4 (Very difficult)

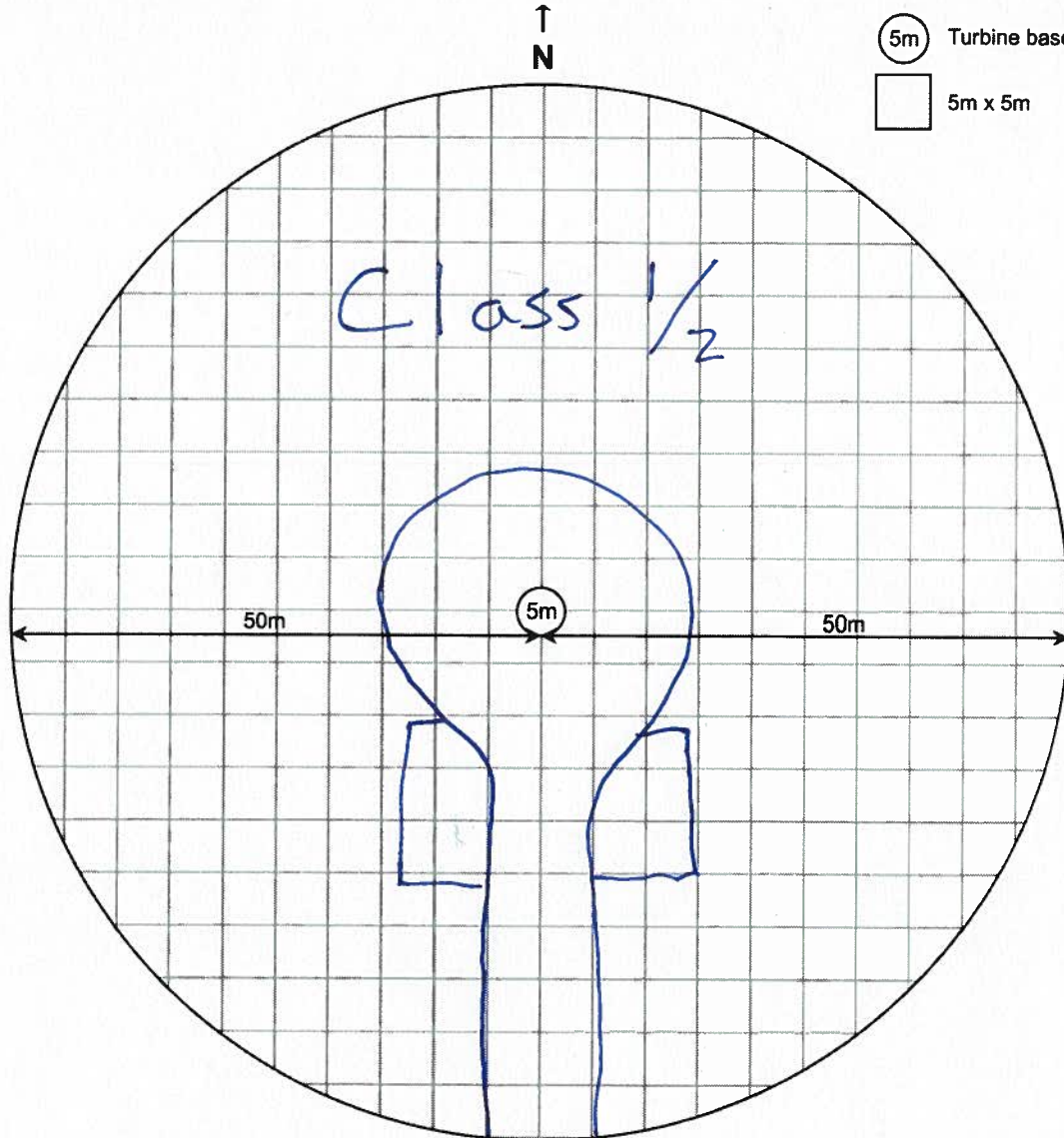

Project Number: 160961010

Project Name: Adelaide Wind Farm

Date Initiated: May 4/2015

Field Personnel: Ken Edwards

Turbine No.: 7

Total Area: 7,854 m<sup>2</sup>

Total Surveyable Area: 7,854

% VEGETATION COVER	VEGETATION HEIGHT	VISIBILITY CLASS
≥ 90% bare ground	≤ 15cm tall	Class 1 (Easy)
≥ 25% bare ground	≤ 15cm tall	Class 2 (Moderate)
≤ 25% bare ground	≤ 25% > 30cm tall	Class 3 (Difficult)
Little or no bare ground	≥ 25% > 30cm tall	Class 4 (Very difficult)

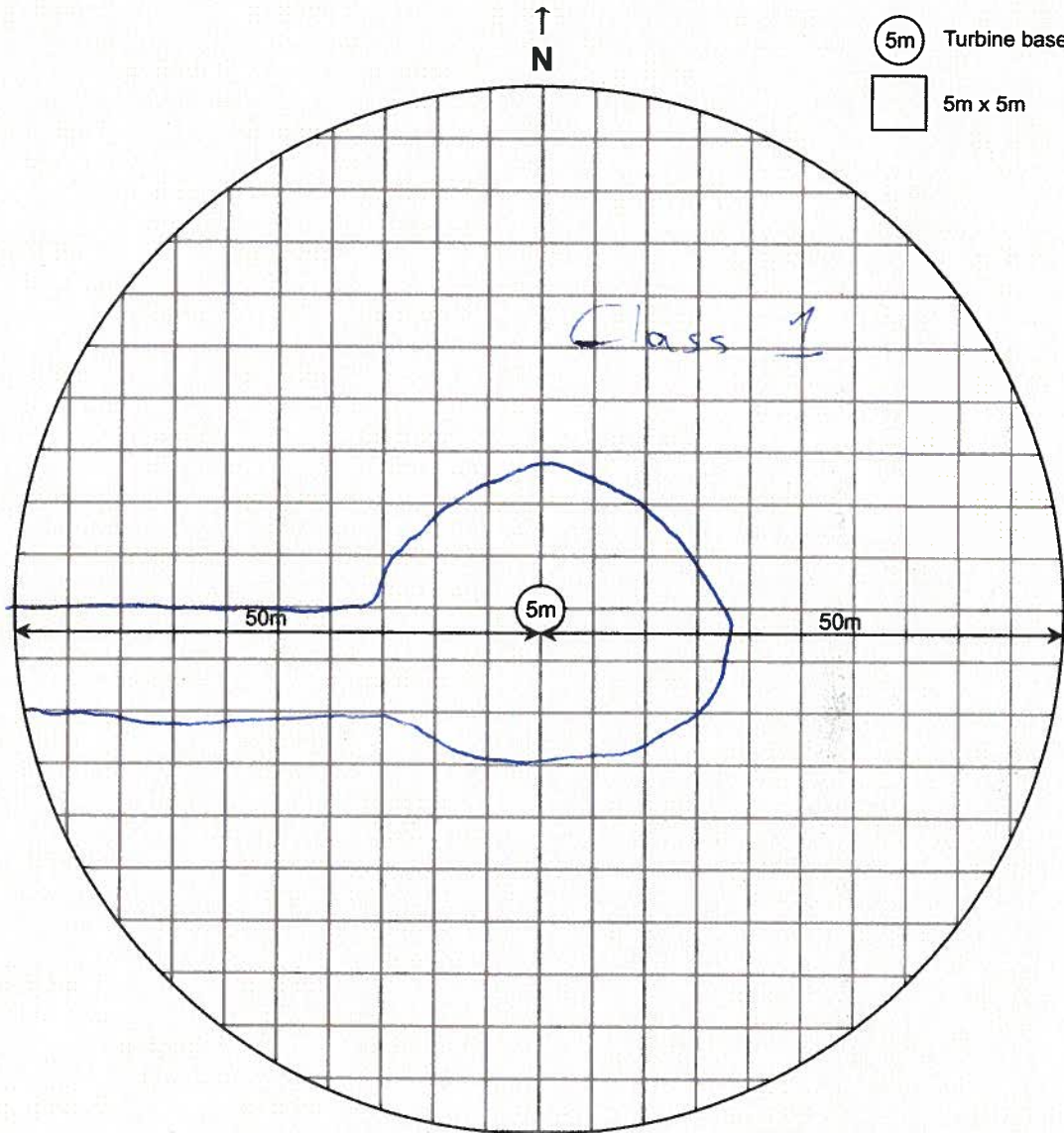

Project Number: 160961010

Project Name: Adelaide Wind Farm

Date Initiated: June 1 / 2015

Field Personnel: Ken Edwards

Turbine No.: 7

Total Area: 7,854 m<sup>2</sup>

Total Surveyable Area: 6318 m<sup>2</sup>

% VEGETATION COVER	VEGETATION HEIGHT	VISIBILITY CLASS
≥ 90% bare ground	≤ 15cm tall	Class 1 (Easy)
≥ 25% bare ground	≤ 15cm tall	Class 2 (Moderate)
≤ 25% bare ground	≤ 25% > 30cm tall	Class 3 (Difficult)
Little or no bare ground	≥ 25% > 30cm tall	Class 4 (Very difficult)

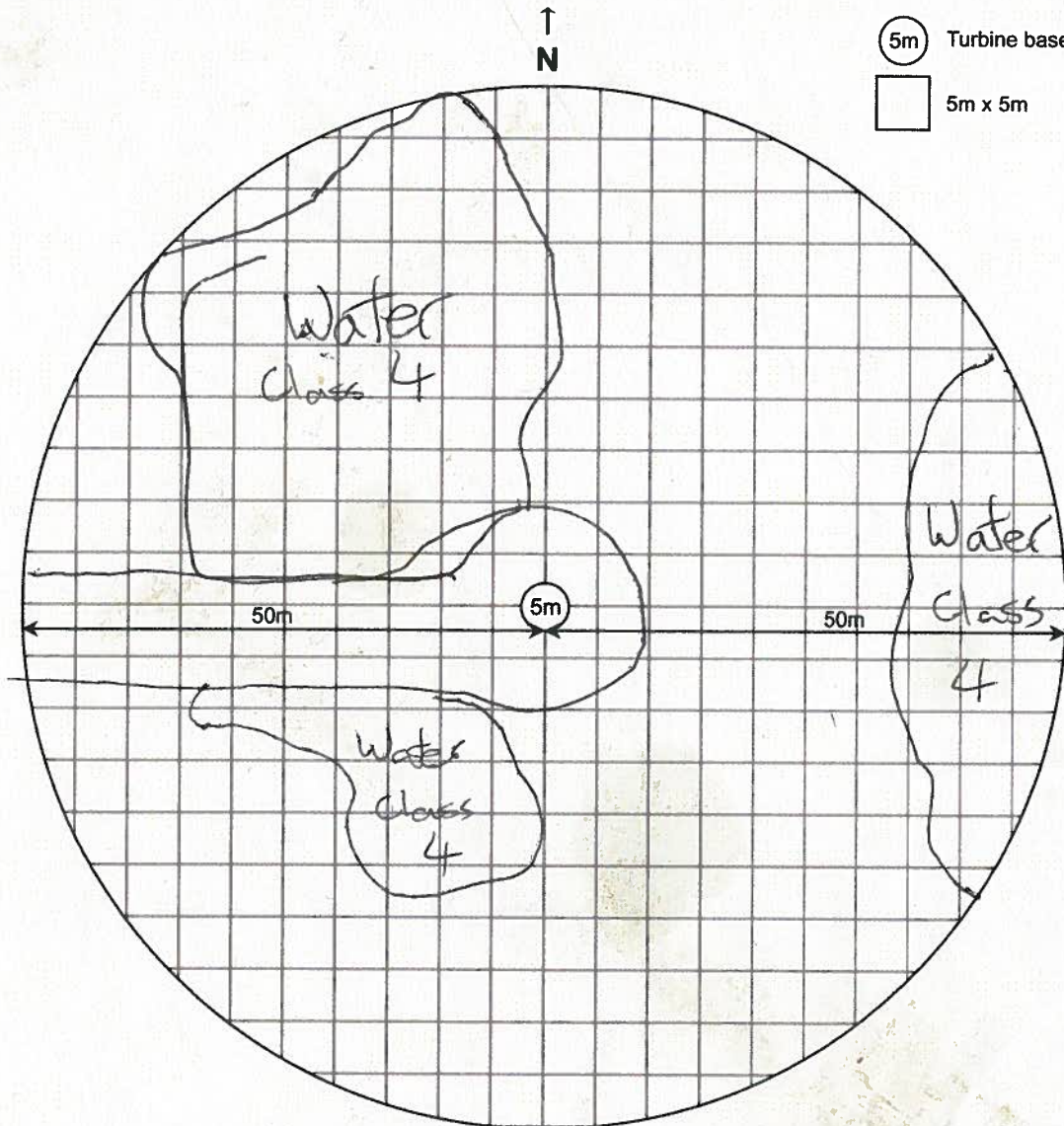

Project Number: 160961010

Project Name: Adelaide Wind Farm

Date Initiated: June 4, 2015

Field Personnel: Ken Edwards

Turbine No.: 7

Total Area: 7,854 m<sup>2</sup>

Total Surveyable Area: 6939

% VEGETATION COVER	VEGETATION HEIGHT	VISIBILITY CLASS
≥ 90% bare ground	≤ 15cm tall	Class 1 (Easy)
≥ 25% bare ground	≤ 15cm tall	Class 2 (Moderate)
≤ 25% bare ground	≤ 25% > 30cm tall	Class 3 (Difficult)
Little or no bare ground	≥ 25% > 30cm tall	Class 4 (Very difficult)

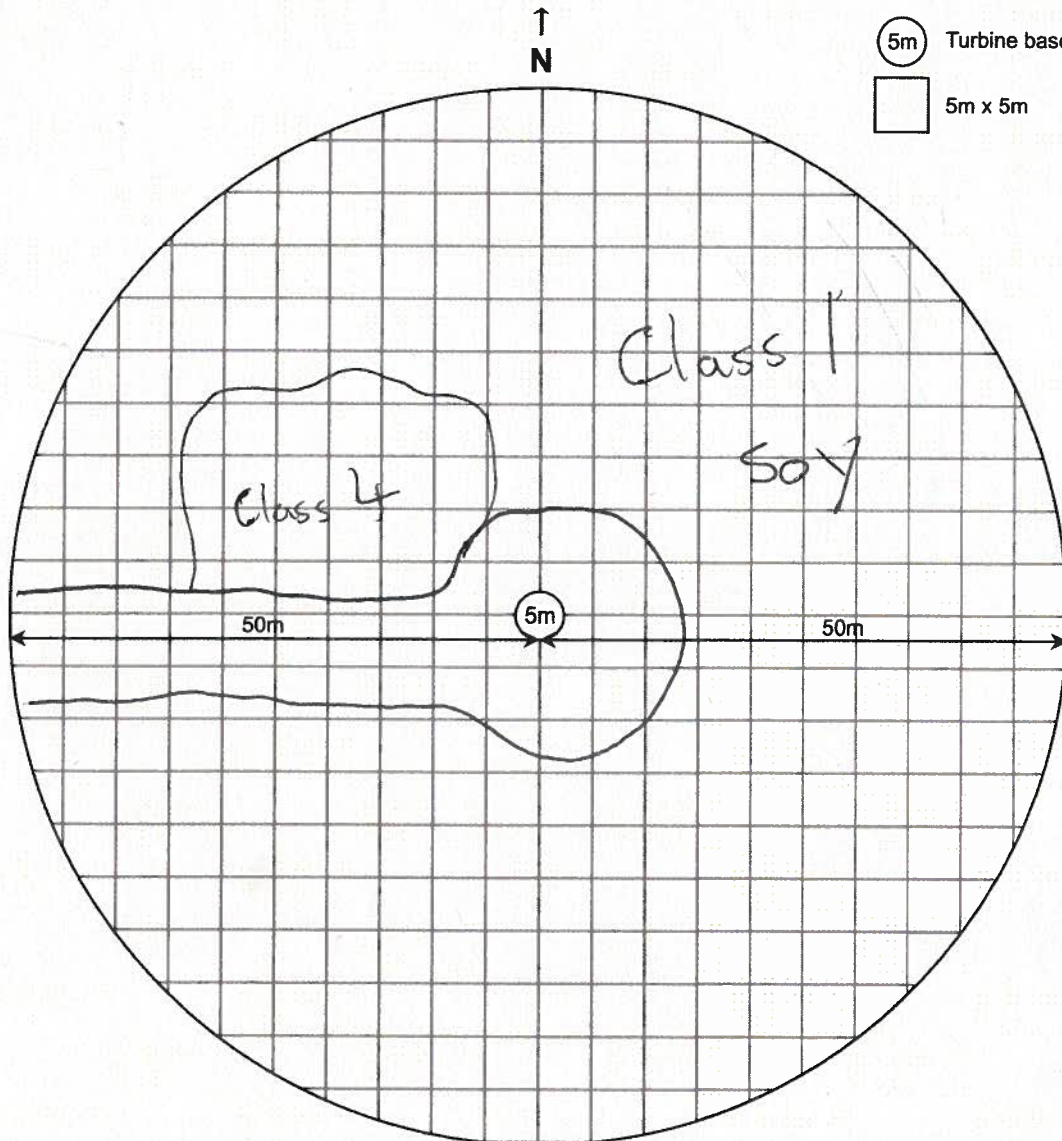

Project Number: 160961010

Project Name: Adelaide Wind Farm

Date Initiated: Oct 8 / 2015

Field Personnel: Ken Edwards

Turbine No.: 7

Total Area: 7,854 m<sup>2</sup>

Total Surveyable Area: 7173

% VEGETATION COVER	VEGETATION HEIGHT	VISIBILITY CLASS
≥ 90% bare ground	≤ 15cm tall	Class 1 (Easy)
≥ 25% bare ground	≤ 15cm tall	Class 2 (Moderate)
≤ 25% bare ground	≤ 25% > 30cm tall	Class 3 (Difficult)
Little or no bare ground	≥ 25% > 30cm tall	Class 4 (Very difficult)

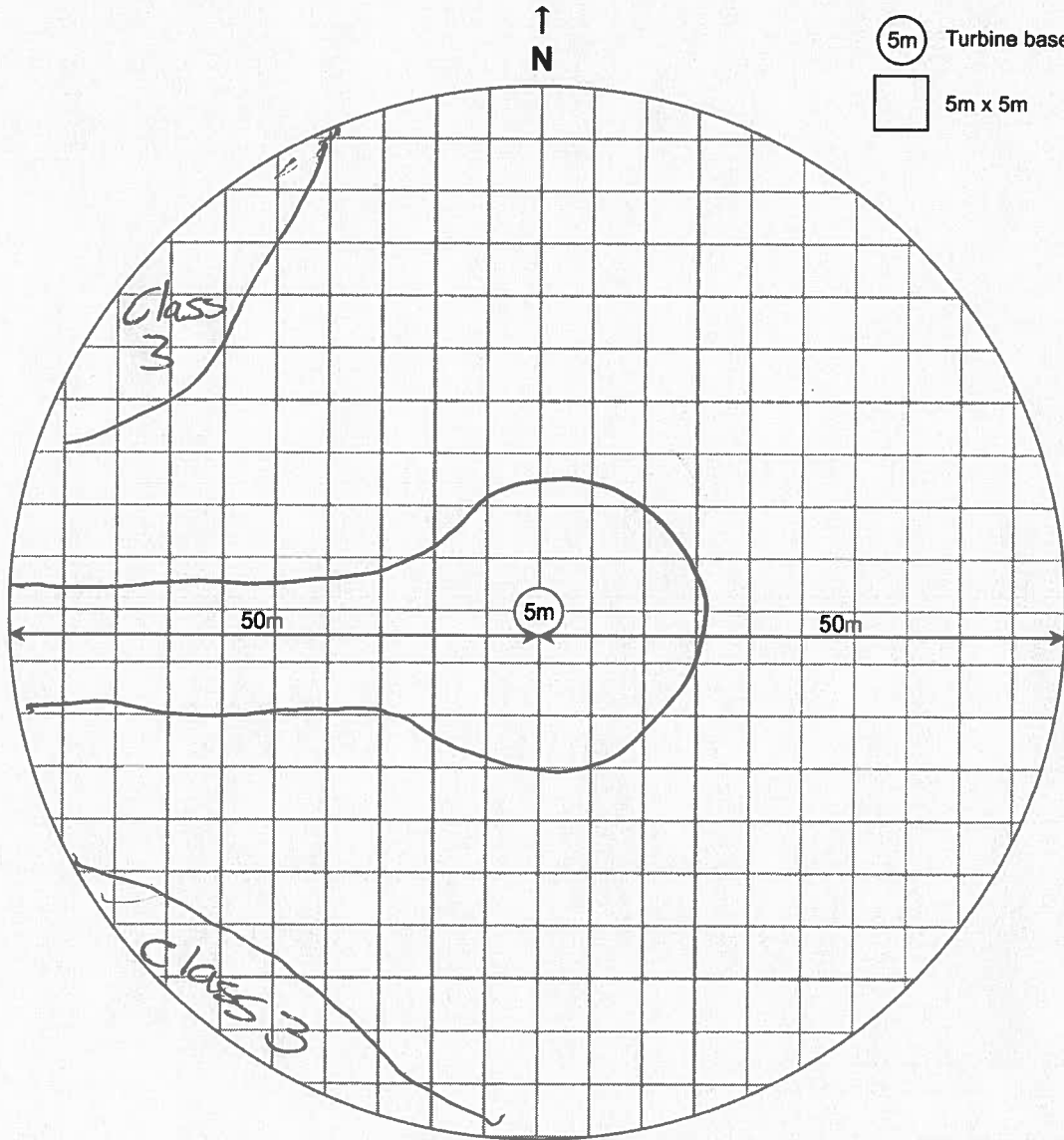

Project Number: 160961010

Project Name: Adeleide Wind Farm

Date Initiated: Oct 17/2015

Field Personnel: Ken Edwards

Turbine No.: 7

Total Area: 7,854 m<sup>2</sup>

Total Surveyable Area: 7854

% VEGETATION COVER	VEGETATION HEIGHT	VISIBILITY CLASS
≥ 90% bare ground	≤ 15cm tall	Class 1 (Easy)
≥ 25% bare ground	≤ 15cm tall	Class 2 (Moderate)
≤ 25% bare ground	≤ 25% > 30cm tall	Class 3 (Difficult)
Little or no bare ground	≥ 25% > 30cm tall	Class 4 (Very difficult)

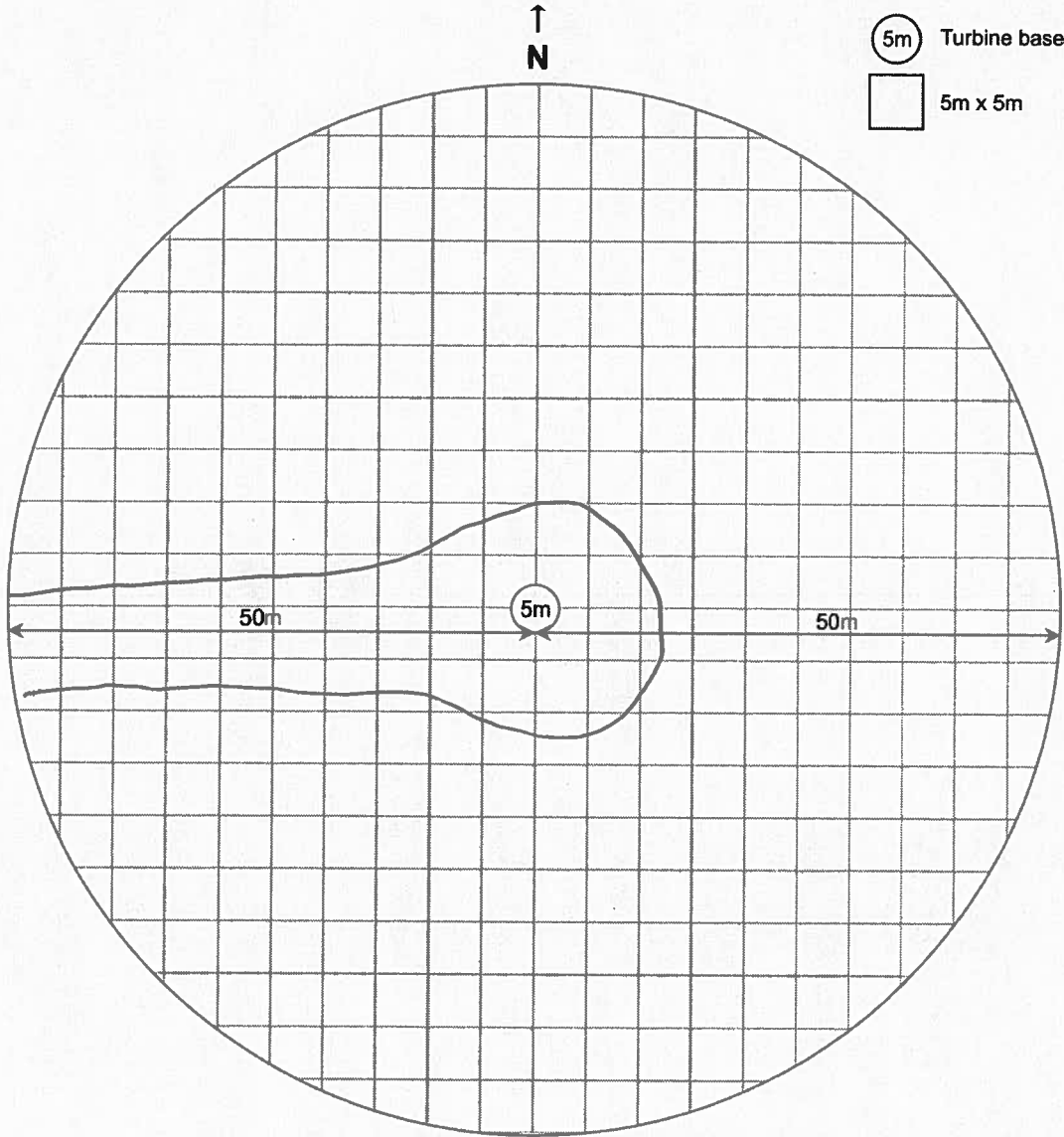



Project Number: 160961010

Project Name: Adelaide Wind Farm

Date Initiated: May 4/2015

Field Personnel: Ken Edwards

Turbine No.: 11

Total Area: 7,854 m<sup>2</sup>

Total Surveyable Area: 7854

% VEGETATION COVER	VEGETATION HEIGHT	VISIBILITY CLASS
≥ 90% bare ground	≤ 15cm tall	Class 1 (Easy)
≥ 25% bare ground	≤ 15cm tall	Class 2 (Moderate)
≤ 25% bare ground	≤ 25% > 30cm tall	Class 3 (Difficult)
Little or no bare ground	≥ 25% > 30cm tall	Class 4 (Very difficult)

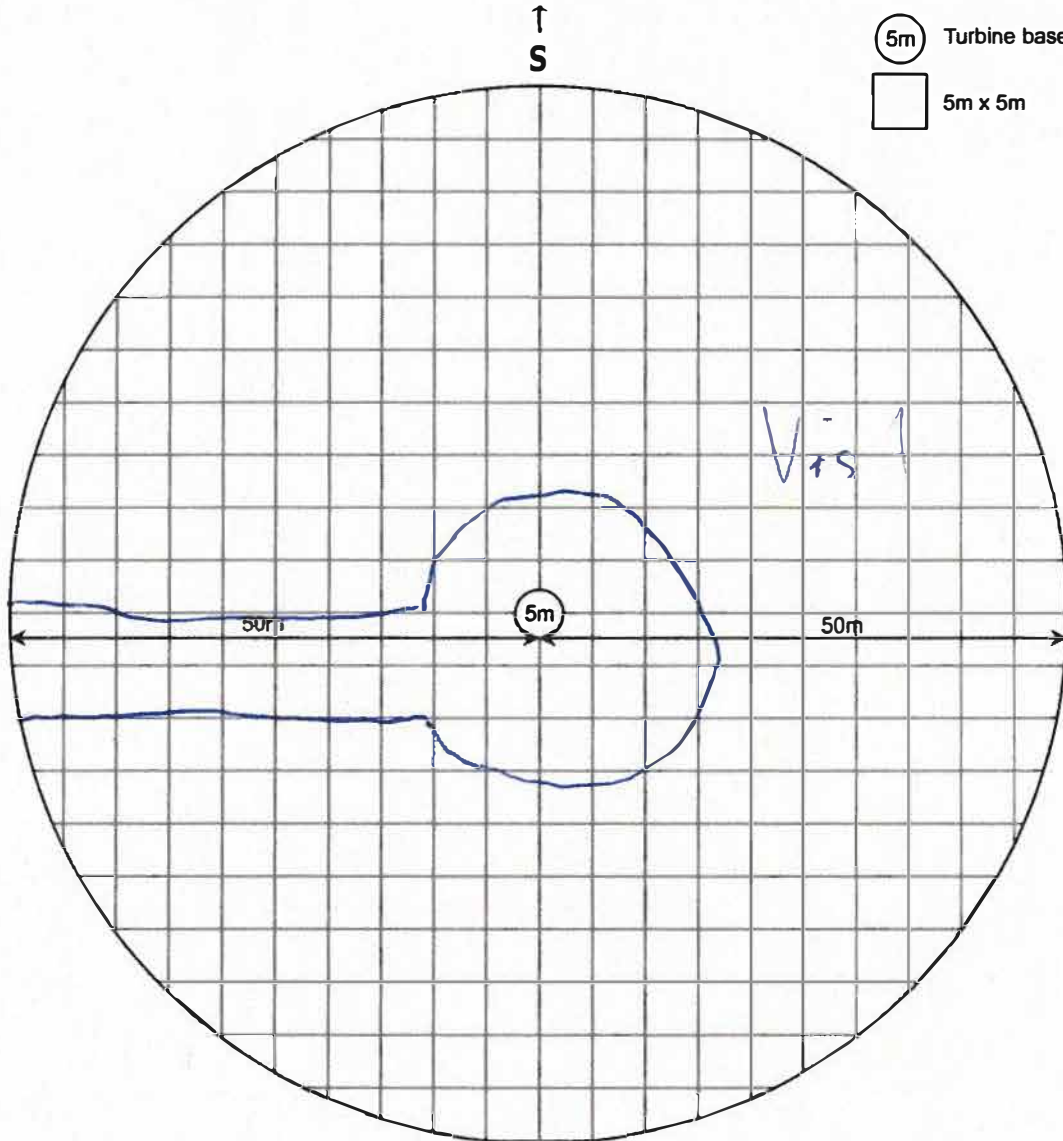

Project Number: 160961010

Project Name: Adelaide Wind Farm

Date Initiated: June 4, 2015

Field Personnel: Ken Edwards

Turbine No.: 11

Total Area: 7,854 m<sup>2</sup>

Total Surveyable Area: 7854

% VEGETATION COVER	VEGETATION HEIGHT	VISIBILITY CLASS
≥ 90% bare ground	≤ 15cm tall	Class 1 (Easy)
≥ 25% bare ground	≤ 15cm tall	Class 2 (Moderate)
≤ 25% bare ground	≤ 25% > 30cm tall	Class 3 (Difficult)
Little or no bare ground	≥ 25% > 30cm tall	Class 4 (Very difficult)

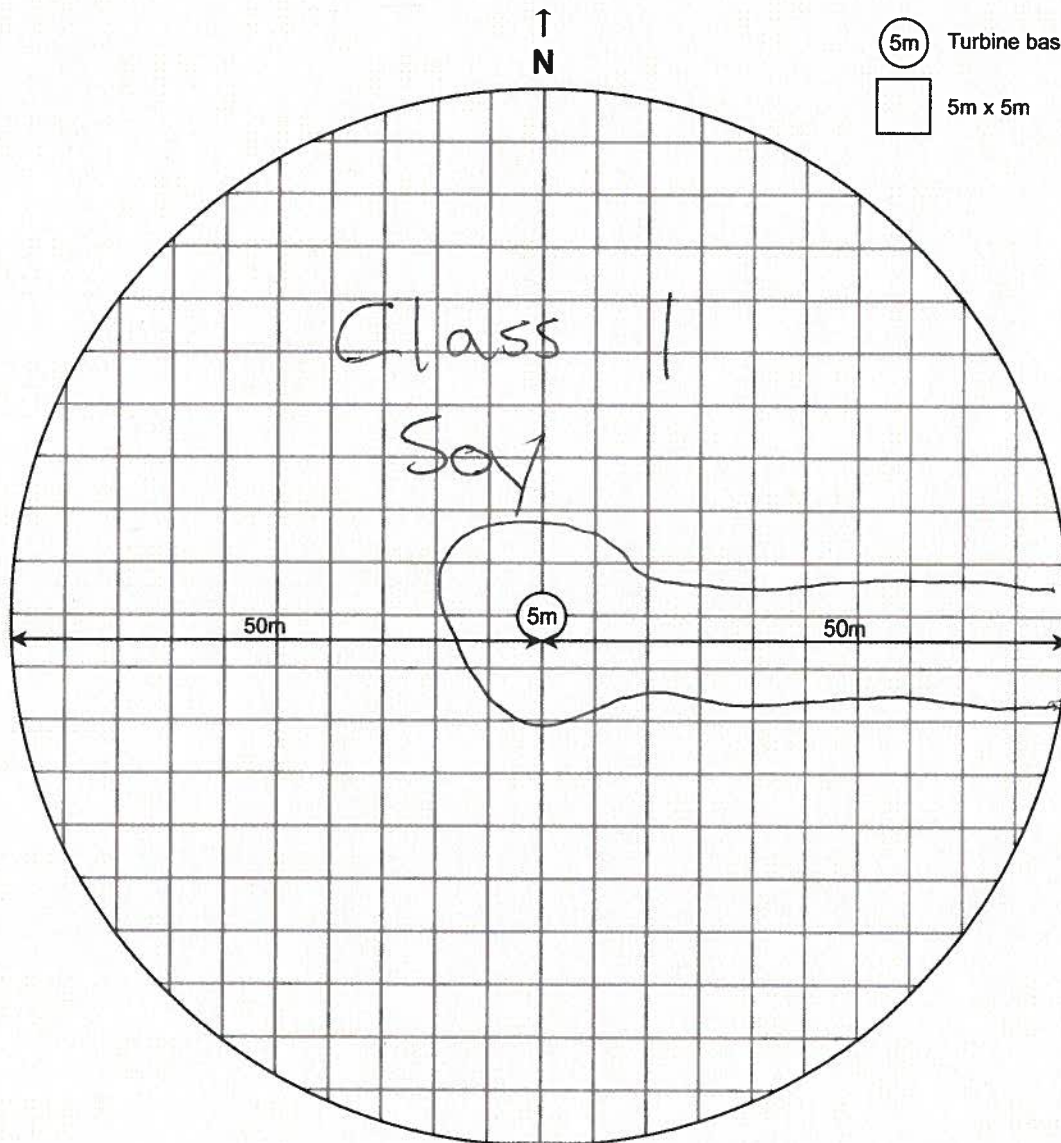

Project Number: 160961010

Project Name: Adelaide Wind Farm

Date Initiated: July 9/2015

Field Personnel: Ken Edwards

Turbine No.: 311

Total Area: 7,854 m<sup>2</sup>

Total Surveyable Area: 6978

% VEGETATION COVER	VEGETATION HEIGHT	VISIBILITY CLASS
≥ 90% bare ground	≤ 15cm tall	Class 1 (Easy)
≥ 25% bare ground	≤ 15cm tall	Class 2 (Moderate)
≤ 25% bare ground	≤ 25% > 30cm tall	Class 3 (Difficult)
Little or no bare ground	≥ 25% > 30cm tall	Class 4 (Very difficult)

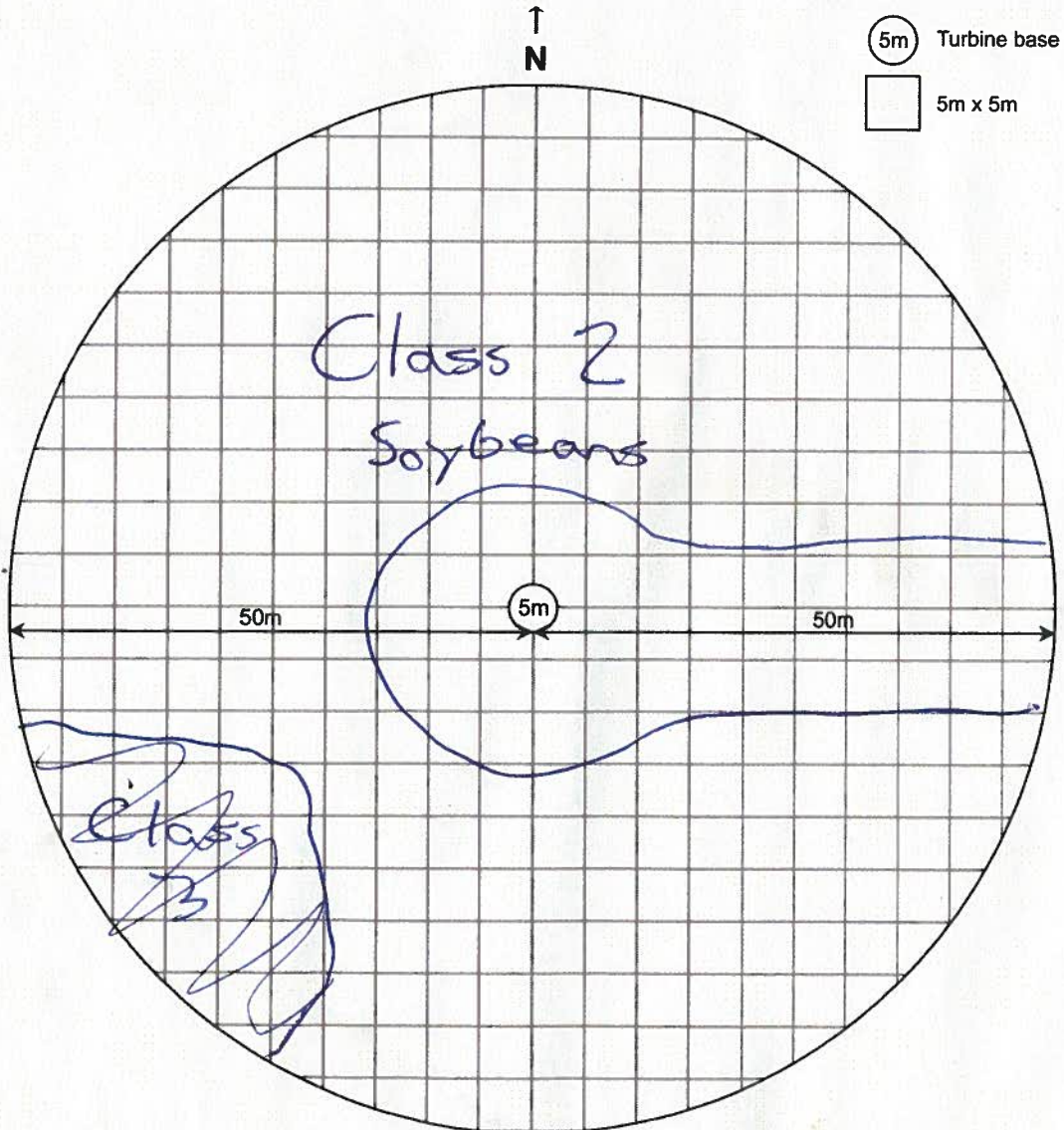

Project Number: 160961010

Project Name: Adelaide Wind Farm

Date Initiated: July 20, 2015

Field Personnel: Ken Edwards

Turbine No. 2378 II

Total Area: 7,854 m<sup>2</sup>

Total Surveyable Area: 2378

% VEGETATION COVER	VEGETATION HEIGHT	VISIBILITY CLASS
≥ 90% bare ground	≤ 15cm tall	Class 1 (Easy)
≥ 25% bare ground	≤ 15cm tall	Class 2 (Moderate)
≤ 25% bare ground	≤ 25% > 30cm tall	Class 3 (Difficult)
Little or no bare ground	≥ 25% > 30cm tall	Class 4 (Very difficult)

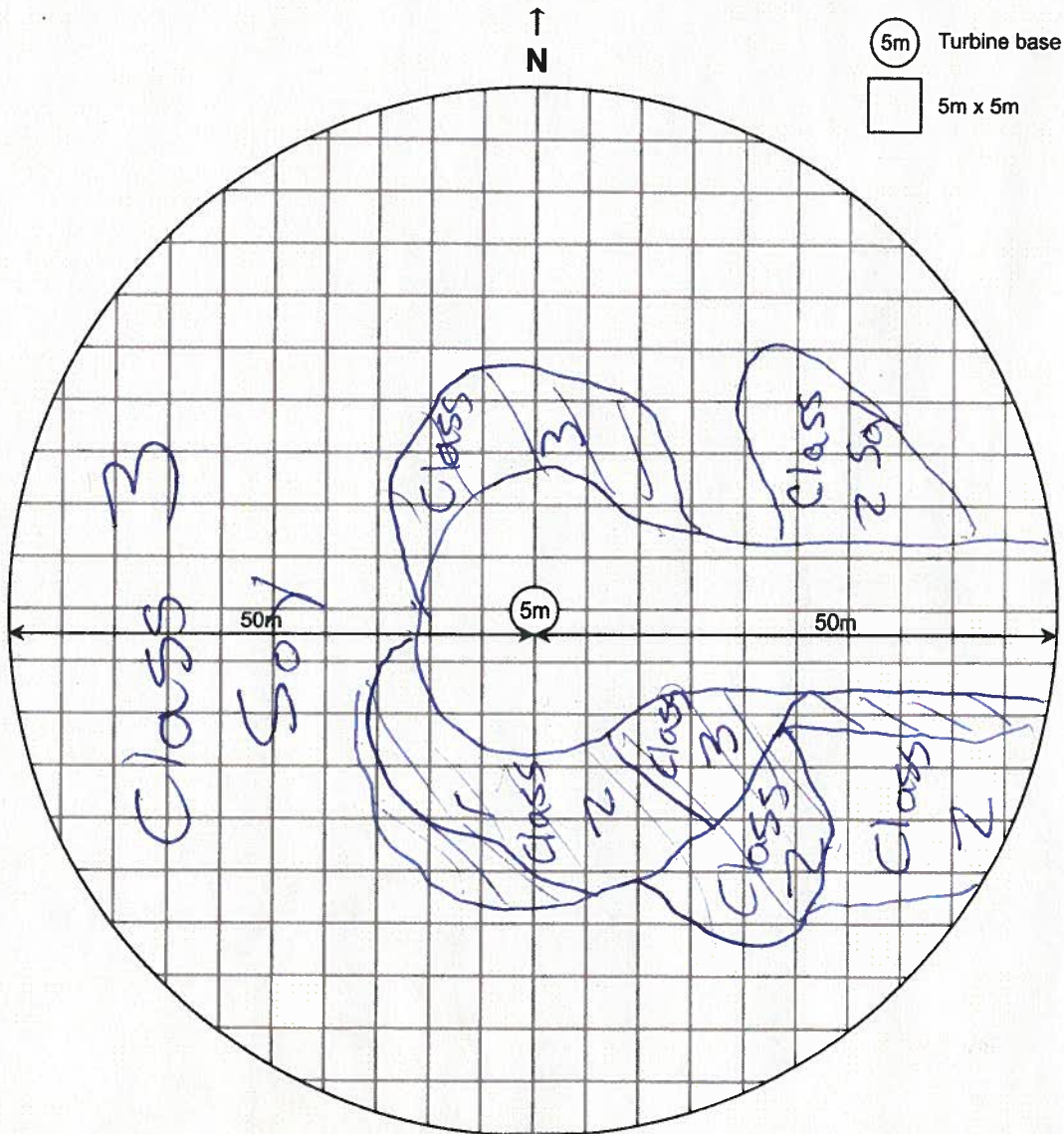

Project Number: 160961010  
Date Initiated: Oct 5/2015

Project Name: Adelaide Wind Farm  
Field Personnel: Ken Edwards

Turbine No.: 11

Total Area: 7,854 m<sup>2</sup>

Total Surveyable Area: 7854

% VEGETATION COVER	VEGETATION HEIGHT	VISIBILITY CLASS
≥ 90% bare ground	≤ 15cm tall	Class 1 (Easy)
≥ 25% bare ground	≤ 15cm tall	Class 2 (Moderate)
≤ 25% bare ground	≤ 25% > 30cm tall	Class 3 (Difficult)
Little or no bare ground	≥ 25% > 30cm tall	Class 4 (Very difficult)

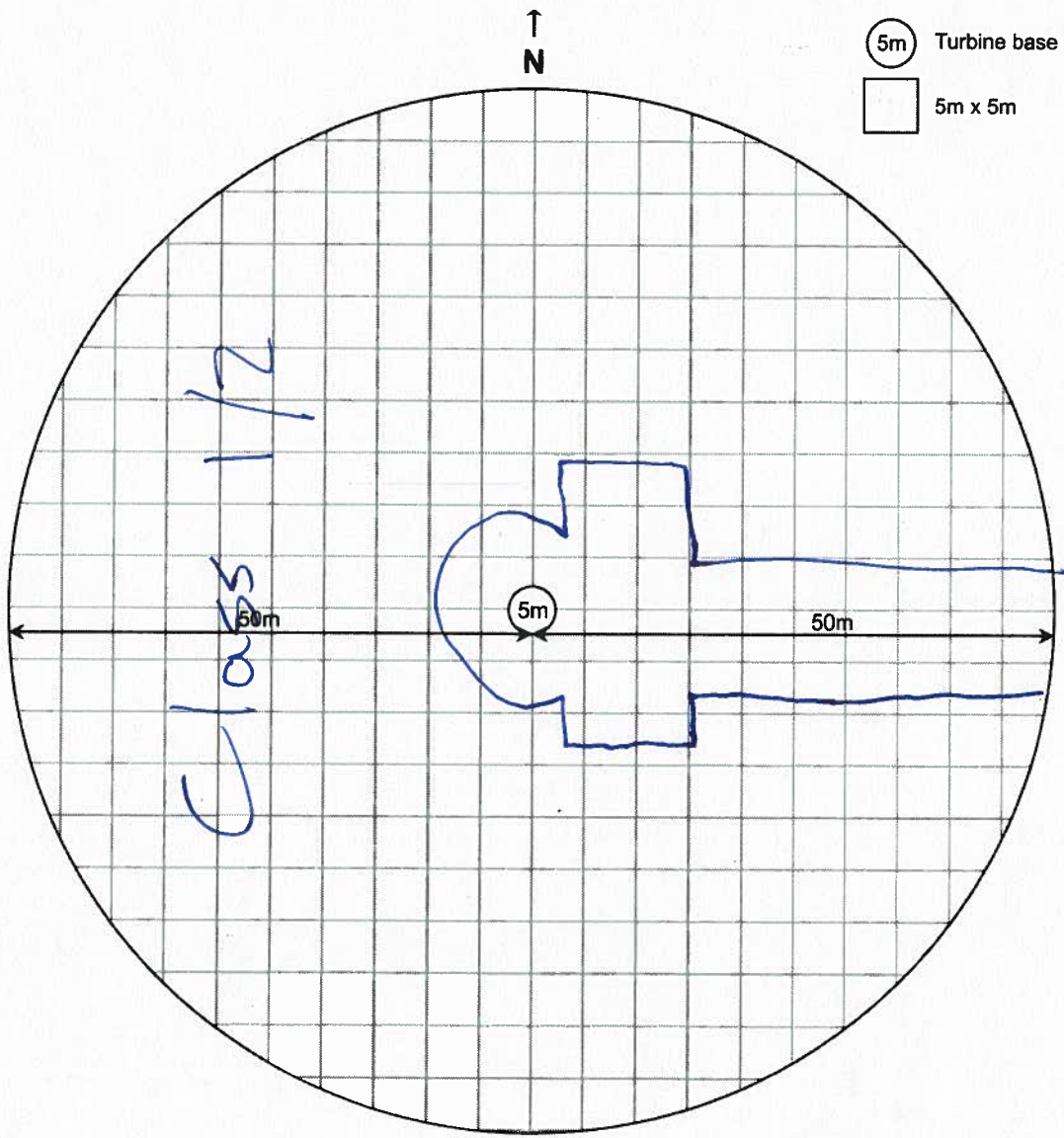

5m Turbine base  
5m x 5m

Project Number: 160961010

Project Name: Adelaide Wind Farm

Date Initiated: May 4 / 2015

Field Personnel: Ken Edwards

Turbine No.: 12

Total Area: 7,854 m<sup>2</sup>

Total Surveyable Area: 7854

% VEGETATION COVER	VEGETATION HEIGHT	VISIBILITY CLASS
≥ 90% bare ground	≤ 15cm tall	Class 1 (Easy)
≥ 25% bare ground	≤ 15cm tall	Class 2 (Moderate)
≤ 25% bare ground	≤ 25% > 30cm tall	Class 3 (Difficult)
Little or no bare ground	≥ 25% > 30cm tall	Class 4 (Very difficult)

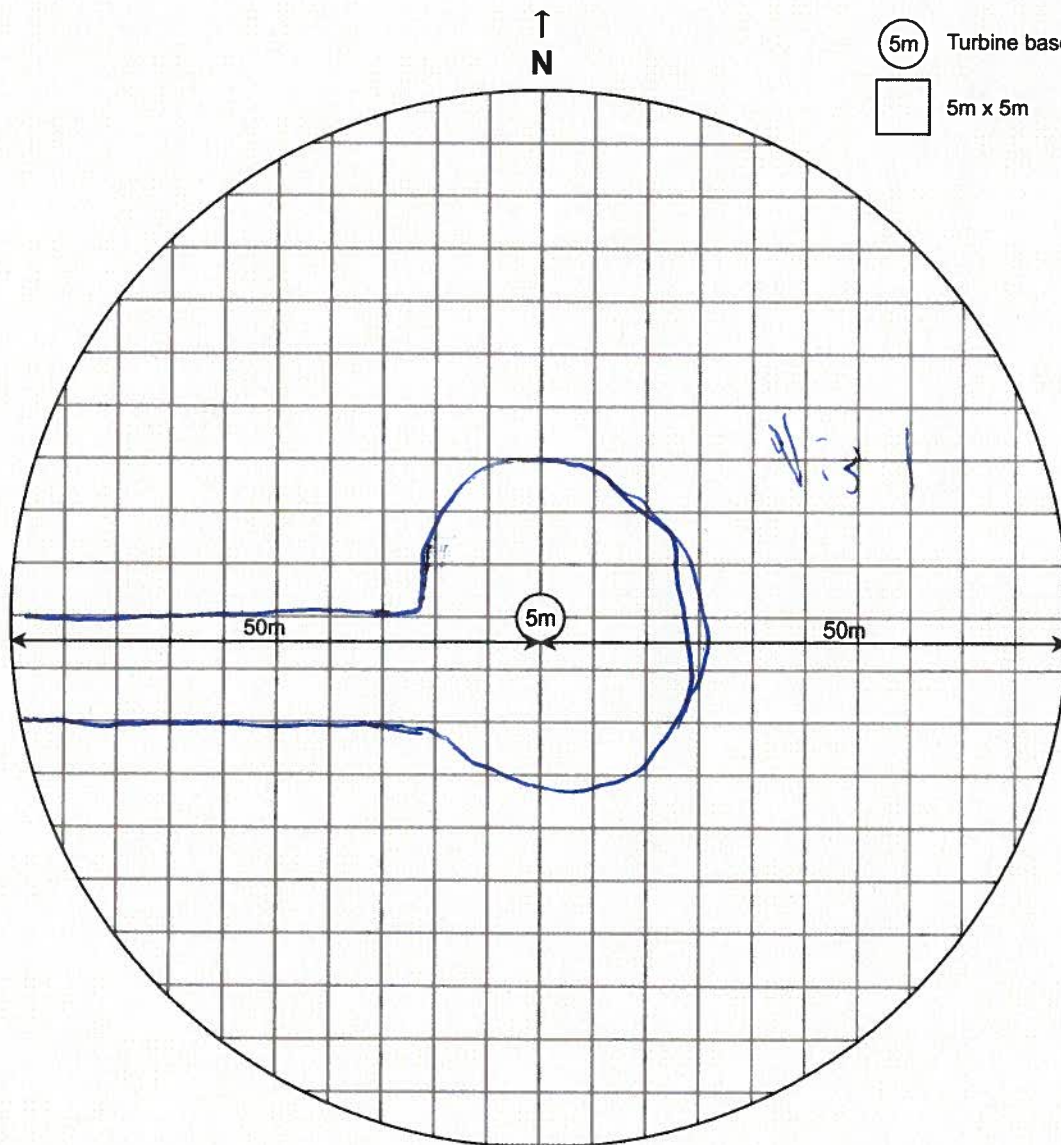

Project Number: 160961010

Project Name: Adelaide Wind Farm

Date Initiated: June 4 2015

Field Personnel: Ken Edwards

Turbine No.: 12

Total Area: 7,854 m<sup>2</sup>

Total Surveyable Area: 7854

% VEGETATION COVER	VEGETATION HEIGHT	VISIBILITY CLASS
≥ 90% bare ground	≤ 15cm tall	Class 1 (Easy)
≥ 25% bare ground	≤ 15cm tall	Class 2 (Moderate)
≤ 25% bare ground	≤ 25% > 30cm tall	Class 3 (Difficult)
Little or no bare ground	≥ 25% > 30cm tall	Class 4 (Very difficult)

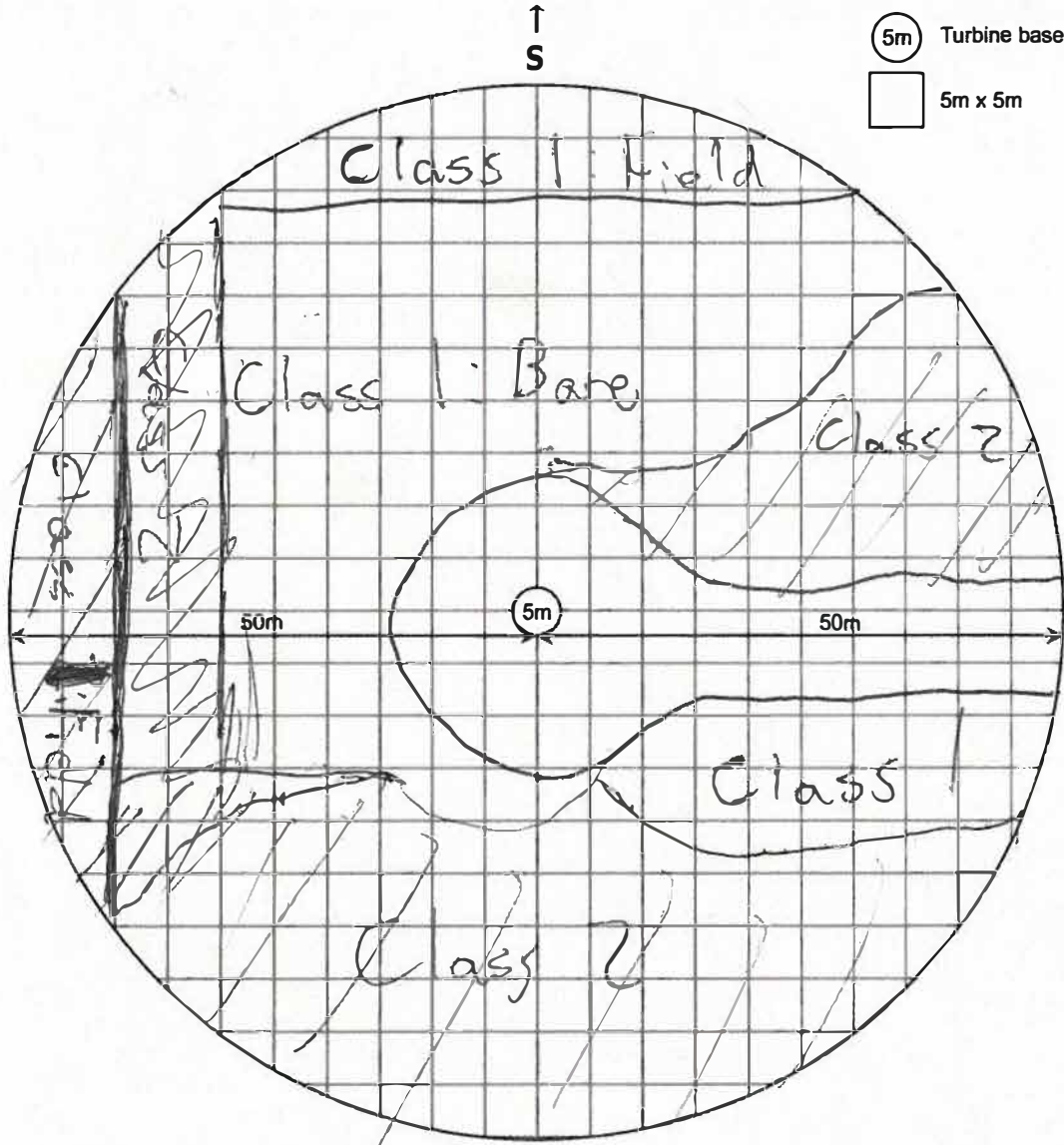

Project Number: 160961010

Project Name: Adelaide Wind Farm

Date Initiated: July 13, 2015

Field Personnel: Ken Edwards

Turbine No.: 12

Total Area: 7,854 m<sup>2</sup>

Total Surveyable Area: 2928

% VEGETATION COVER	VEGETATION HEIGHT	VISIBILITY CLASS
≥ 90% bare ground	≤ 15cm tall	Class 1 (Easy)
≥ 25% bare ground	≤ 15cm tall	Class 2 (Moderate)
≤ 25% bare ground	≤ 25% > 30cm tall	Class 3 (Difficult)
Little or no bare ground	≥ 25% > 30cm tall	Class 4 (Very difficult)

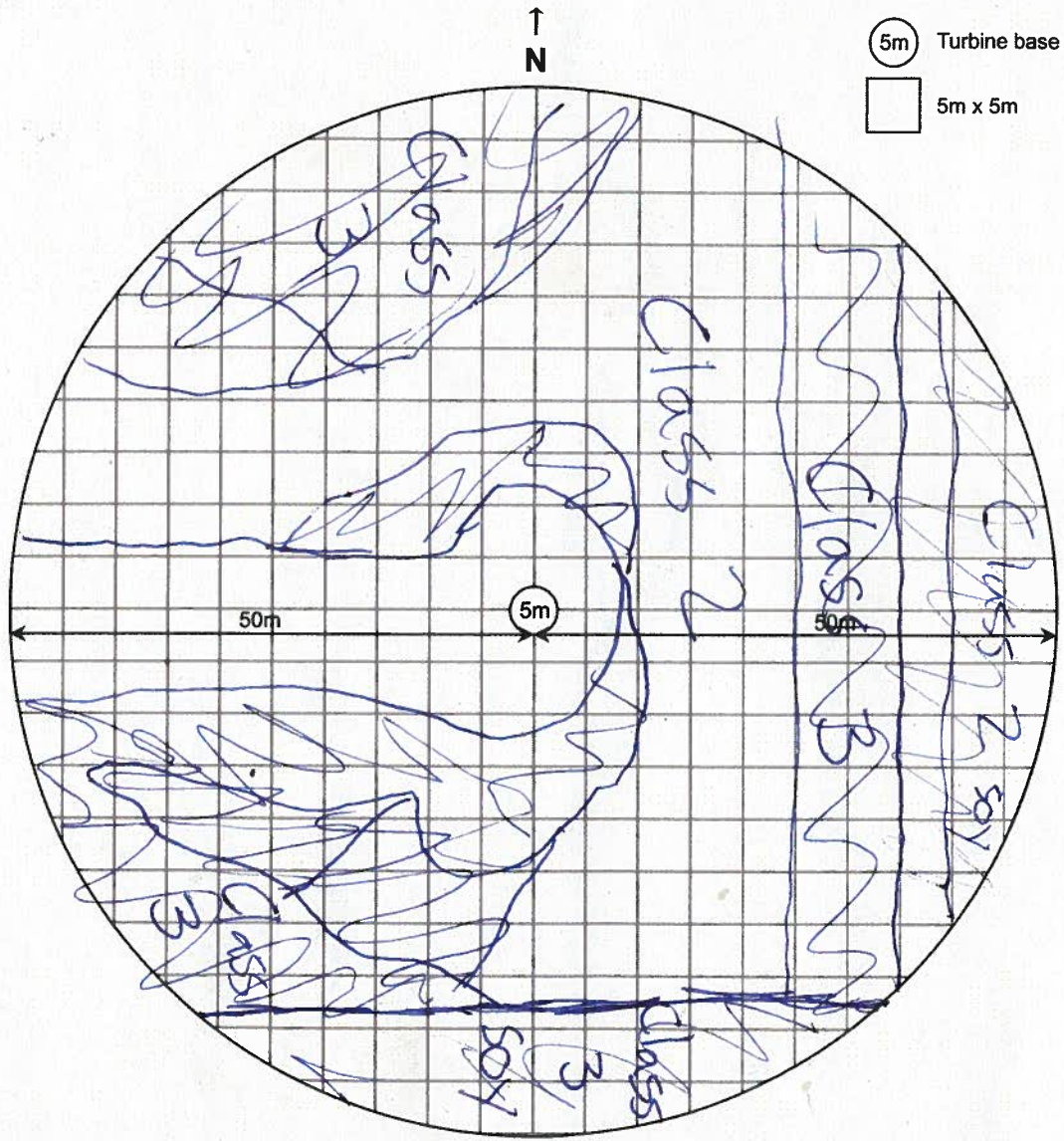



Project Number: 160961010

Project Name: Adelaide Wind Farm

Date Initiated: June 18 / 2015

Field Personnel: Ken Edwards

Turbine No.: 12

Total Area: 7,854 m<sup>2</sup>

Total Surveyable Area: 6821

% VEGETATION COVER	VEGETATION HEIGHT	VISIBILITY CLASS
≥ 90% bare ground	≤ 15cm tall	Class 1 (Easy)
≥ 25% bare ground	≤ 15cm tall	Class 2 (Moderate)
≤ 25% bare ground	≤ 25% > 30cm tall	Class 3 (Difficult)
Little or no bare ground	≥ 25% > 30cm tall	Class 4 (Very difficult)

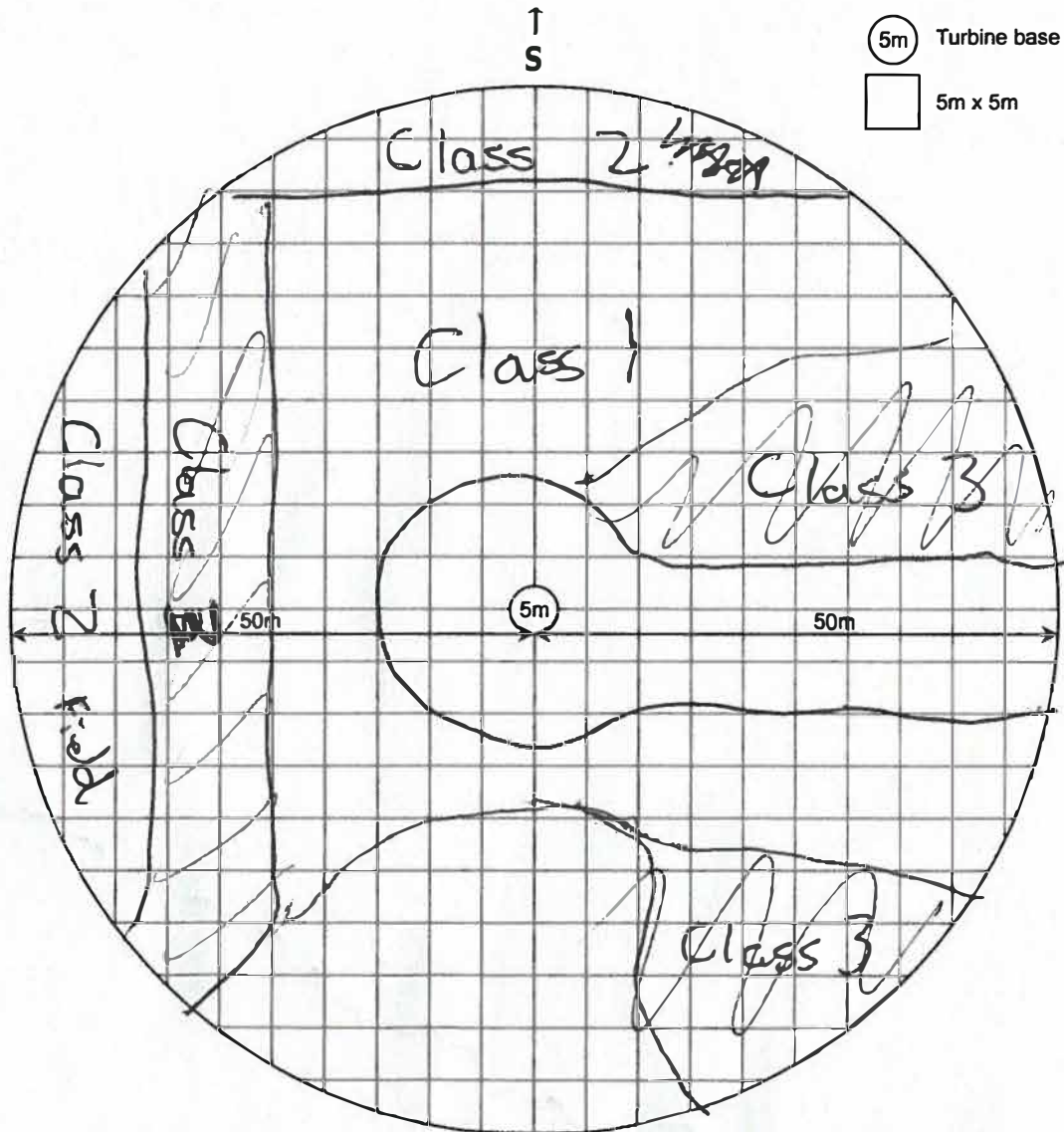

Project Number: 160961010

Project Name: Adelaide Wind Farm

Date Initiated: July 16/2015

Field Personnel: Ken Edwards

Turbine No.: 12

Total Area: 7,854 m<sup>2</sup>

Total Surveyable Area: 2438

% VEGETATION COVER	VEGETATION HEIGHT	VISIBILITY CLASS
≥ 90% bare ground	≤ 15cm tall	Class 1 (Easy)
≥ 25% bare ground	≤ 15cm tall	Class 2 (Moderate)
≤ 25% bare ground	≤ 25% > 30cm tall	Class 3 (Difficult)
Little or no bare ground	≥ 25% > 30cm tall	Class 4 (Very difficult)

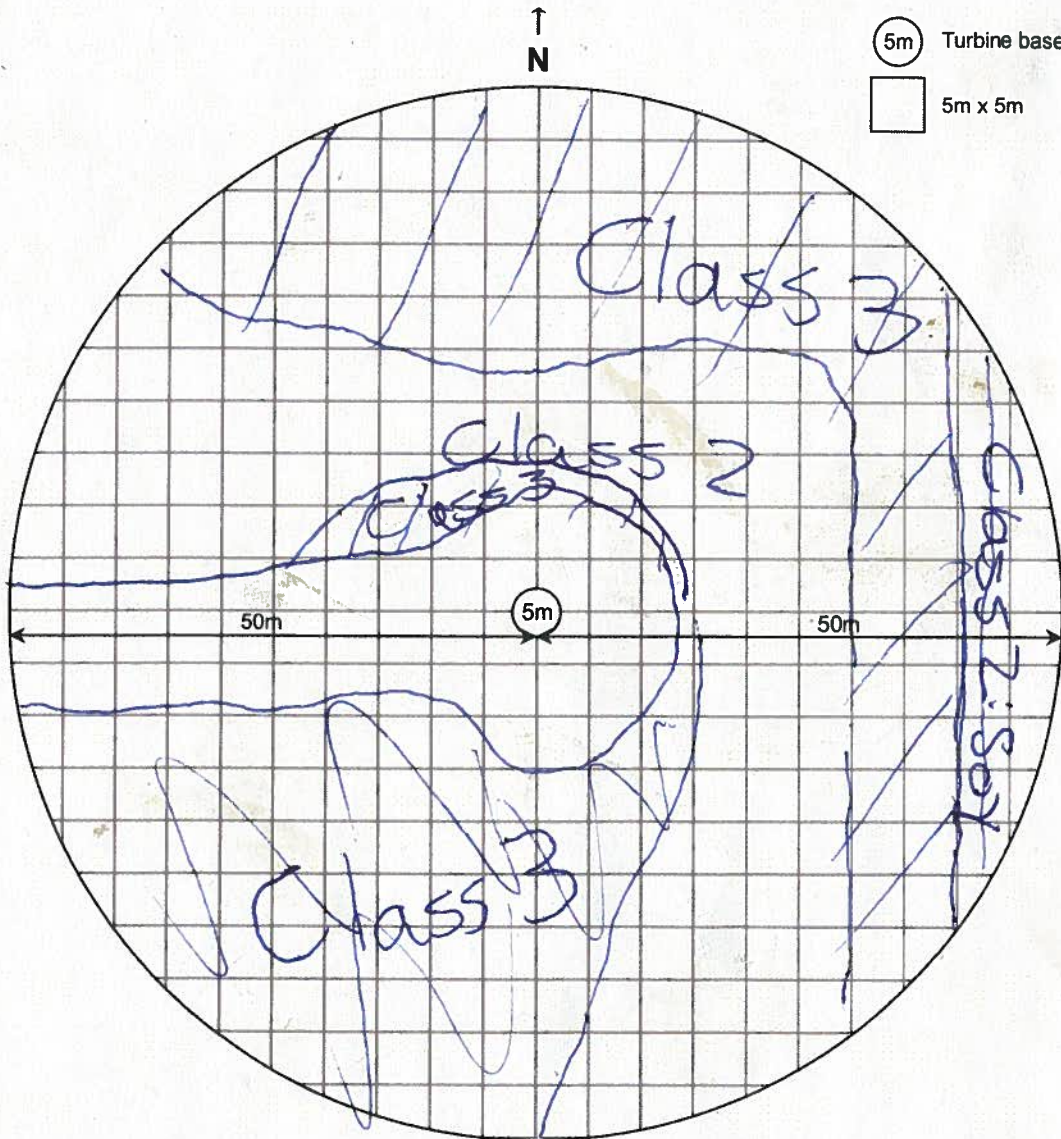

Project Number: 160961010

Project Name: Adelaide Wind Farm

Date Initiated: Aug 4 / 2015

Field Personnel: Ken Edwards

Turbine No.: 12

Total Area: 7,854 m<sup>2</sup>

Total Surveyable Area: 6895

% VEGETATION COVER	VEGETATION HEIGHT	VISIBILITY CLASS
≥ 90% bare ground	≤ 15cm tall	Class 1 (Easy)
≥ 25% bare ground	≤ 15cm tall	Class 2 (Moderate)
≤ 25% bare ground	≤ 25% > 30cm tall	Class 3 (Difficult)
Little or no bare ground	≥ 25% > 30cm tall	Class 4 (Very difficult)

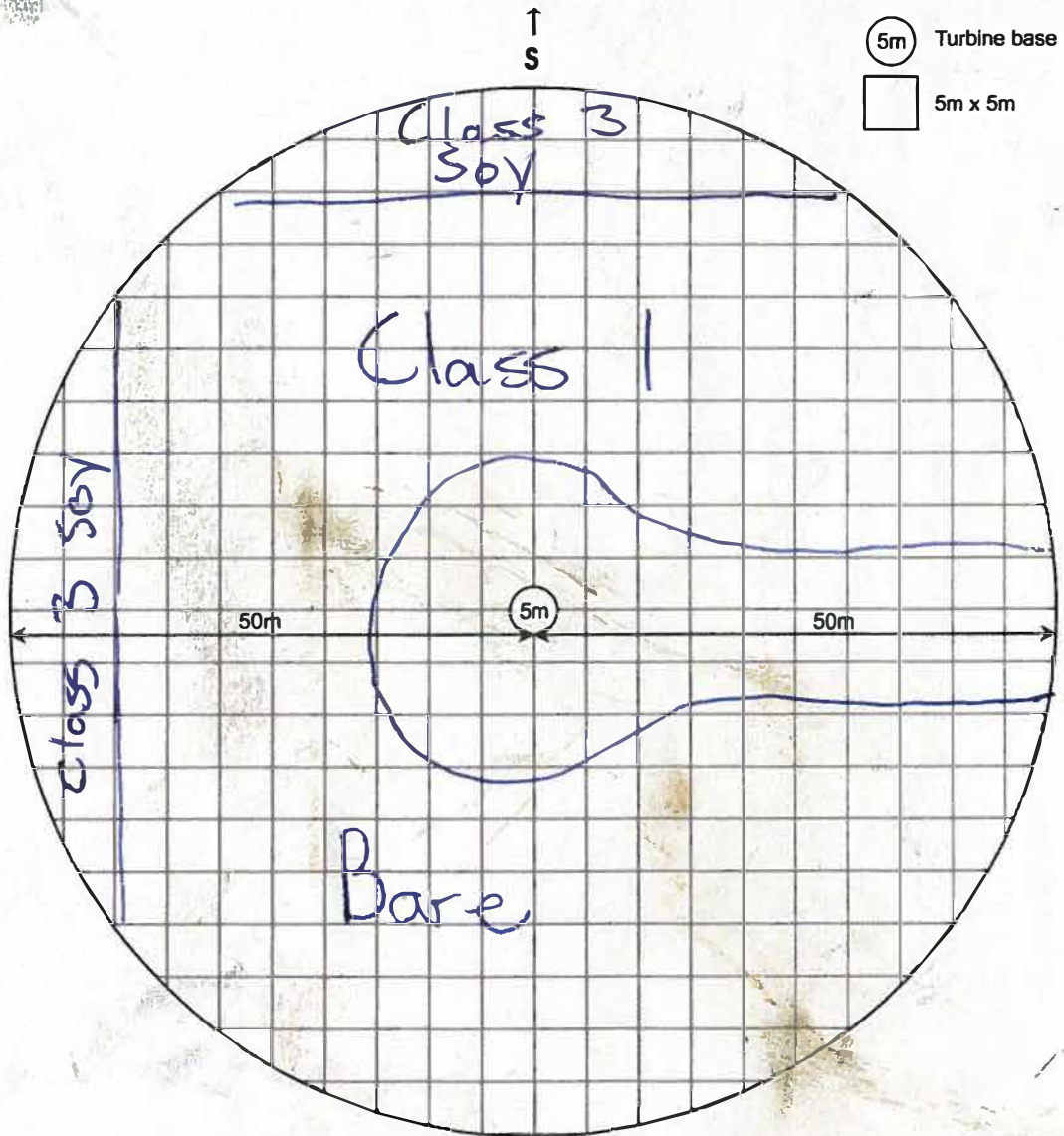

Project Number: 160961010  
Date Initiated: Sept. 28/2015

Project Name: Adelaide Wind Farm  
Field Personnel: Ken Edwards

Turbine No.: 12

Total Area: 7,854 m<sup>2</sup>

Total Surveyable Area: 7854

% VEGETATION COVER	VEGETATION HEIGHT	VISIBILITY CLASS
≥ 90% bare ground	≤ 15cm tall	Class 1 (Easy)
≥ 25% bare ground	≤ 15cm tall	Class 2 (Moderate)
≤ 25% bare ground	≤ 25% > 30cm tall	Class 3 (Difficult)
Little or no bare ground	≥ 25% > 30cm tall	Class 4 (Very difficult)

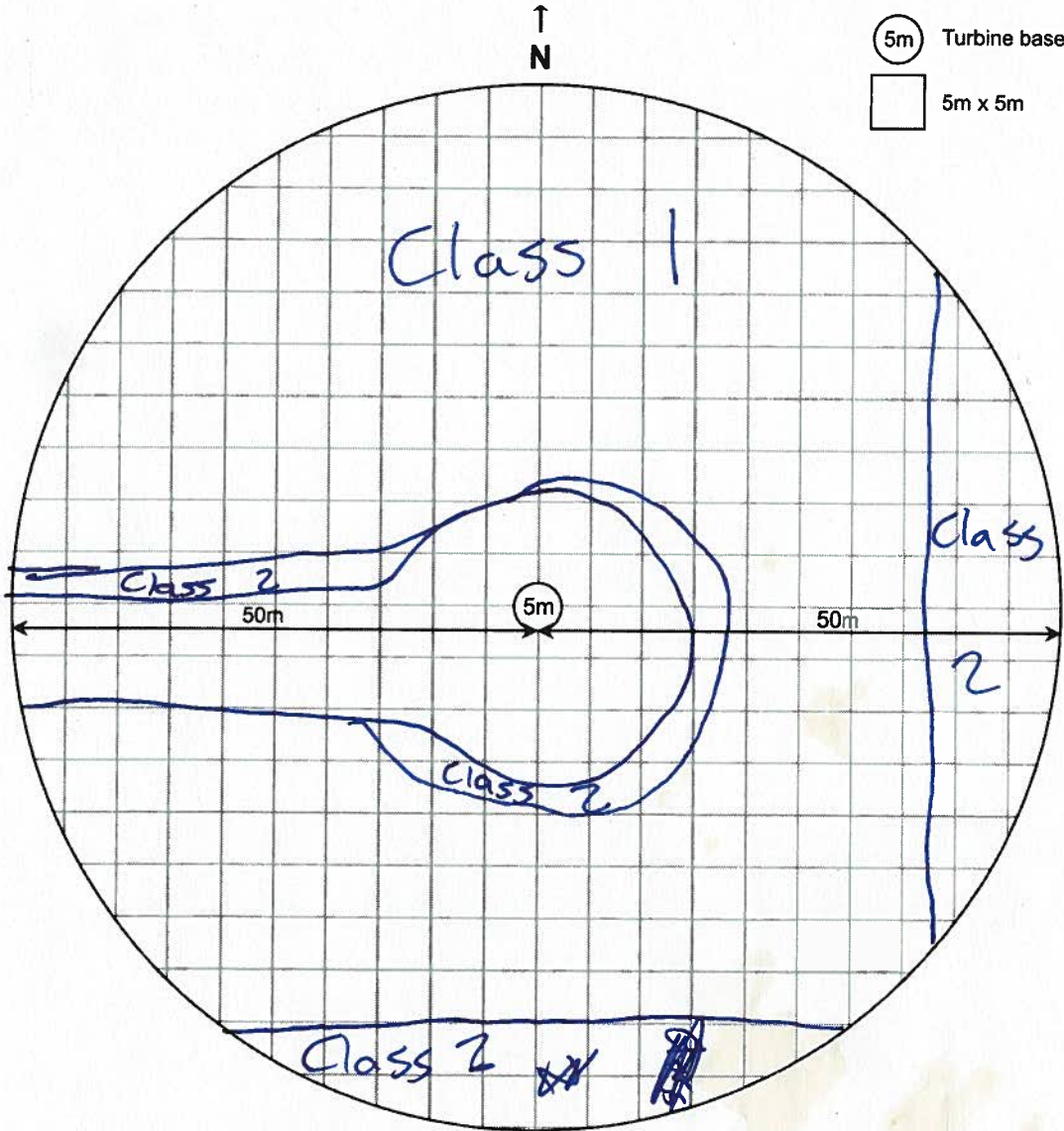

5m Turbine base  
5m x 5m

Project Number: 160961010

Project Name: Adelaide Wind Farm

Date Initiated: Oct 5 / 2015

Field Personnel: Ken Edwards

Turbine No.: 12

Total Area: 7,854 m<sup>2</sup>

Total Surveyable Area: 7854

% VEGETATION COVER	VEGETATION HEIGHT	VISIBILITY CLASS
≥ 90% bare ground	≤ 15cm tall	Class 1 (Easy)
≥ 25% bare ground	≤ 15cm tall	Class 2 (Moderate)
≤ 25% bare ground	≤ 25% > 30cm tall	Class 3 (Difficult)
Little or no bare ground	≥ 25% > 30cm tall	Class 4 (Very difficult)

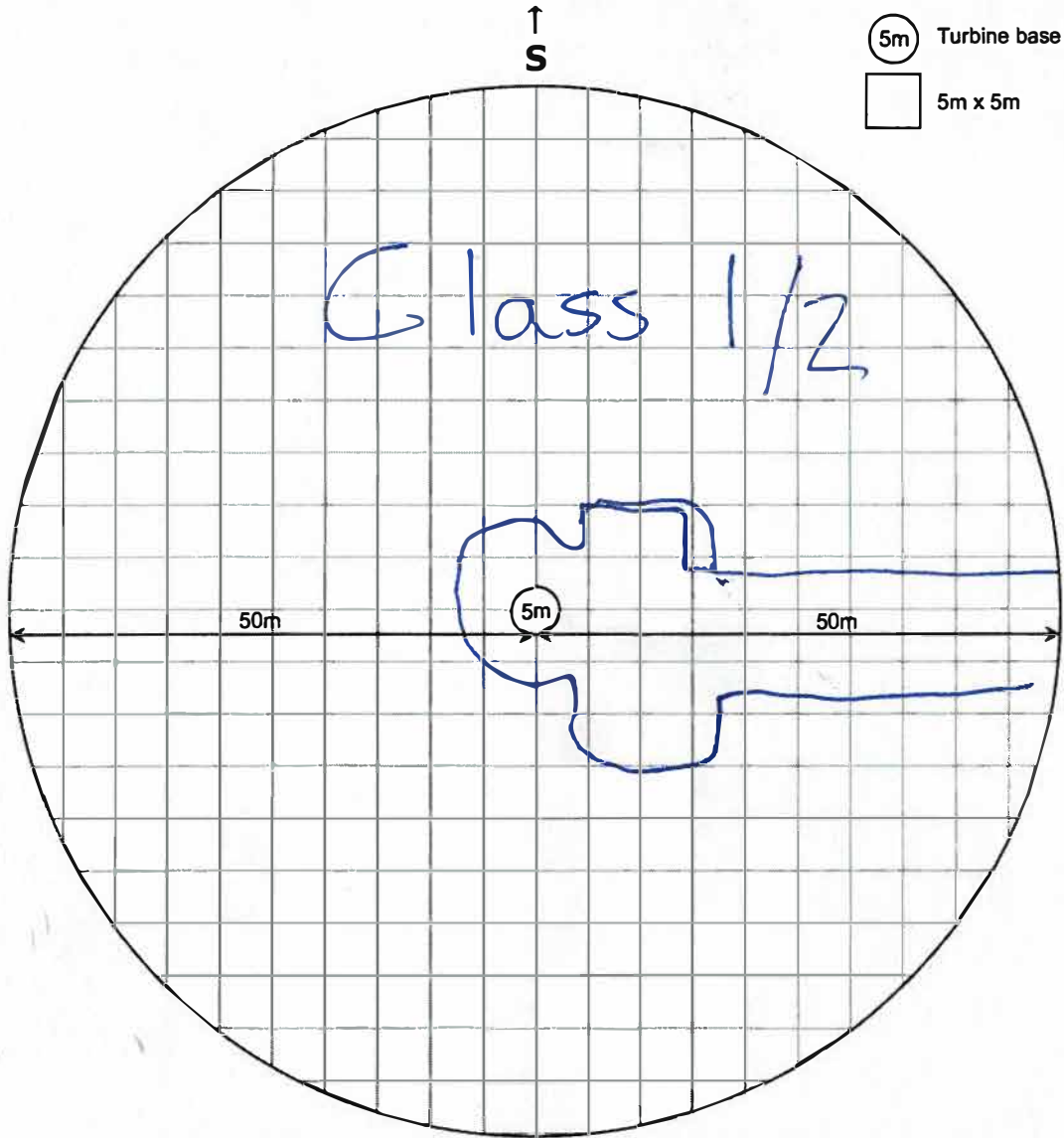

Project Number: 160961010

Project Name: Adelaide Wind Farm

Date Initiated: May 4 / 2015

Field Personnel: Ken Edwards

Turbine No.: 14

Total Area: 7,854 m<sup>2</sup>

Total Surveyable Area: 7854 m<sup>2</sup>

% VEGETATION COVER	VEGETATION HEIGHT	VISIBILITY CLASS
≥ 90% bare ground	≤ 15cm tall	Class 1 (Easy)
≥ 25% bare ground	≤ 15cm tall	Class 2 (Moderate)
≤ 25% bare ground	≤ 25% > 30cm tall	Class 3 (Difficult)
Little or no bare ground	≥ 25% > 30cm tall	Class 4 (Very difficult)

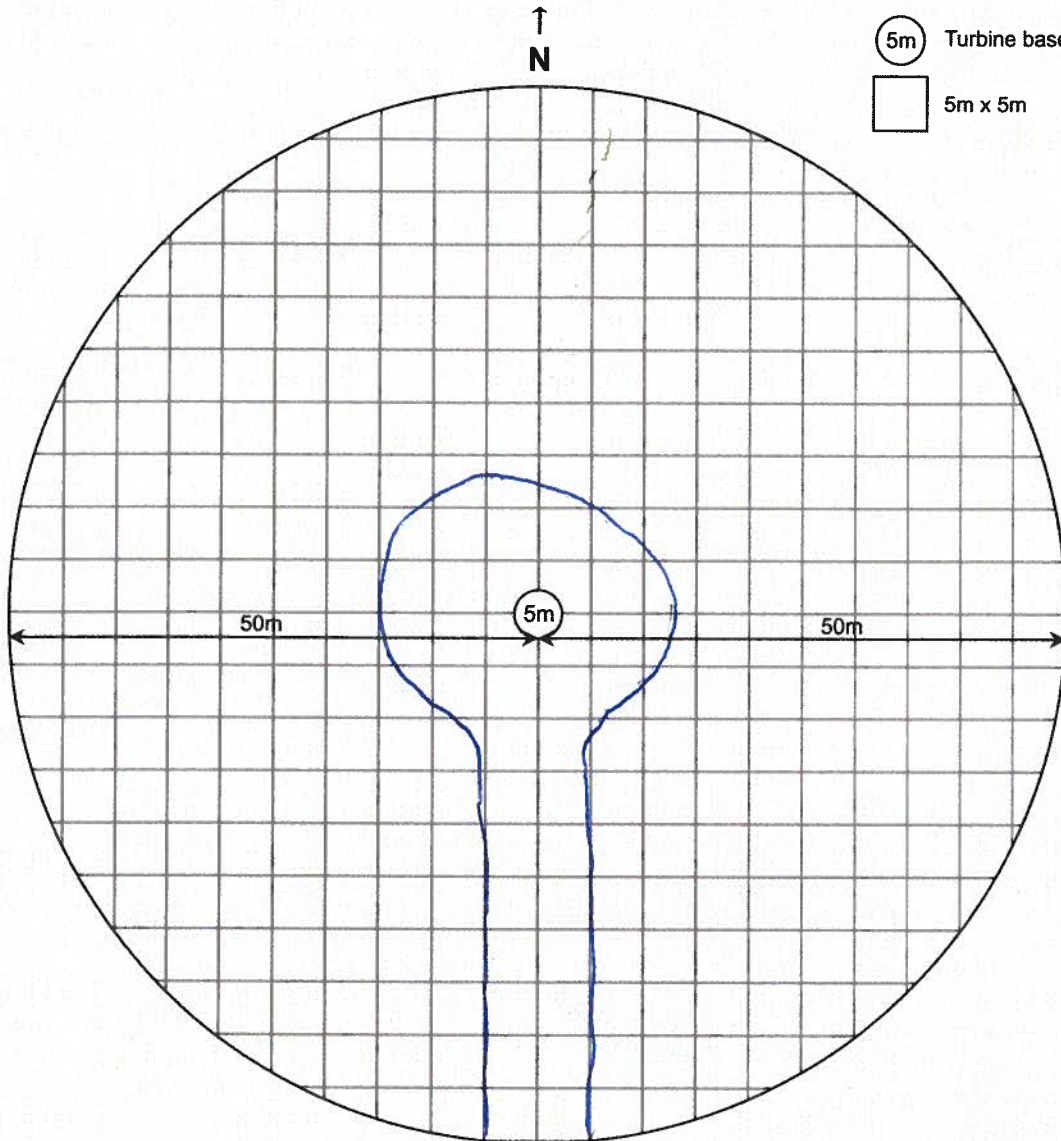

Project Number: 160961010

Project Name: Adelaide Wind Farm

Date Initiated: June 24 / 2015

Field Personnel: Ken Edwards

Turbine No.: 14

Total Area: 7,854 m<sup>2</sup>

Total Surveyable Area: 7854

% VEGETATION COVER	VEGETATION HEIGHT	VISIBILITY CLASS
≥ 90% bare ground	≤ 15cm tall	Class 1 (Easy)
≥ 25% bare ground	≤ 15cm tall	Class 2 (Moderate)
≤ 25% bare ground	≤ 25% > 30cm tall	Class 3 (Difficult)
Little or no bare ground	≥ 25% > 30cm tall	Class 4 (Very difficult)

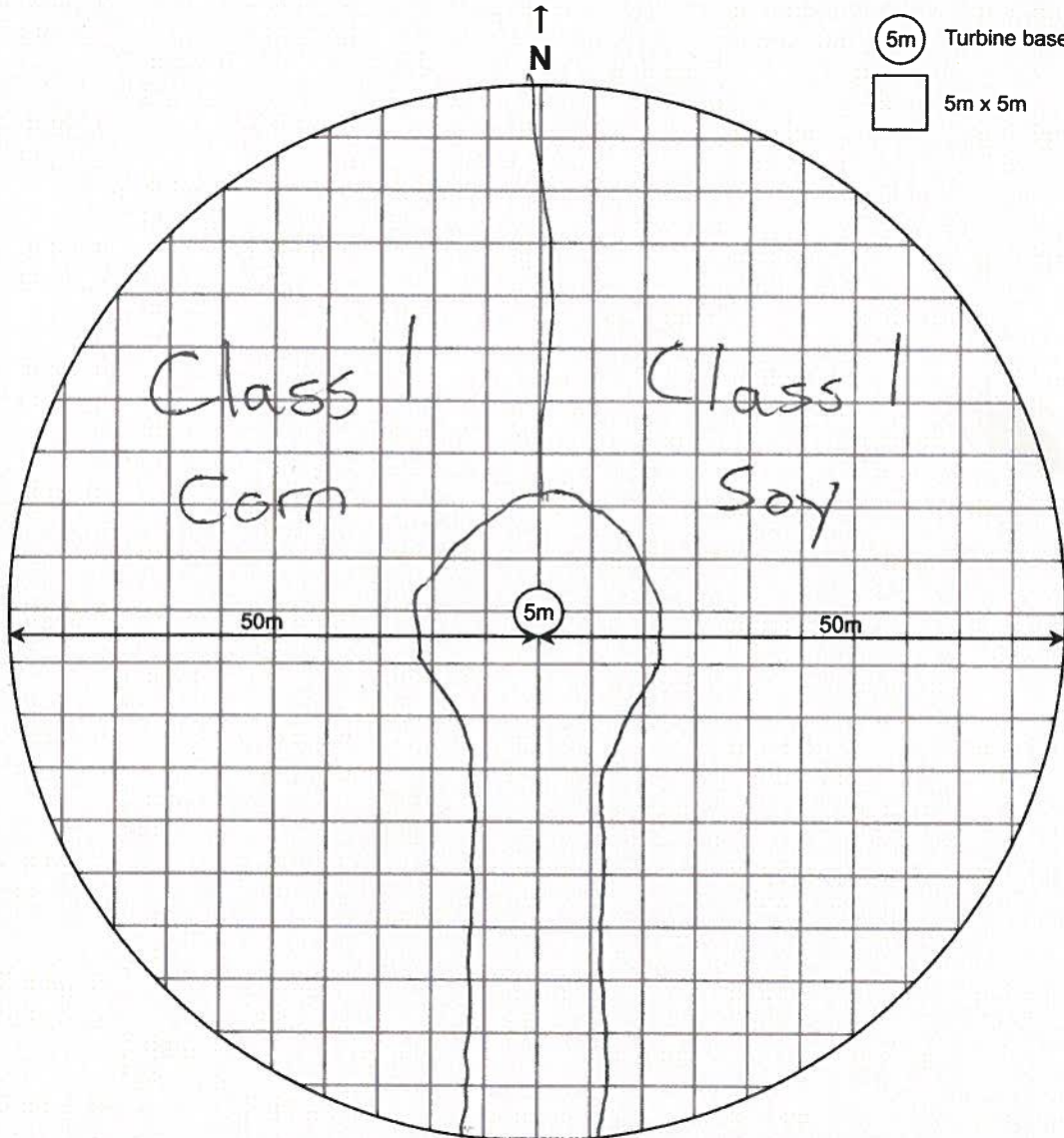

Project Number: 160961010

Project Name: Adelaide Wind Farm

Date Initiated: July 8/2015

Field Personnel: Ken Edwards

Turbine No.: 14

Total Area: 7,854 m<sup>2</sup>

Total Surveyable Area: 7854

% VEGETATION COVER	VEGETATION HEIGHT	VISIBILITY CLASS
≥ 90% bare ground	≤ 15cm tall	Class 1 (Easy)
≥ 25% bare ground	≤ 15cm tall	Class 2 (Moderate)
≤ 25% bare ground	≤ 25% > 30cm tall	Class 3 (Difficult)
Little or no bare ground	≥ 25% > 30cm tall	Class 4 (Very difficult)

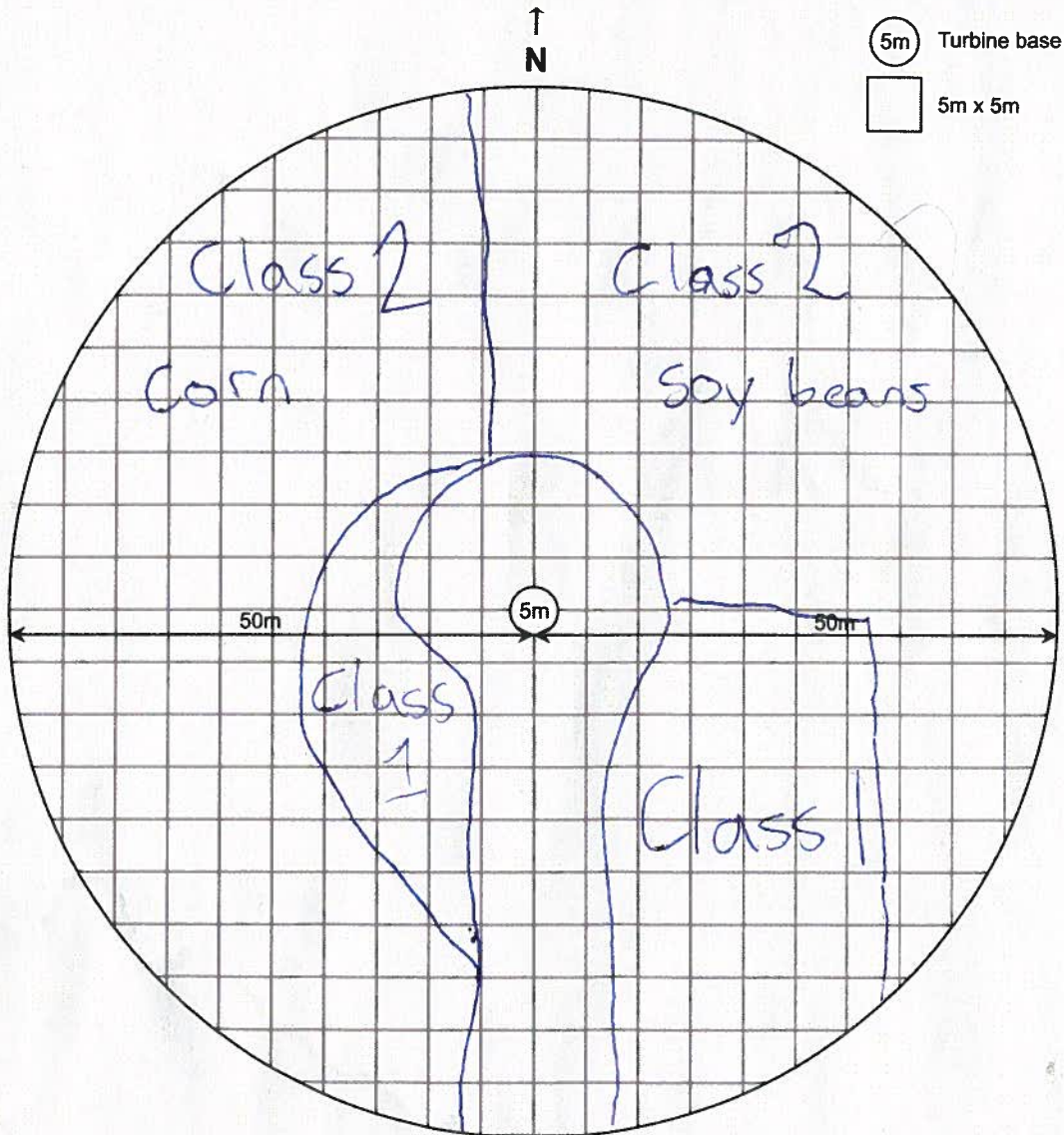



Project Number: 160961010

Project Name: Adelaide Wind Farm

Date Initiated: Aug 4, 2015

Field Personnel: Ken Edwards

Turbine No.: 14

Total Area: 7,854 m<sup>2</sup>

Total Surveyable Area: 3925

% VEGETATION COVER	VEGETATION HEIGHT	VISIBILITY CLASS
≥ 90% bare ground	≤ 15cm tall	Class 1 (Easy)
≥ 25% bare ground	≤ 15cm tall	Class 2 (Moderate)
≤ 25% bare ground	≤ 25% > 30cm tall	Class 3 (Difficult)
Little or no bare ground	≥ 25% > 30cm tall	Class 4 (Very difficult)

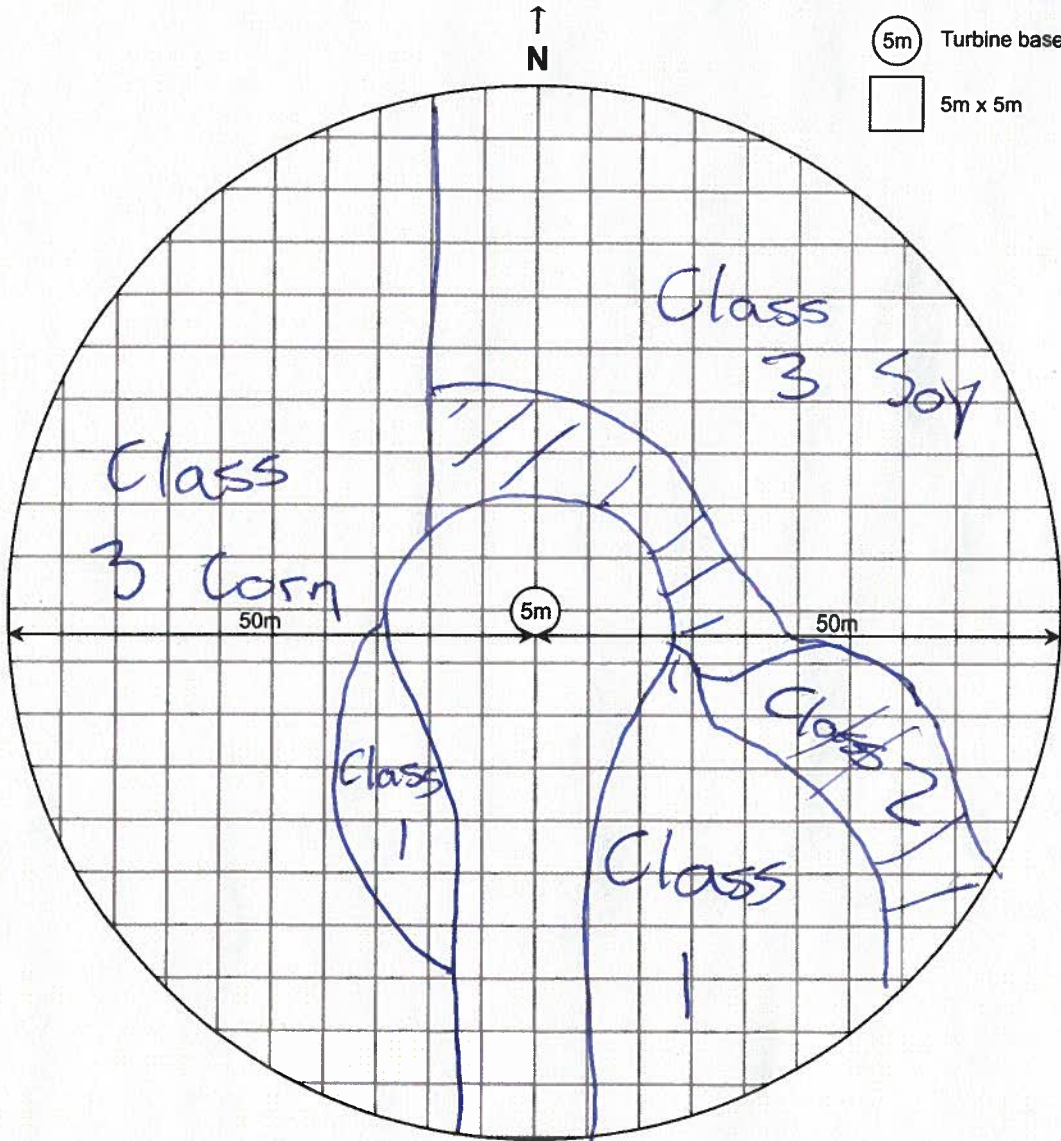

Project Number: 160961010

Project Name: Adelaide Wind Farm

Date Initiated: Oct 8/2015

Field Personnel: Ken Edwards

Turbine No.: 14

Total Area: 7,854 m<sup>2</sup>

Total Surveyable Area: 3925

% VEGETATION COVER	VEGETATION HEIGHT	VISIBILITY CLASS
≥ 90% bare ground	≤ 15cm tall	Class 1 (Easy)
≥ 25% bare ground	≤ 15cm tall	Class 2 (Moderate)
≤ 25% bare ground	≤ 25% > 30cm tall	Class 3 (Difficult)
Little or no bare ground	≥ 25% > 30cm tall	Class 4 (Very difficult)

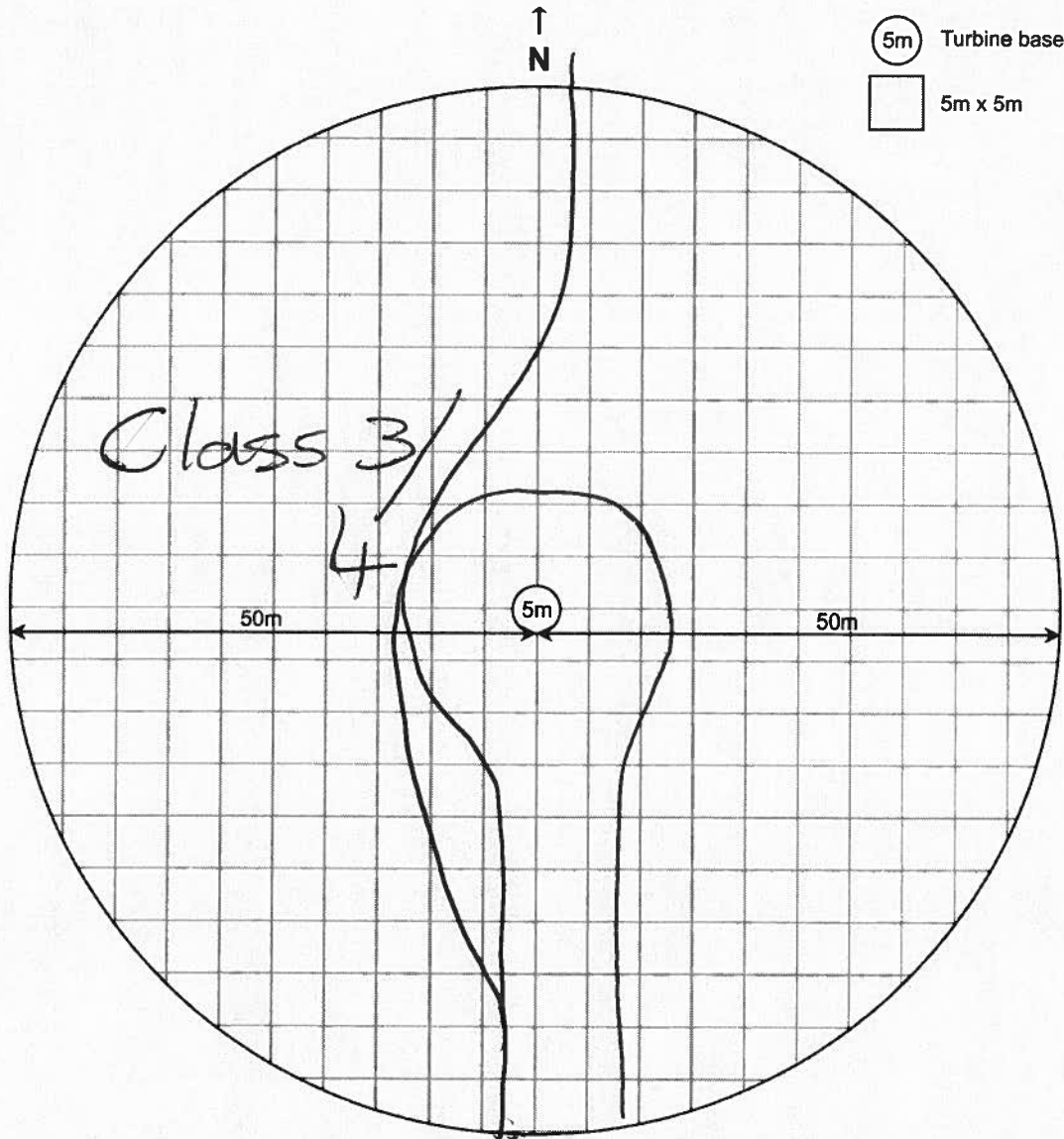

Project Number: 160961010  
Date Initiated: Oct 12/2015

Project Name: Adelaide Wind Farm  
Field Personnel: Ken Edwards

Turbine No.: 14

Total Area: 7,854 m<sup>2</sup>

Total Surveyable Area: ~~7,854~~ 4,712

% VEGETATION COVER	VEGETATION HEIGHT	VISIBILITY CLASS
≥ 90% bare ground	≤ 15cm tall	Class 1 (Easy)
≥ 25% bare ground	≤ 15cm tall	Class 2 (Moderate)
≤ 25% bare ground	≤ 25% > 30cm tall	Class 3 (Difficult)
Little or no bare ground	≥ 25% > 30cm tall	Class 4 (Very difficult)

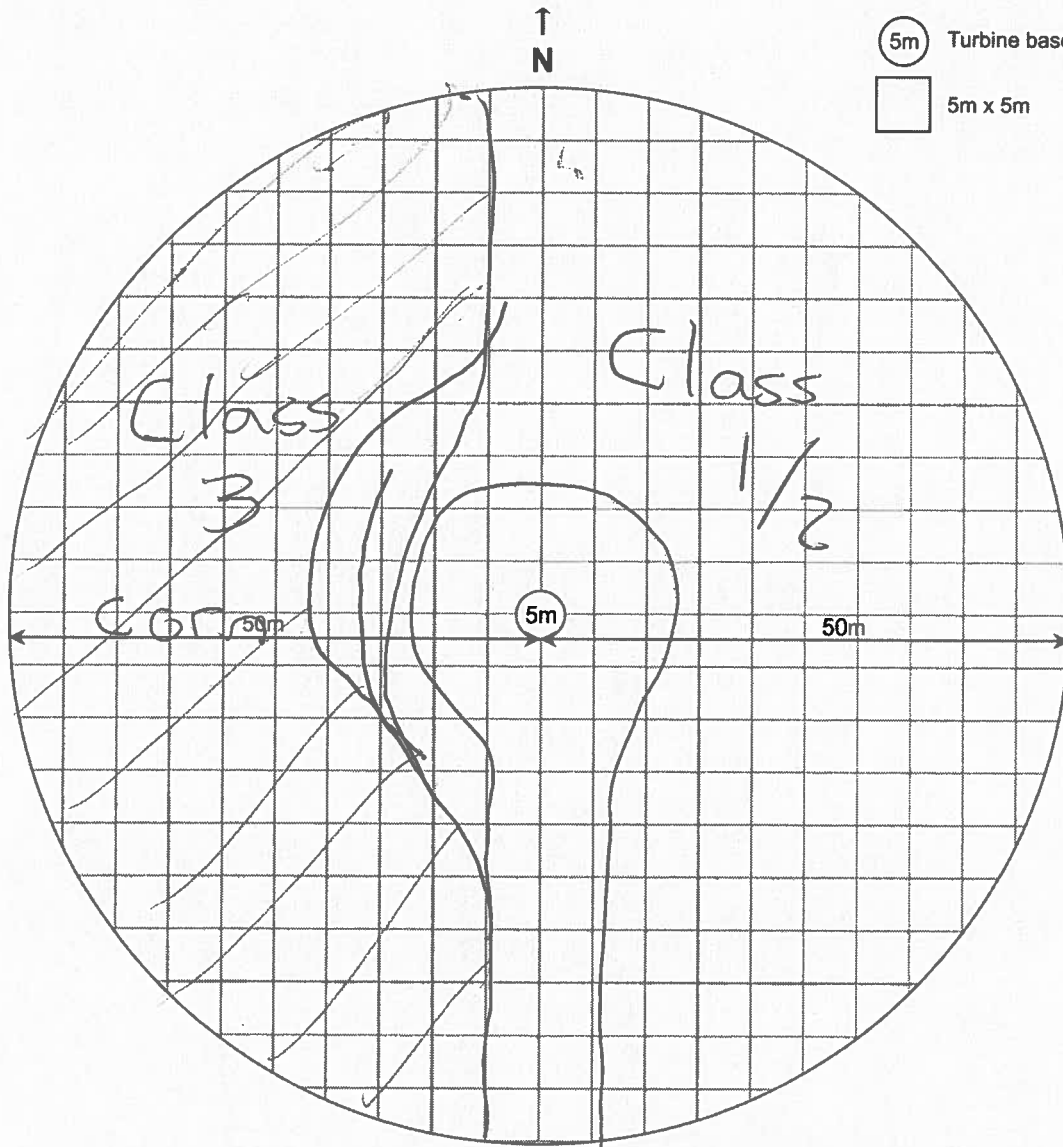

Project Number: 160961010

Project Name: Adelaide Wind Farm

Date Initiated: Oct 15/2015

Field Personnel: Ken Edwards



Turbine No.: 14

Total Area: 7,854 m<sup>2</sup>

Total Surveyable Area: 4712

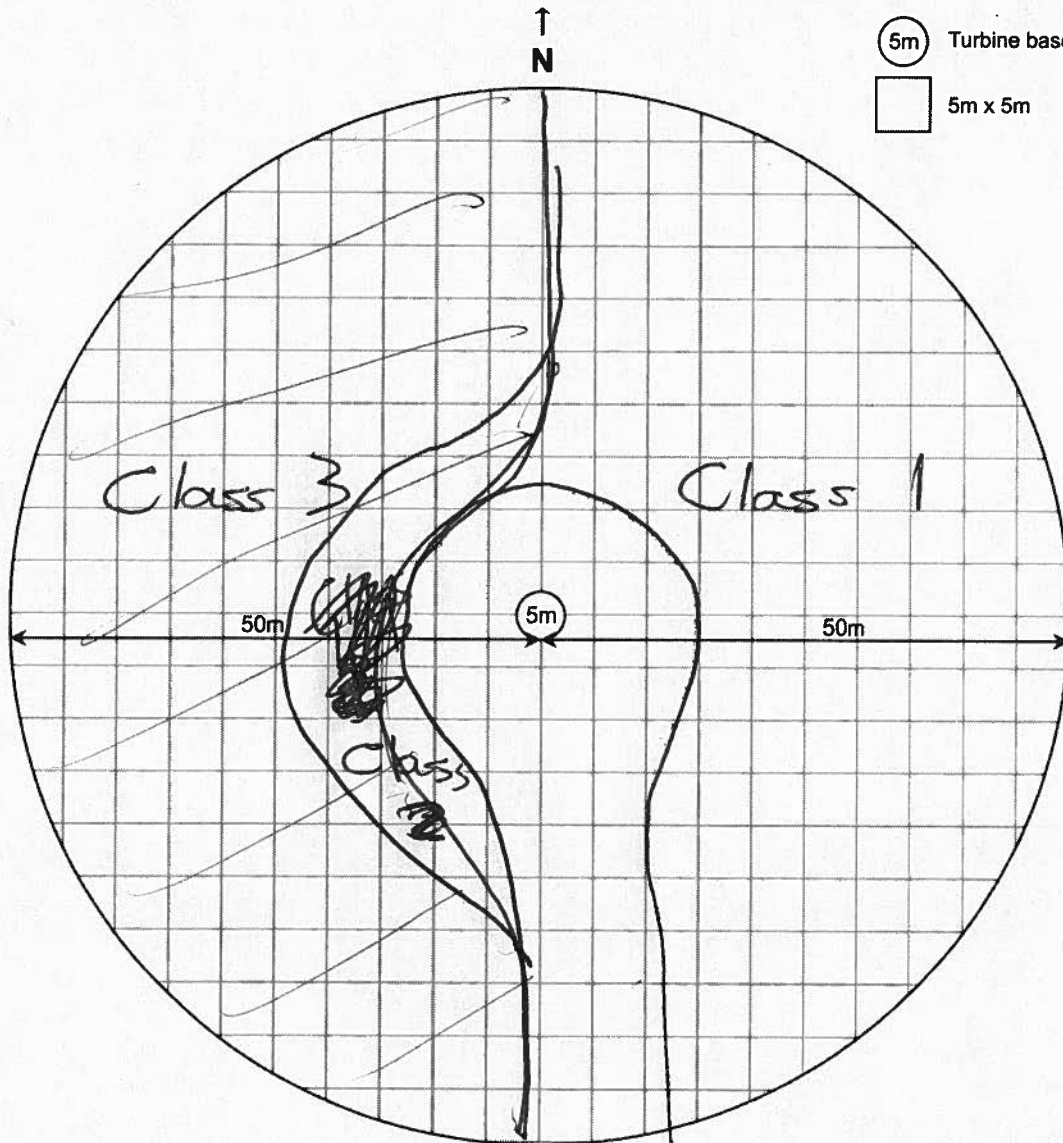
% VEGETATION COVER	VEGETATION HEIGHT	VISIBILITY CLASS
≥ 90% bare ground	≤ 15cm tall	Class 1 (Easy)
≥ 25% bare ground	≤ 15cm tall	Class 2 (Moderate)
≤ 25% bare ground	≤ 25% > 30cm tall	Class 3 (Difficult)
Little or no bare ground	≥ 25% > 30cm tall	Class 4 (Very difficult)



 Turbine base  
 5m x 5m

Project Number: 160961010  
Date Initiated: Oct 25/2015

Project Name: Adelaide Wind Farm  
Field Personnel: Ken Edwards

Turbine No.: 14  
Total Area: 7,854 m<sup>2</sup>  
Total Surveyable Area: 7854

% VEGETATION COVER	VEGETATION HEIGHT	VISIBILITY CLASS
≥ 90% bare ground	≤ 15cm tall	Class 1 (Easy)
≥ 25% bare ground	≤ 15cm tall	Class 2 (Moderate)
≤ 25% bare ground	≤ 25% > 30cm tall	Class 3 (Difficult)
Little or no bare ground	≥ 25% > 30cm tall	Class 4 (Very difficult)

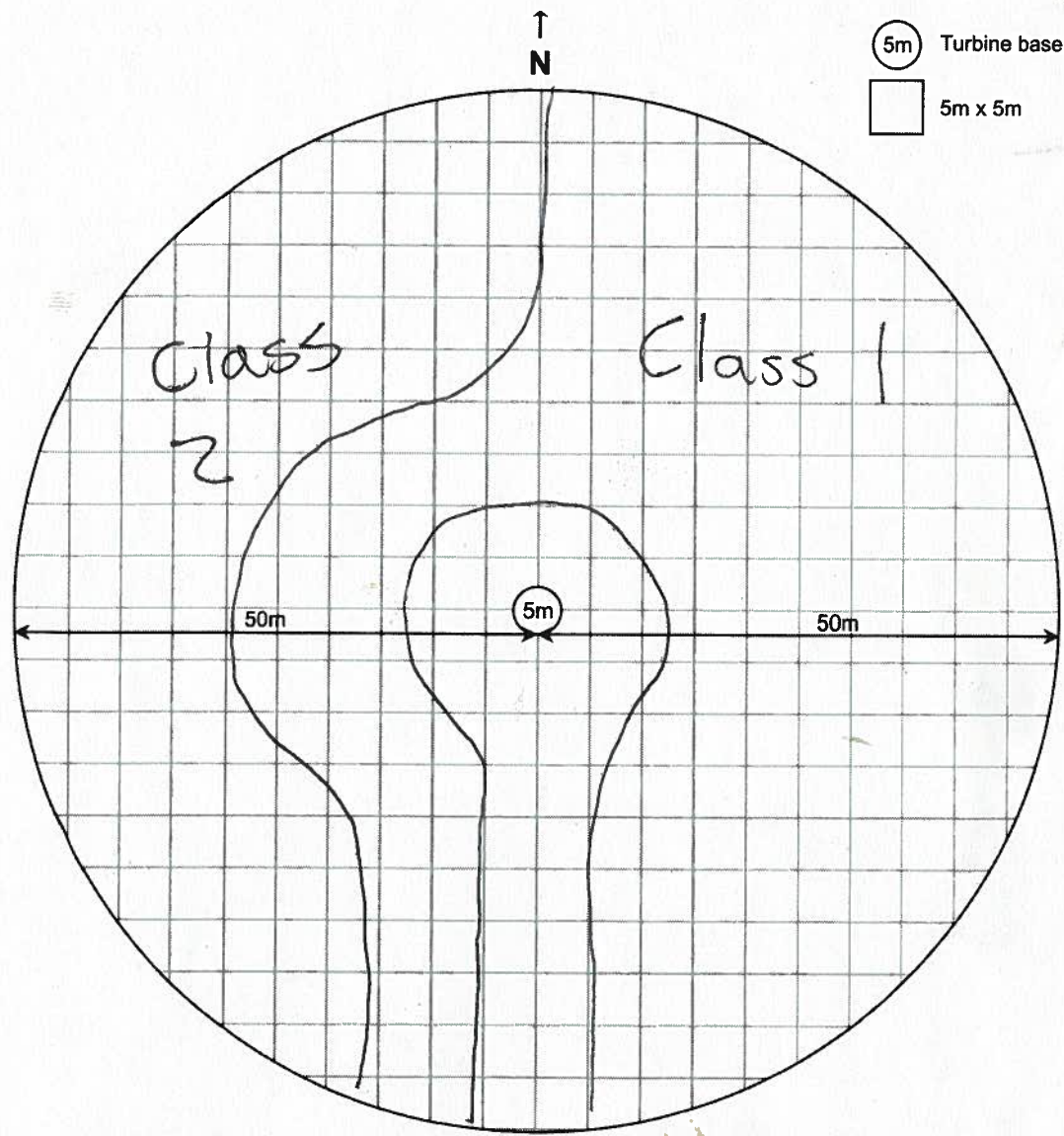

Project Number: 160961010

Project Name: Adelaide Wind Farm

Date Initiated: May 4/2015

Field Personnel: Ken Edwards

Turbine No.: 17

Total Area: 7,854 m<sup>2</sup>

Total Surveyable Area: 7854

% VEGETATION COVER	VEGETATION HEIGHT	VISIBILITY CLASS
≥ 90% bare ground	≤ 15cm tall	Class 1 (Easy)
≥ 25% bare ground	≤ 15cm tall	Class 2 (Moderate)
≤ 25% bare ground	≤ 25% > 30cm tall	Class 3 (Difficult)
Little or no bare ground	≥ 25% > 30cm tall	Class 4 (Very difficult)

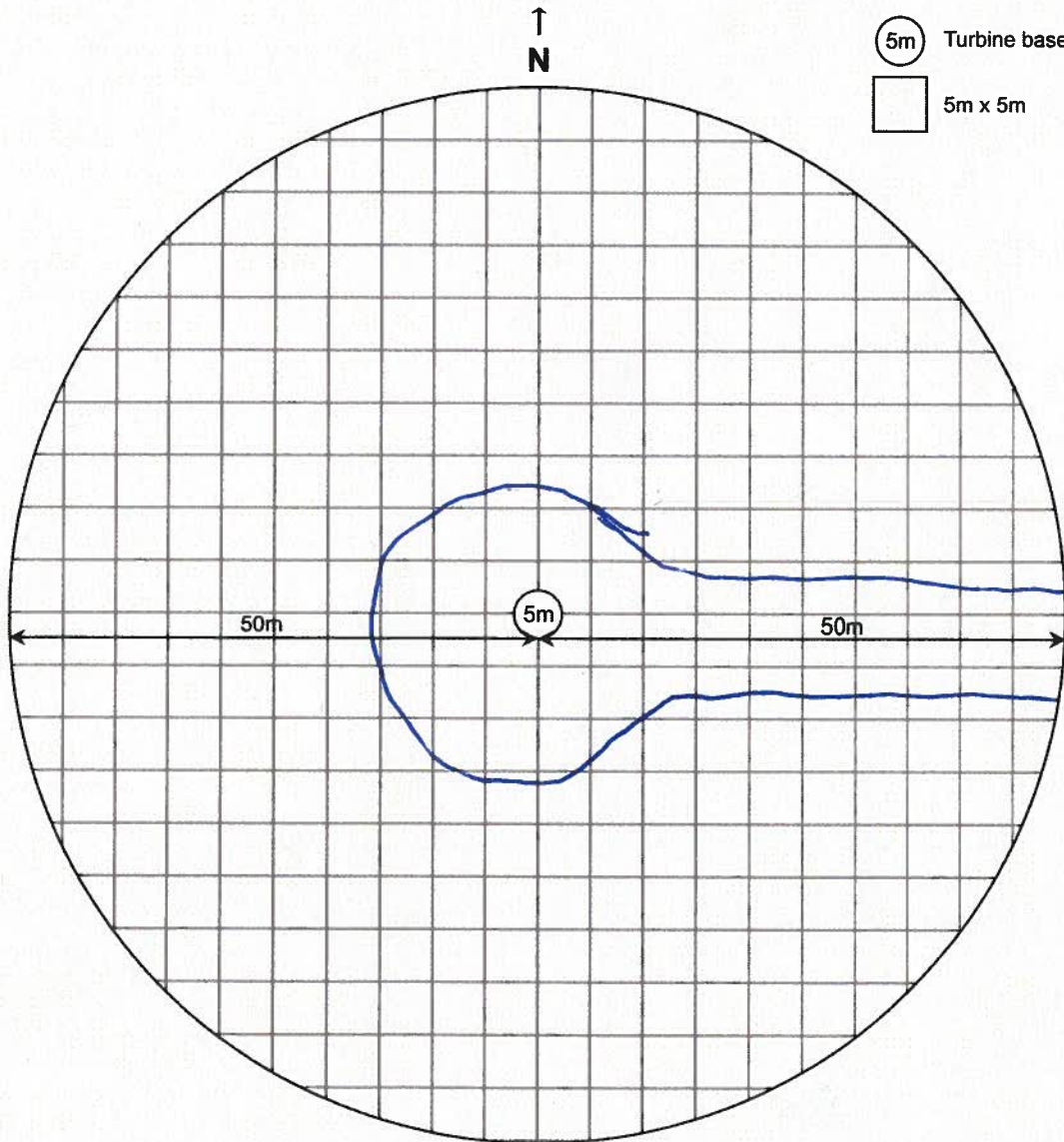

Project Number: 160961010

Project Name: Adelaide Wind Farm

Date Initiated: May 19, 2015

Field Personnel: Ken Edwards

Turbine No.: 17

Total Area: 7,854 m<sup>2</sup>

Total Surveyable Area: 7854

% VEGETATION COVER	VEGETATION HEIGHT	VISIBILITY CLASS
≥ 90% bare ground	≤ 15cm tall	Class 1 (Easy)
≥ 25% bare ground	≤ 15cm tall	Class 2 (Moderate)
≤ 25% bare ground	≤ 25% > 30cm tall	Class 3 (Difficult)
Little or no bare ground	≥ 25% > 30cm tall	Class 4 (Very difficult)

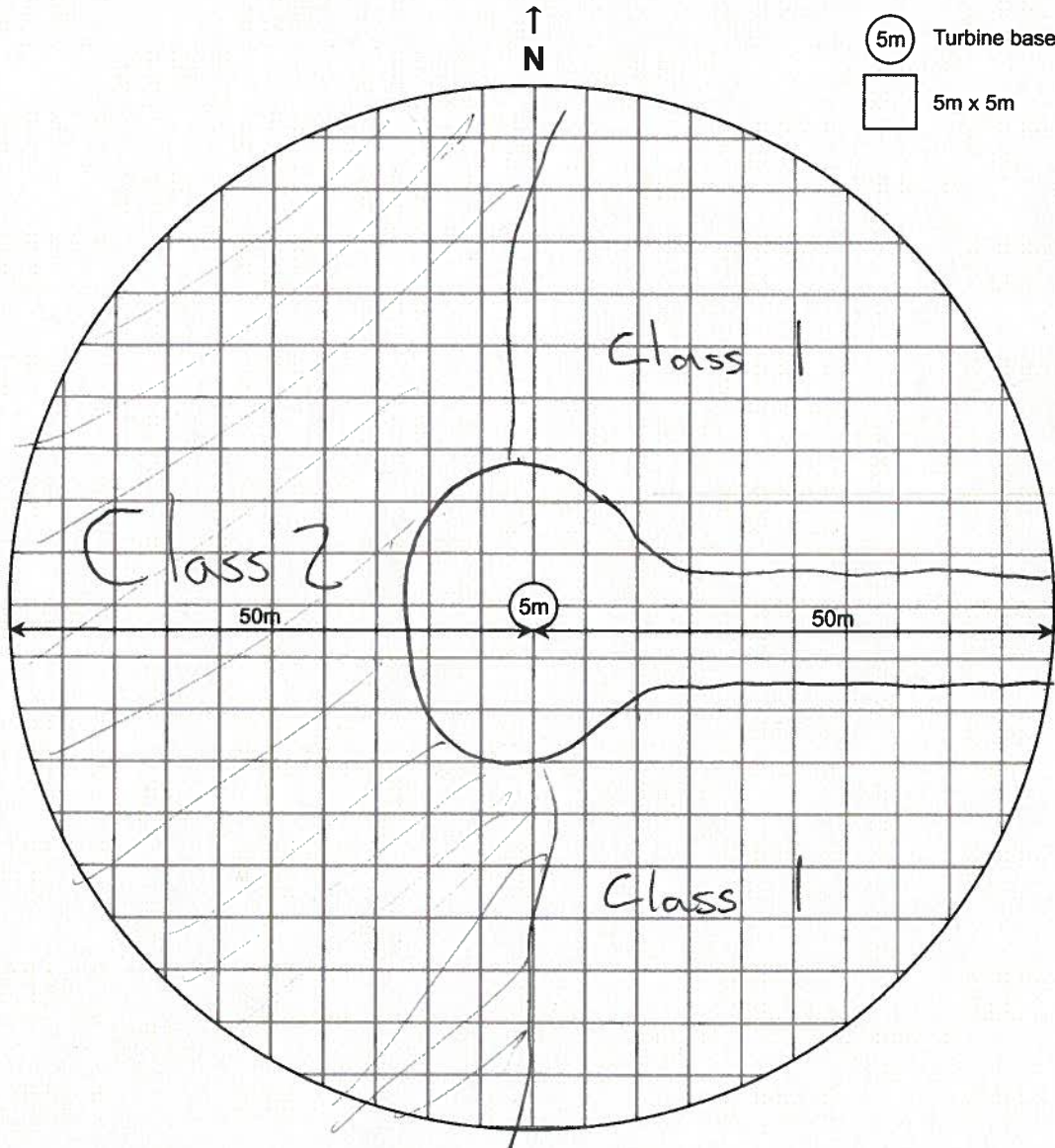

Project Number: 160961010

Project Name: Adelaide Wind Farm

Date Initiated: May 28 / 2015

Field Personnel: Ken Edwards

Turbine No.: 17

Total Area: 7,854 m<sup>2</sup>

Total Surveyable Area: 3992 m<sup>2</sup>

% VEGETATION COVER	VEGETATION HEIGHT	VISIBILITY CLASS
≥ 90% bare ground	≤ 15cm tall	Class 1 (Easy)
≥ 25% bare ground	≤ 15cm tall	Class 2 (Moderate)
≤ 25% bare ground	≤ 25% > 30cm tall	Class 3 (Difficult)
Little or no bare ground	≥ 25% > 30cm tall	Class 4 (Very difficult)

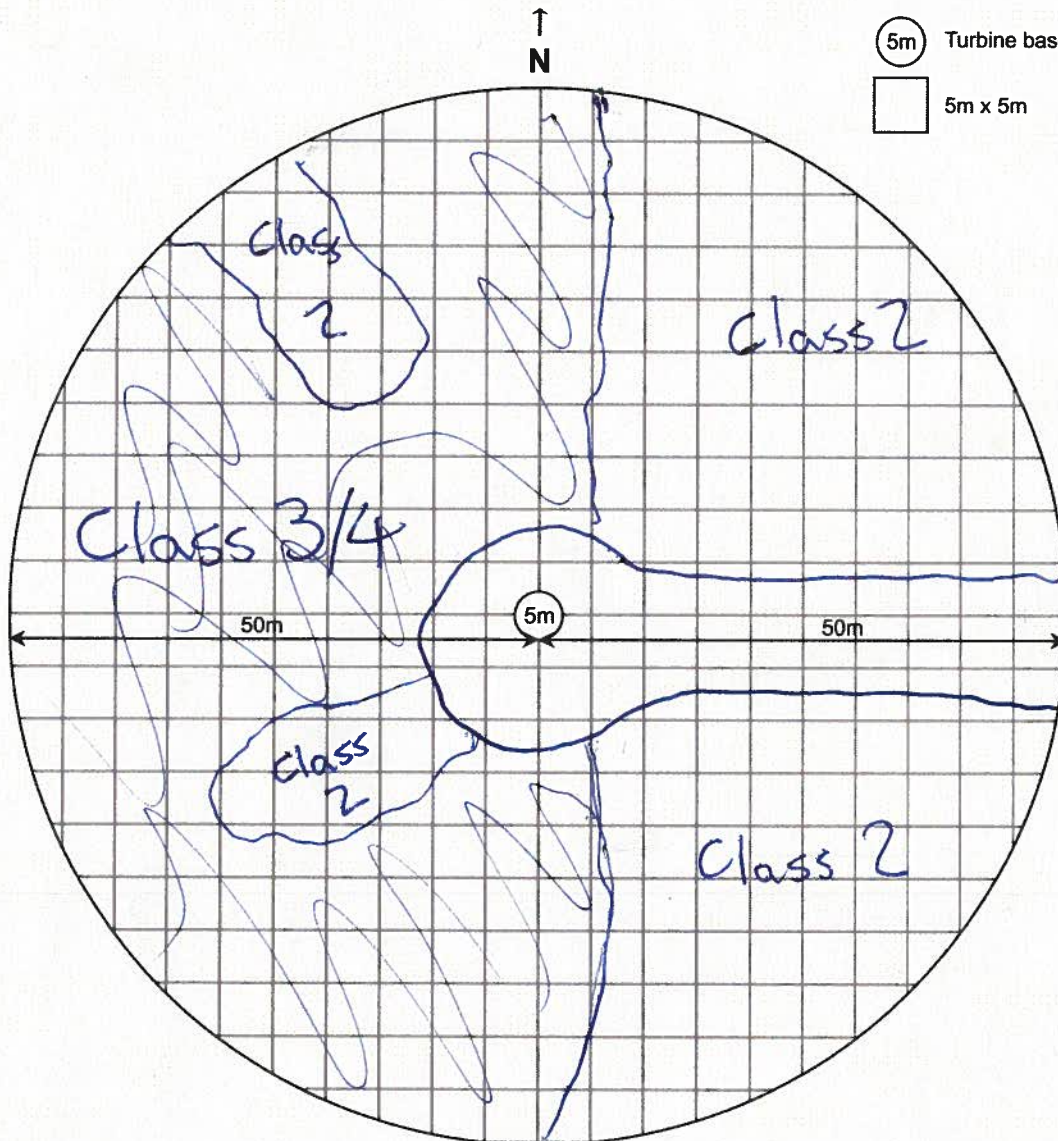



Project Number: 160961010

Project Name: Adelaide Wind Farm

Date Initiated: June 18 / 2015

Field Personnel: Ken Edwards

Turbine No.: 17

Total Area: 7,854 m<sup>2</sup>

Total Surveyable Area: 2638

% VEGETATION COVER	VEGETATION HEIGHT	VISIBILITY CLASS
≥ 90% bare ground	≤ 15cm tall	Class 1 (Easy)
≥ 25% bare ground	≤ 15cm tall	Class 2 (Moderate)
≤ 25% bare ground	≤ 25% > 30cm tall	Class 3 (Difficult)
Little or no bare ground	≥ 25% > 30cm tall	Class 4 (Very difficult)

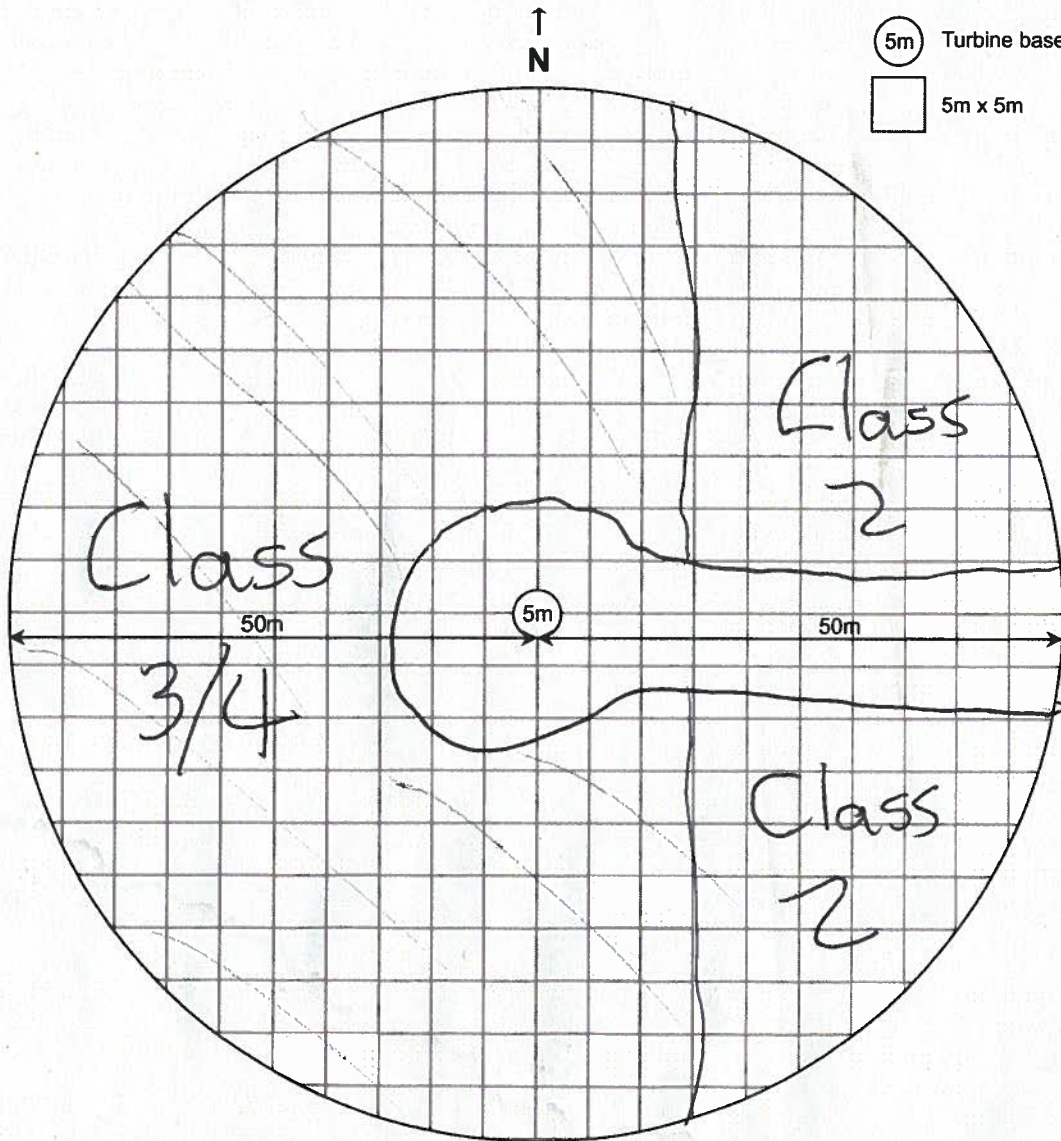

Project Number: 160961010

Project Name: Adelaide Wind Farm

Date Initiated: June 29, 2015

Field Personnel: Ken Edwards

Turbine No.: 17

Total Area: 7,854 m<sup>2</sup>

Total Surveyable Area: 4638.9

% VEGETATION COVER	VEGETATION HEIGHT	VISIBILITY CLASS
≥ 90% bare ground	≤ 15cm tall	Class 1 (Easy)
≥ 25% bare ground	≤ 15cm tall	Class 2 (Moderate)
≤ 25% bare ground	≤ 25% > 30cm tall	Class 3 (Difficult)
Little or no bare ground	≥ 25% > 30cm tall	Class 4 (Very difficult)

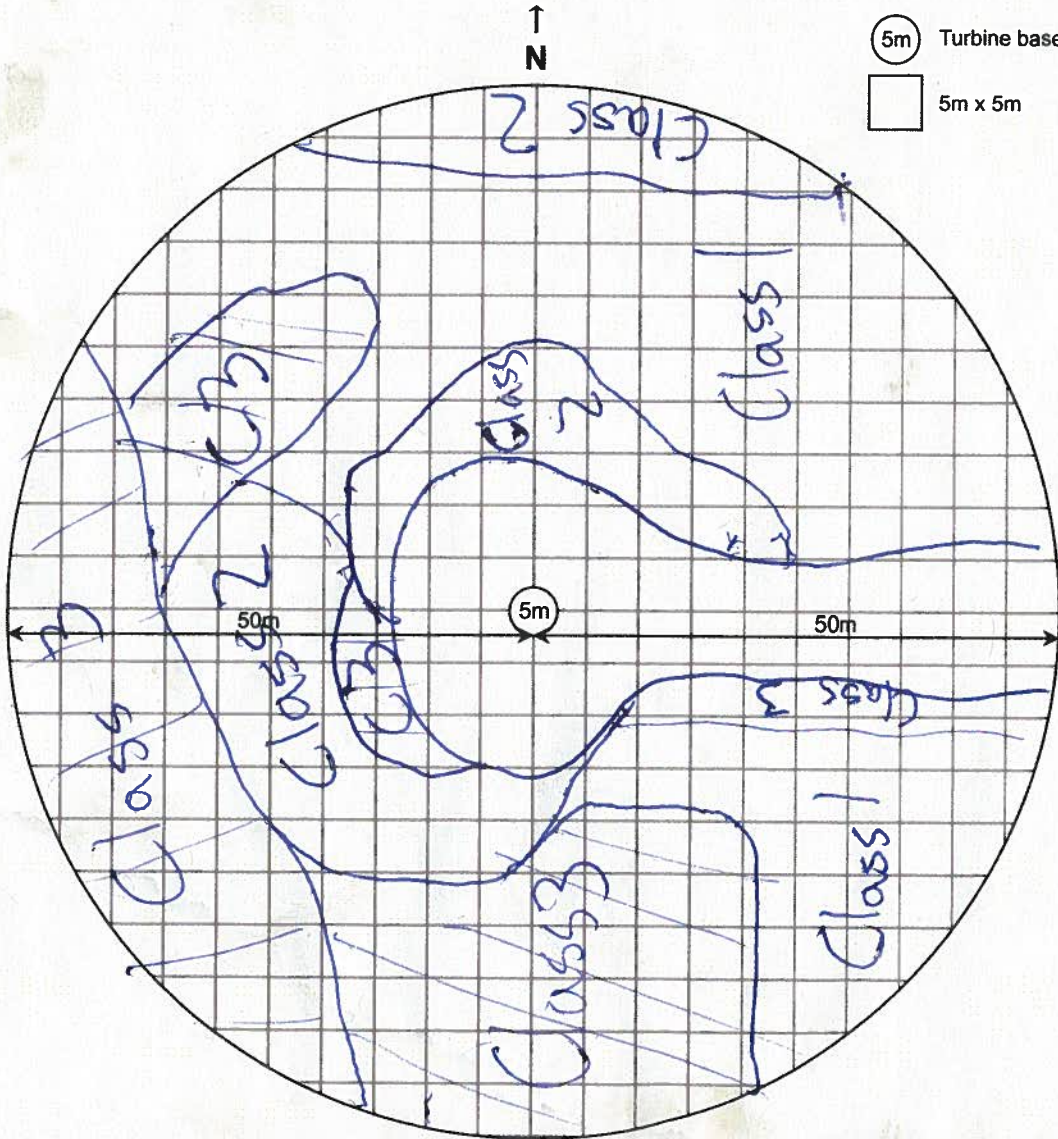

Project Number: 160961010

Project Name: Adelaide Wind Farm

Date Initiated: Aug 4, 2015

Field Personnel: Ken Edwards

Turbine No.: 17

Total Area: 7,854 m<sup>2</sup>

Total Surveyable Area: 7854

% VEGETATION COVER	VEGETATION HEIGHT	VISIBILITY CLASS
≥ 90% bare ground	≤ 15cm tall	Class 1 (Easy)
≥ 25% bare ground	≤ 15cm tall	Class 2 (Moderate)
≤ 25% bare ground	≤ 25% > 30cm tall	Class 3 (Difficult)
Little or no bare ground	≥ 25% > 30cm tall	Class 4 (Very difficult)

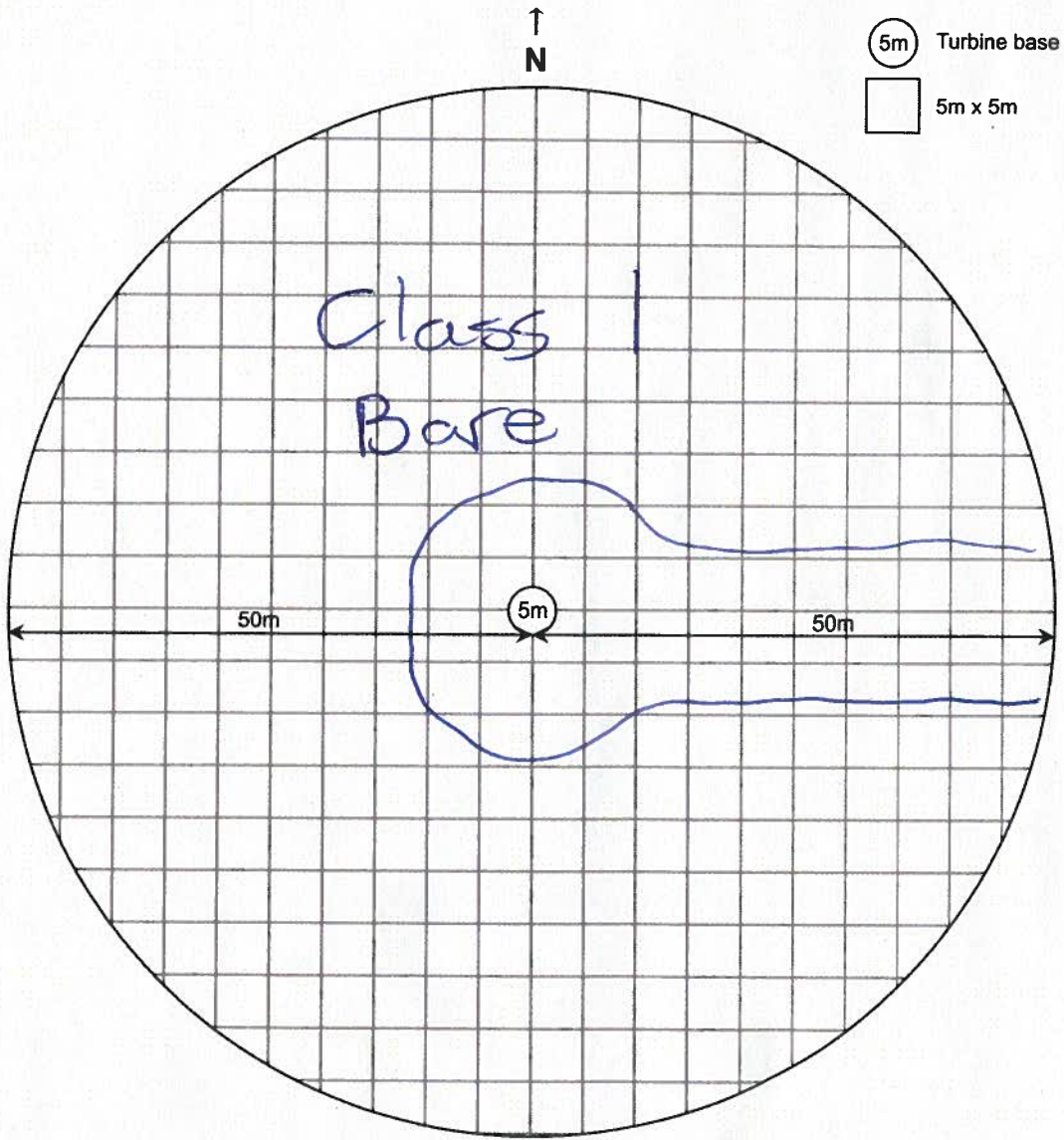

Project Number: 160961010

Project Name: Adelaide Wind Farm

Date Initiated: Sept. 3, 2015

Field Personnel: Ken Edwards

Turbine No.: 17

Total Area: 7,854 m<sup>2</sup>

Total Surveyable Area: 4953 m<sup>2</sup>

% VEGETATION COVER	VEGETATION HEIGHT	VISIBILITY CLASS
≥ 90% bare ground	≤ 15cm tall	Class 1 (Easy)
≥ 25% bare ground	≤ 15cm tall	Class 2 (Moderate)
≤ 25% bare ground	≤ 25% > 30cm tall	Class 3 (Difficult)
Little or no bare ground	≥ 25% > 30cm tall	Class 4 (Very difficult)

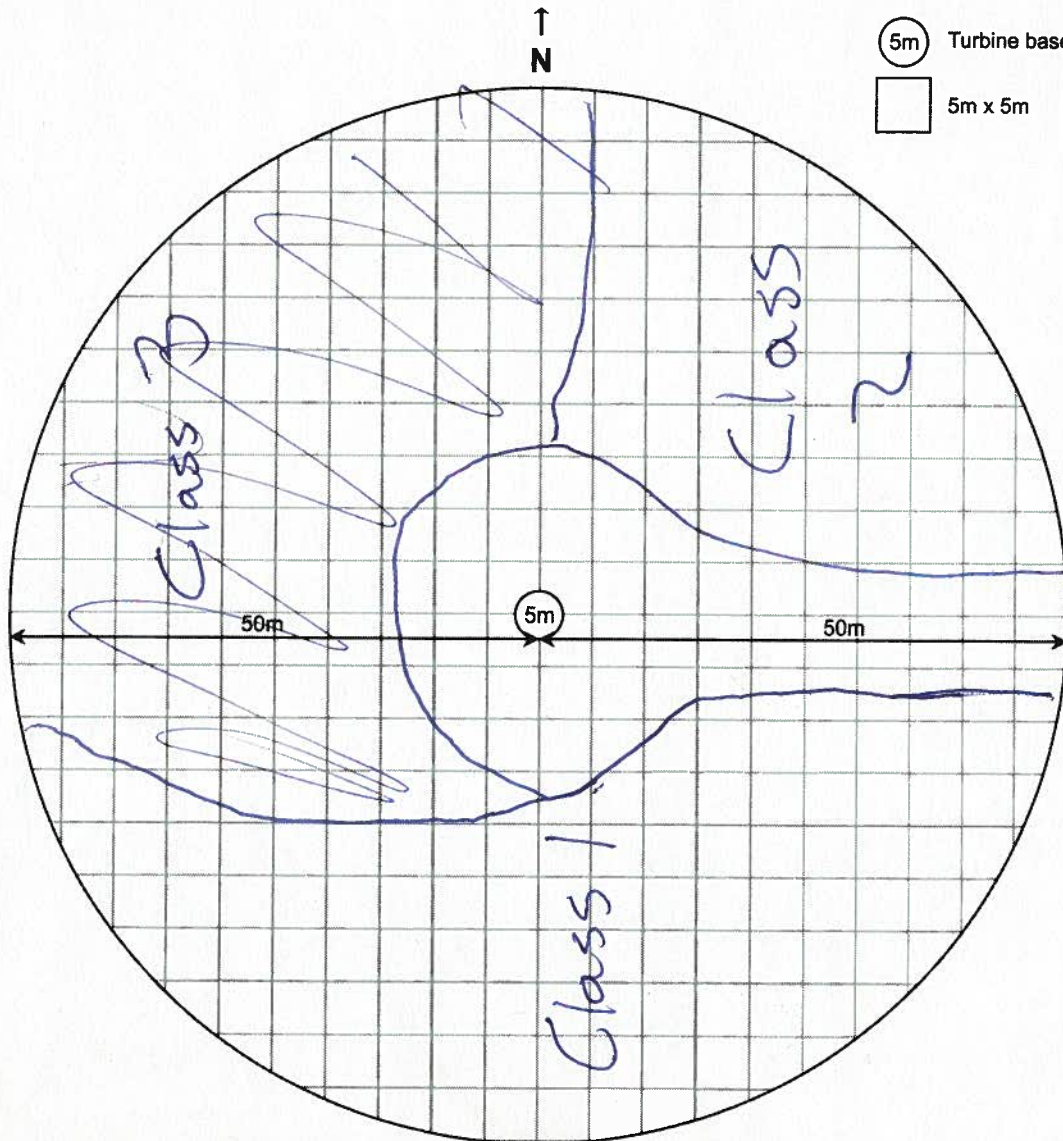

Project Number: 160961010

Project Name: Adelaide Wind Farm

Date Initiated: Sept. 14/2015

Field Personnel: Ken Edwards

Turbine No.: 17

Total Area: 7,854 m<sup>2</sup>

Total Surveyable Area: 7854

% VEGETATION COVER	VEGETATION HEIGHT	VISIBILITY CLASS
≥ 90% bare ground	≤ 15cm tall	Class 1 (Easy)
≥ 25% bare ground	≤ 15cm tall	Class 2 (Moderate)
≤ 25% bare ground	≤ 25% > 30cm tall	Class 3 (Difficult)
Little or no bare ground	≥ 25% > 30cm tall	Class 4 (Very difficult)

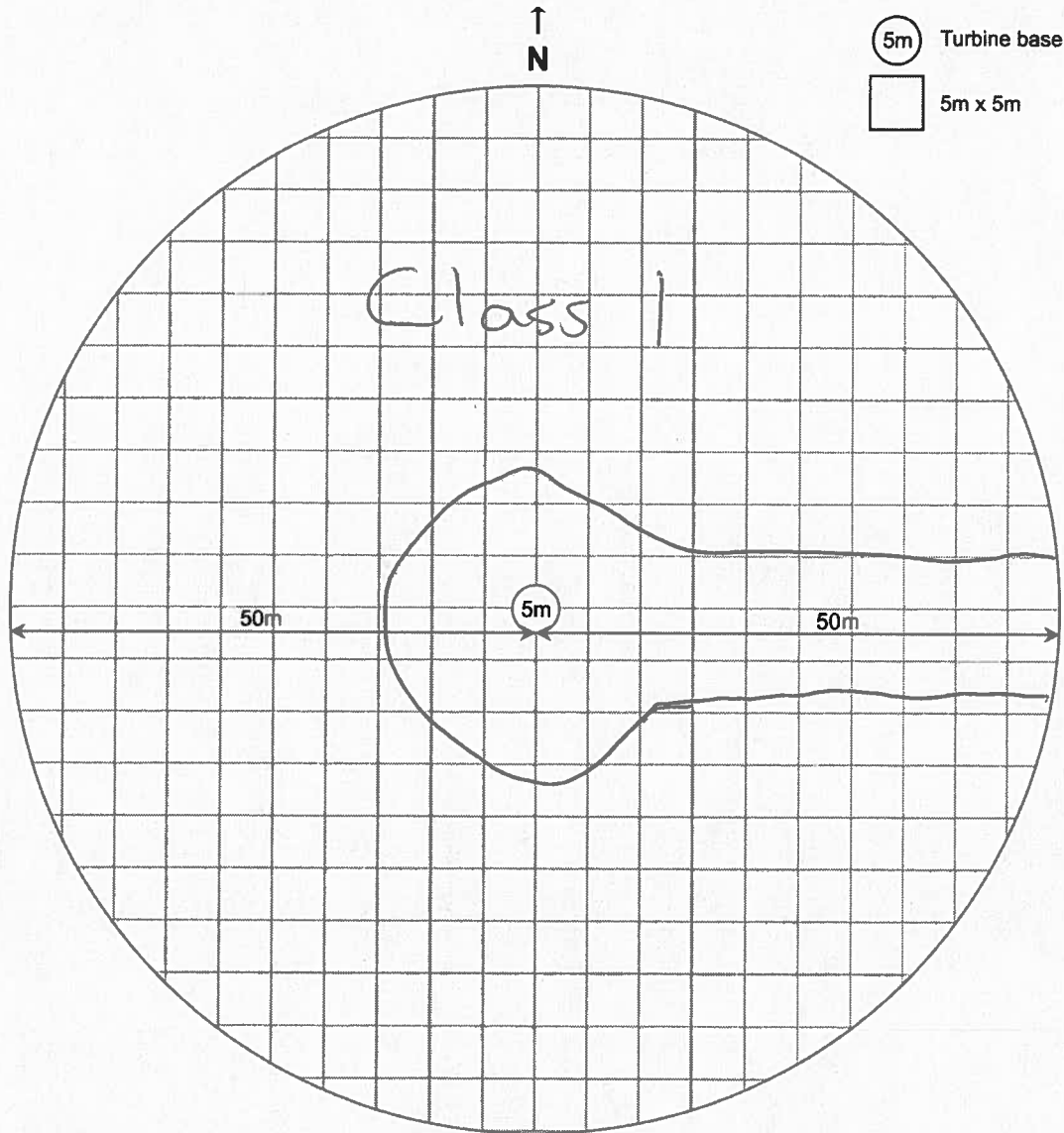

Project Number: 160961010

Project Name: Adelaide Wind Farm

Date Initiated: May 4/2015

Field Personnel: Ken Edwards

Turbine No.: 19

Total Area: 7,854 m<sup>2</sup>

Total Surveyable Area: 7854 m<sup>2</sup>

(64.28) shallow pond

% VEGETATION COVER	VEGETATION HEIGHT	VISIBILITY CLASS
≥ 90% bare ground	≤ 15cm tall	Class 1 (Easy)
≥ 25% bare ground	≤ 15cm tall	Class 2 (Moderate)
≤ 25% bare ground	≤ 25% > 30cm tall	Class 3 (Difficult)
Little or no bare ground	≥ 25% > 30cm tall	Class 4 (Very difficult)

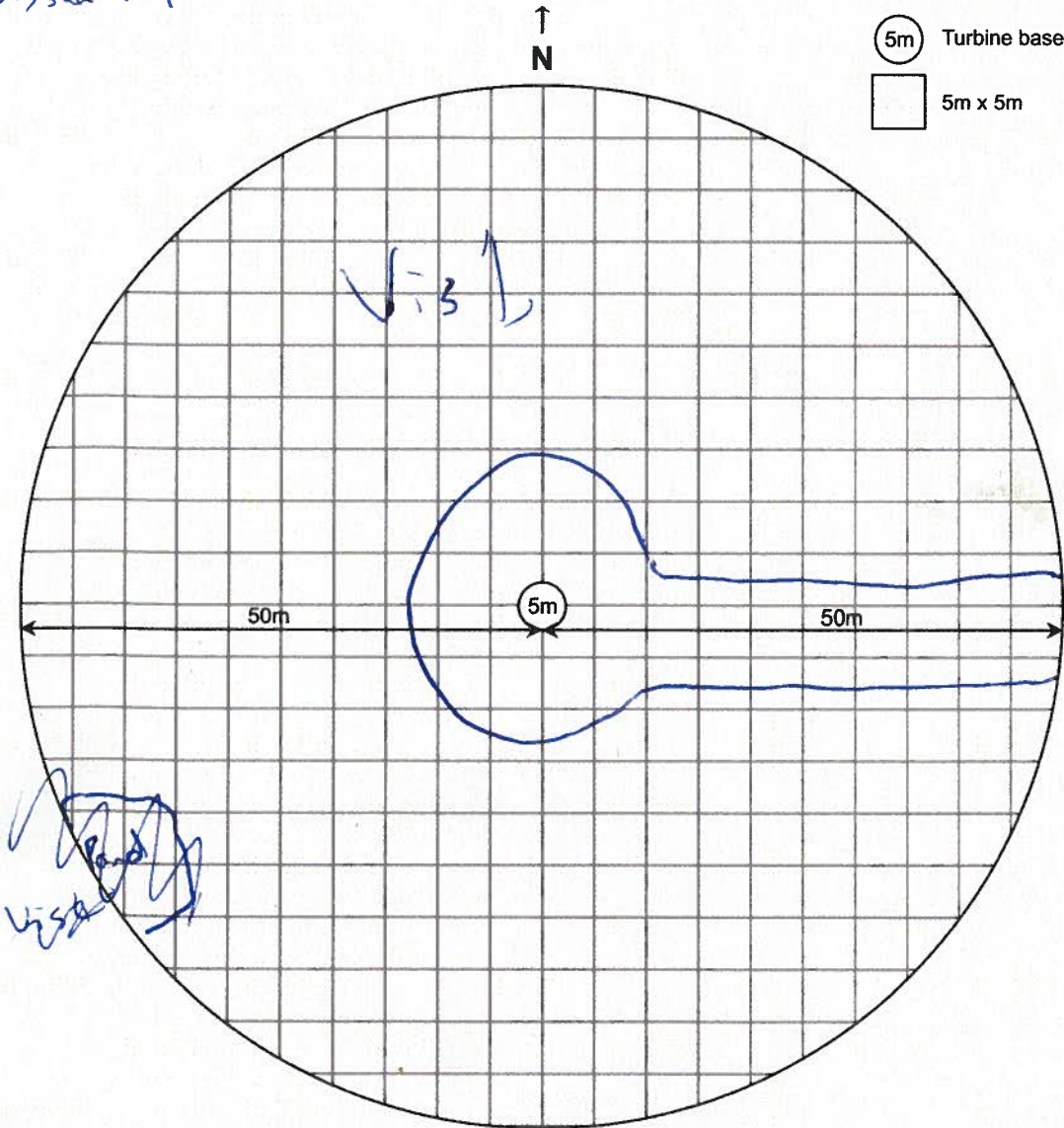

Project Number: 160961010  
Date Initiated: June 4, 2015

Project Name: Adelaide Wind Farm  
Field Personnel: Ken Edwards

Turbine No.: 19

Total Area: 7,854 m<sup>2</sup>

Total Surveyable Area: 7854

% VEGETATION COVER	VEGETATION HEIGHT	VISIBILITY CLASS
≥ 90% bare ground	≤ 15cm tall	Class 1 (Easy)
≥ 25% bare ground	≤ 15cm tall	Class 2 (Moderate)
≤ 25% bare ground	≤ 25% > 30cm tall	Class 3 (Difficult)
Little or no bare ground	≥ 25% > 30cm tall	Class 4 (Very difficult)

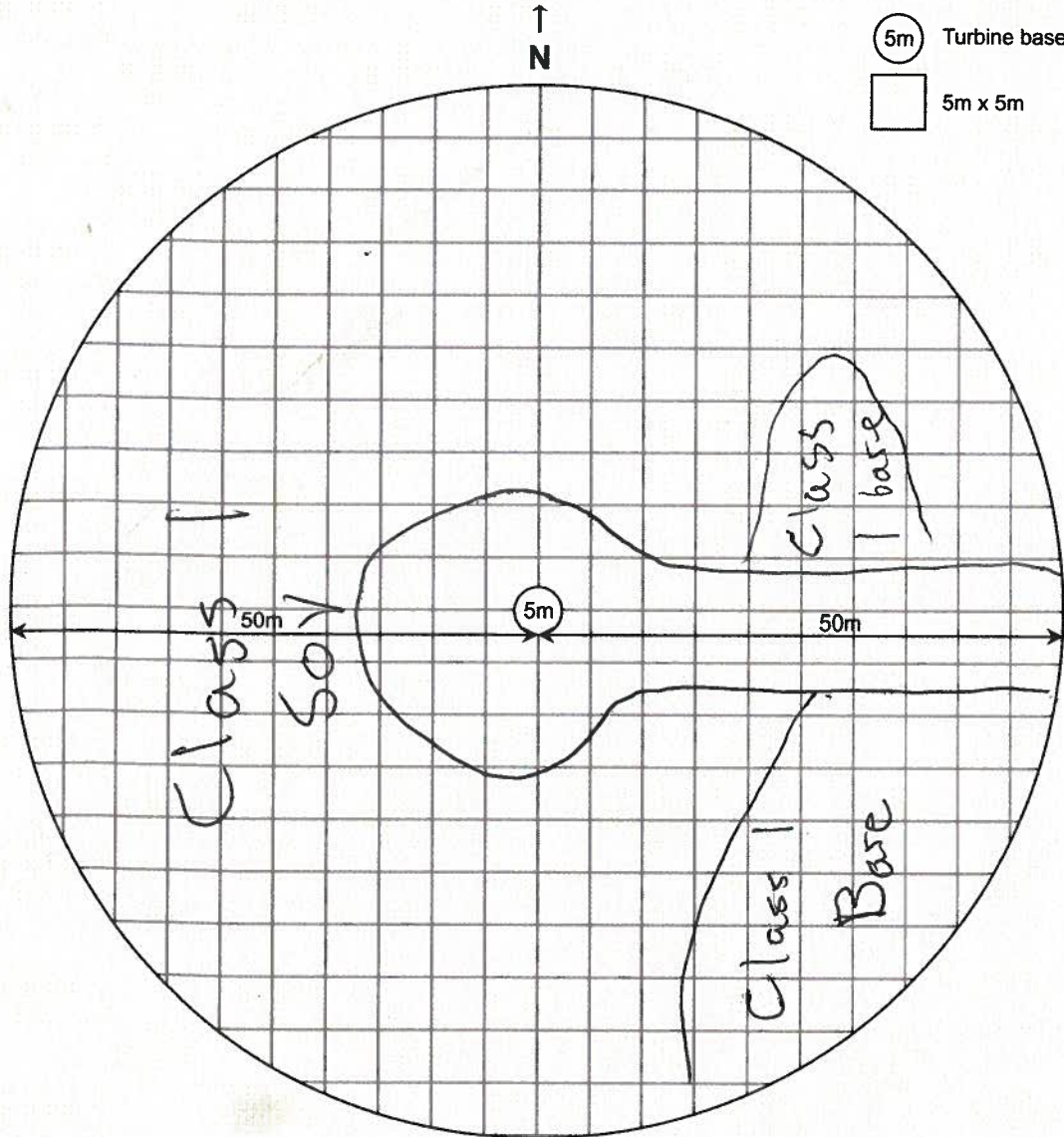

Project Number: 160961010

Project Name: Adelaide Wind Farm

Date Initiated: May 4/2015

Field Personnel: Ken Edwards

Turbine No.: 20

Total Area: 7,854 m<sup>2</sup>

Total Surveyable Area: 7854

% VEGETATION COVER	VEGETATION HEIGHT	VISIBILITY CLASS
≥ 90% bare ground	≤ 15cm tall	Class 1 (Easy)
≥ 25% bare ground	≤ 15cm tall	Class 2 (Moderate)
≤ 25% bare ground	≤ 25% > 30cm tall	Class 3 (Difficult)
Little or no bare ground	≥ 25% > 30cm tall	Class 4 (Very difficult)

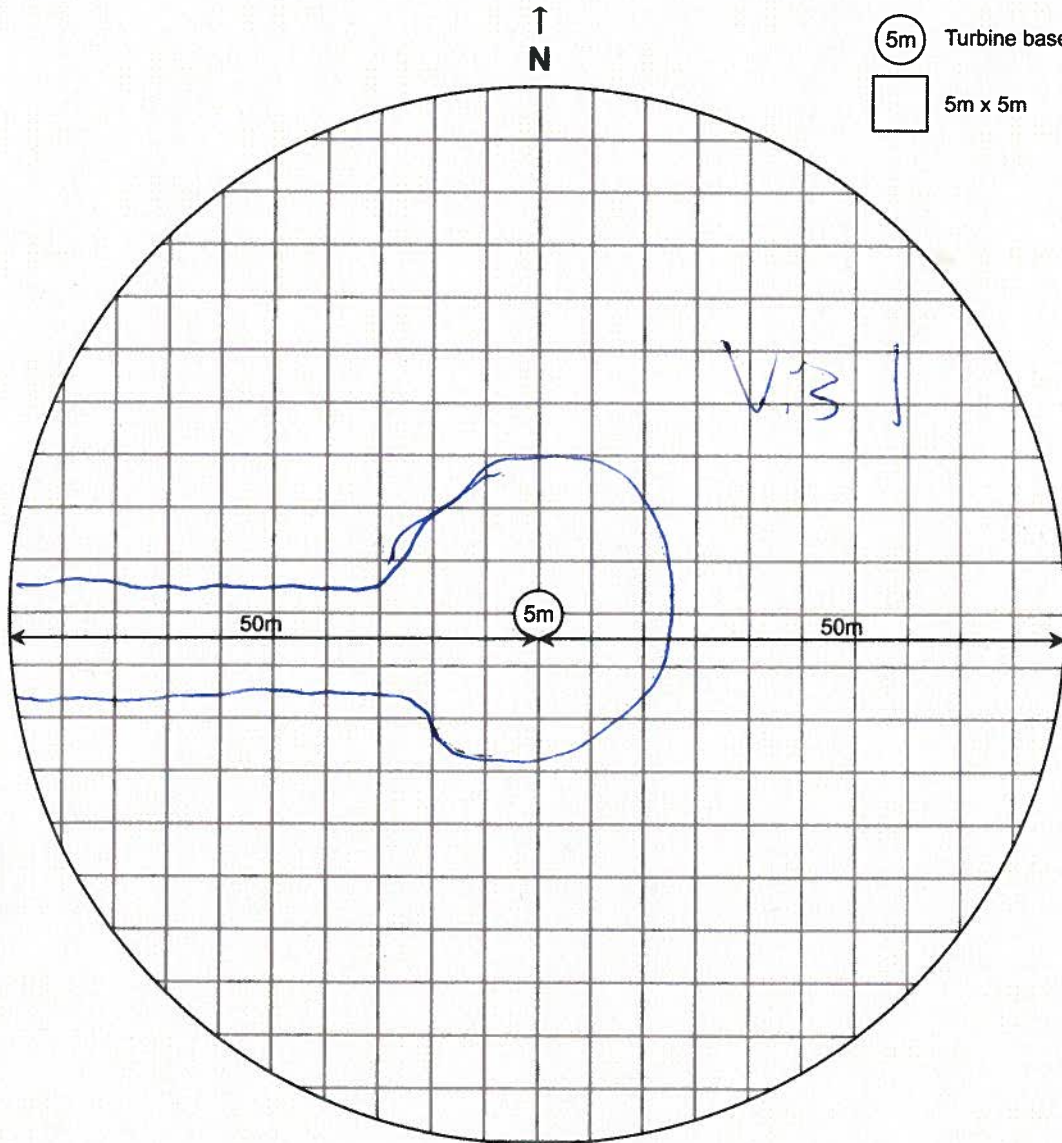



Project Number: 160961010

Project Name: Adelaide Wind Farm

Date Initiated: May 4/2015

Field Personnel: Ken Edwards

Turbine No.: 22

Total Area: 7,854 m<sup>2</sup>

Total Surveyable Area: 7854m<sup>2</sup>

% VEGETATION COVER	VEGETATION HEIGHT	VISIBILITY CLASS
≥ 90% bare ground	≤ 15cm tall	Class 1 (Easy)
≥ 25% bare ground	≤ 15cm tall	Class 2 (Moderate)
≤ 25% bare ground	≤ 25% > 30cm tall	Class 3 (Difficult)
Little or no bare ground	≥ 25% > 30cm tall	Class 4 (Very difficult)

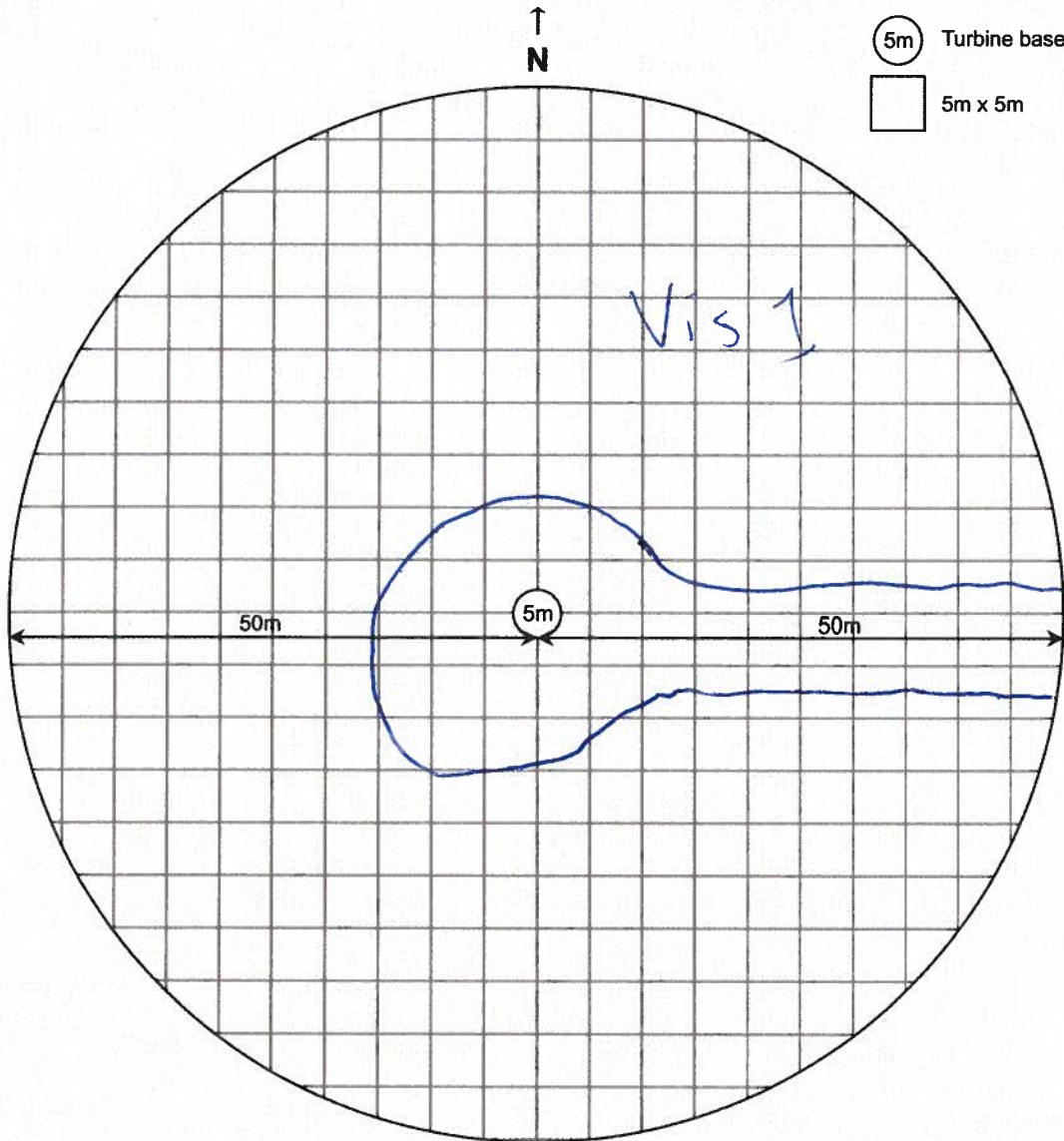

Project Number: 160961010

Project Name: Adelaide Wind Farm

Date Initiated: May 22/2015

Field Personnel: Ken Edwards

Turbine No.: 22

Total Area: 7,854 m<sup>2</sup>

Total Surveyable Area: 7854

% VEGETATION COVER	VEGETATION HEIGHT	VISIBILITY CLASS
≥ 90% bare ground	≤ 15cm tall	Class 1 (Easy)
≥ 25% bare ground	≤ 15cm tall	Class 2 (Moderate)
≤ 25% bare ground	≤ 25% > 30cm tall	Class 3 (Difficult)
Little or no bare ground	≥ 25% > 30cm tall	Class 4 (Very difficult)

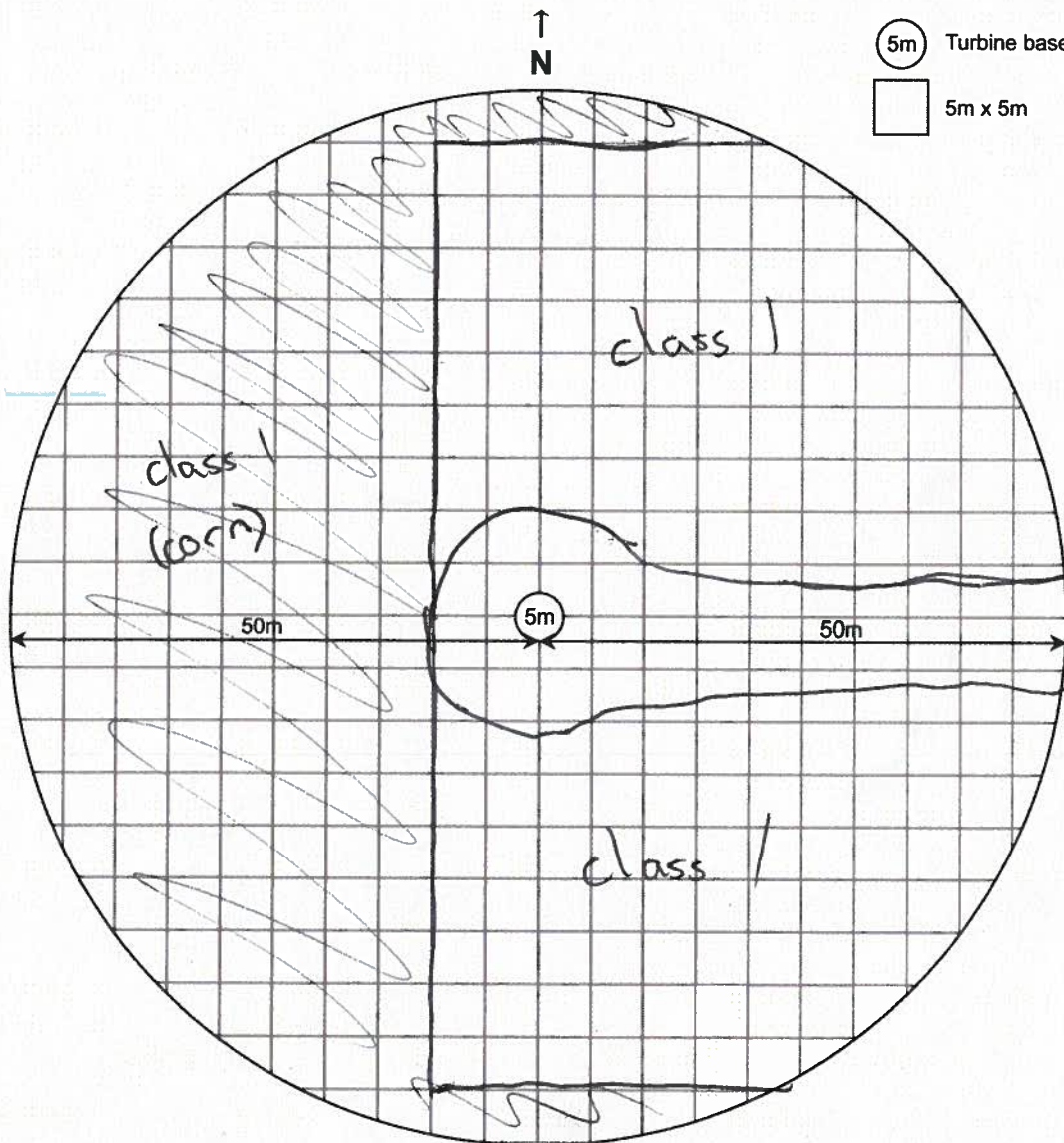

Project Number: 160961010

Project Name: Adelaide Wind Farm

Date Initiated: June 4, 2015

Field Personnel: Ken Edwards

Turbine No.: 28

Total Area: 7,854 m<sup>2</sup>

Total Surveyable Area: 7695

% VEGETATION COVER	VEGETATION HEIGHT	VISIBILITY CLASS
≥ 90% bare ground	≤ 15cm tall	Class 1 (Easy)
≥ 25% bare ground	≤ 15cm tall	Class 2 (Moderate)
≤ 25% bare ground	≤ 25% > 30cm tall	Class 3 (Difficult)
Little or no bare ground	≥ 25% > 30cm tall	Class 4 (Very difficult)

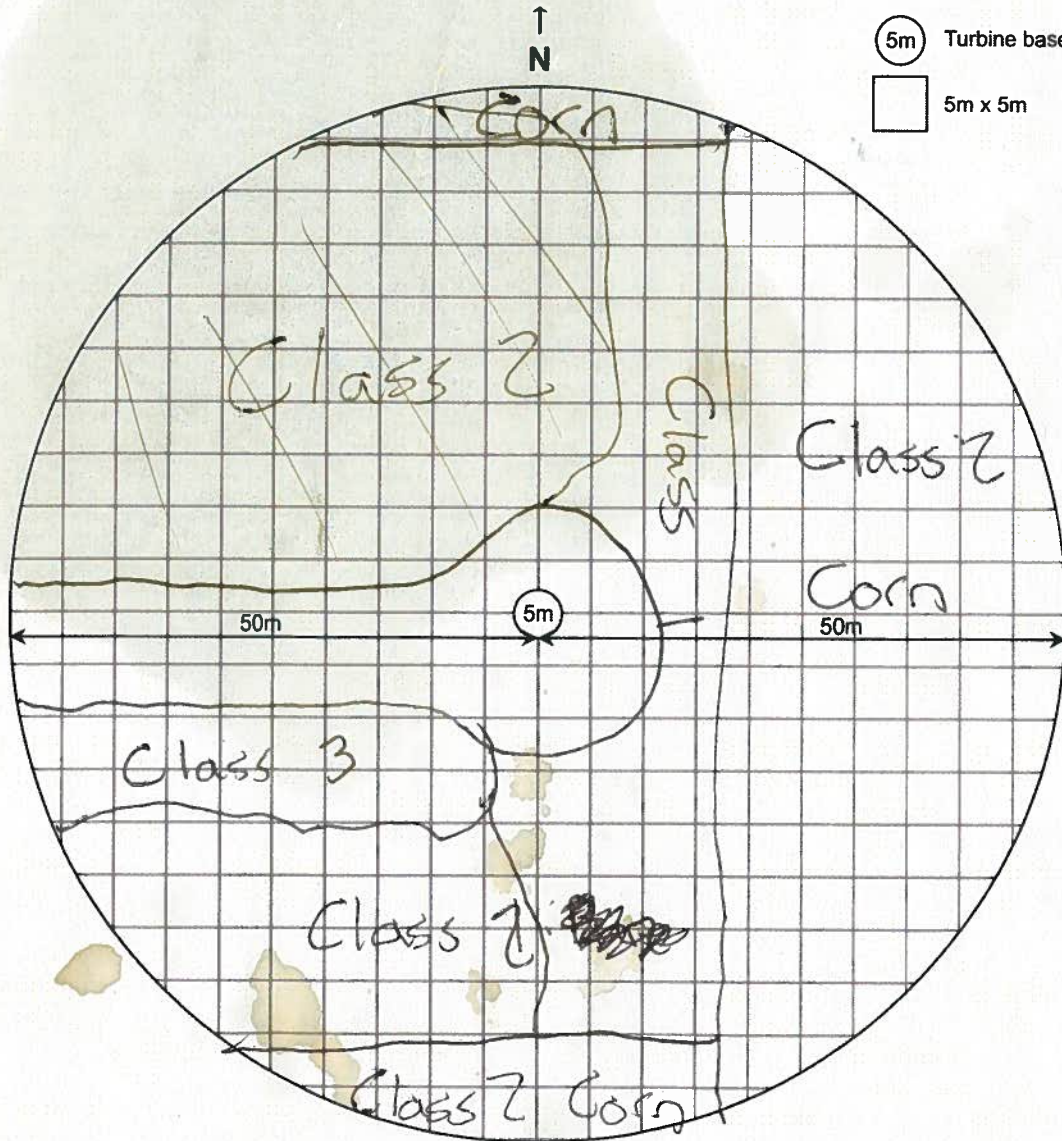

Project Number: 160961010

Project Name: Adelaide Wind Farm

Date Initiated: June 18/2015

Field Personnel: Ken Edwards

Turbine No.: 22

Total Area: 7,854 m<sup>2</sup>

Total Surveyable Area: 4701

% VEGETATION COVER	VEGETATION HEIGHT	VISIBILITY CLASS
≥ 90% bare ground	≤ 15cm tall	Class 1 (Easy)
≥ 25% bare ground	≤ 15cm tall	Class 2 (Moderate)
≤ 25% bare ground	≤ 25% > 30cm tall	Class 3 (Difficult)
Little or no bare ground	≥ 25% > 30cm tall	Class 4 (Very difficult)

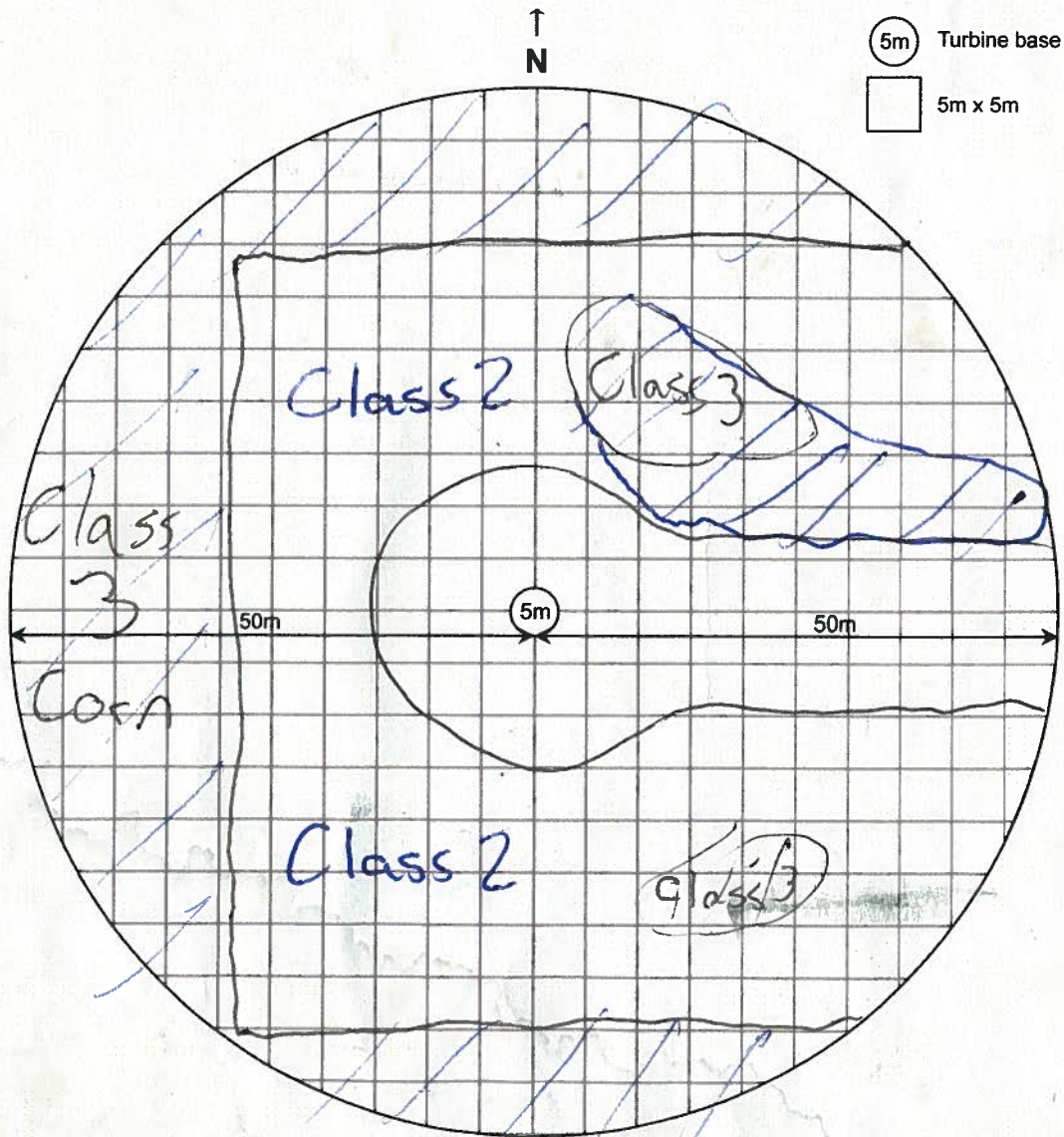

Project Number: 160961010

Project Name: Adelaide Wind Farm

Date Initiated: July 13 / 2015

Field Personnel: Ken Edwards

Turbine No.: 22

Total Area: 7,854 m<sup>2</sup>

Total Surveyable Area: 5268

% VEGETATION COVER	VEGETATION HEIGHT	VISIBILITY CLASS
≥ 90% bare ground	≤ 15cm tall	Class 1 (Easy)
≥ 25% bare ground	≤ 15cm tall	Class 2 (Moderate)
≤ 25% bare ground	≤ 25% > 30cm tall	Class 3 (Difficult)
Little or no bare ground	≥ 25% > 30cm tall	Class 4 (Very difficult)

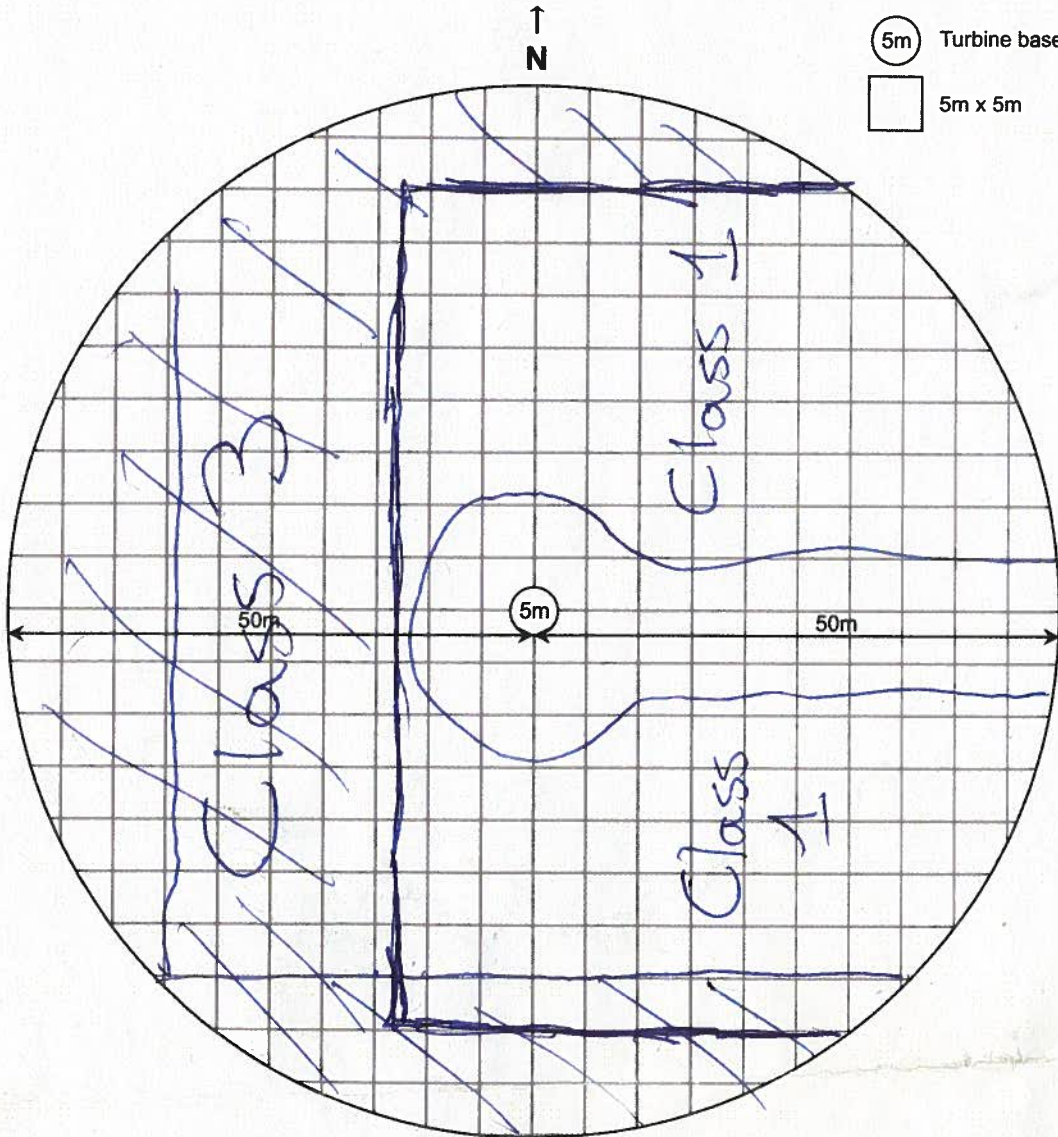

Project Number: 160961010

Project Name: Adelaide Wind Farm

Date Initiated: Oct 26/2015

Field Personnel: Ken Edwards

Turbine No.: 22

Total Area: 7,854 m<sup>2</sup>

Total Surveyable Area: 4257

% VEGETATION COVER	VEGETATION HEIGHT	VISIBILITY CLASS
≥ 90% bare ground	≤ 15cm tall	Class 1 (Easy)
≥ 25% bare ground	≤ 15cm tall	Class 2 (Moderate)
≤ 25% bare ground	≤ 25% > 30cm tall	Class 3 (Difficult)
Little or no bare ground	≥ 25% > 30cm tall	Class 4 (Very difficult)

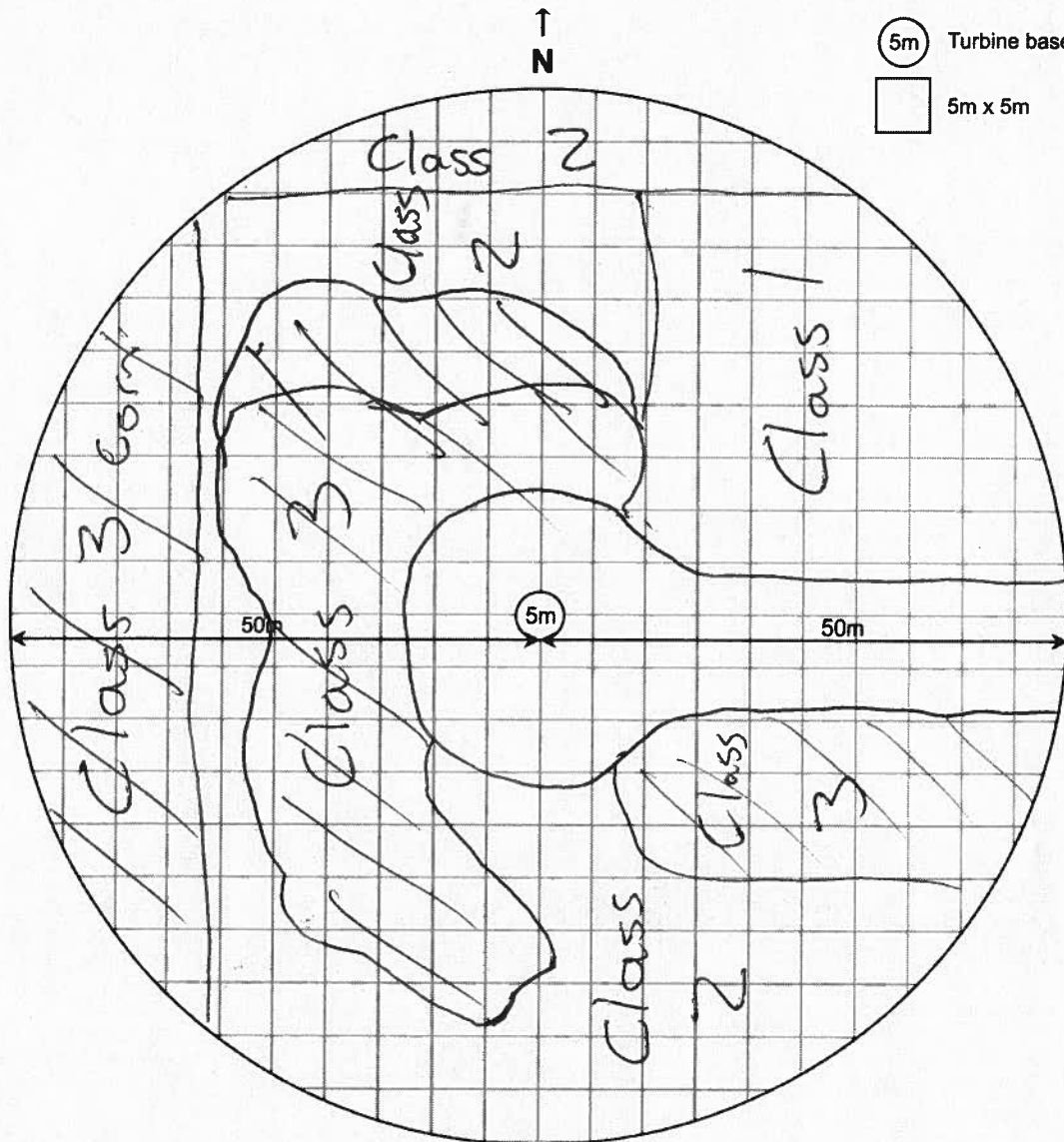

Project Number: 160961010

Project Name: Adelaide Wind Farm

Date Initiated: May 4 / 2015

Field Personnel: Ken Edwards

Turbine No.: 27

Total Area: 7,854 m<sup>2</sup>

Total Surveyable Area: 7,854 m<sup>2</sup>

% VEGETATION COVER	VEGETATION HEIGHT	VISIBILITY CLASS
≥ 90% bare ground	≤ 15cm tall	Class 1 (Easy)
≥ 25% bare ground	≤ 15cm tall	Class 2 (Moderate)
≤ 25% bare ground	≤ 25% > 30cm tall	Class 3 (Difficult)
Little or no bare ground	≥ 25% > 30cm tall	Class 4 (Very difficult)

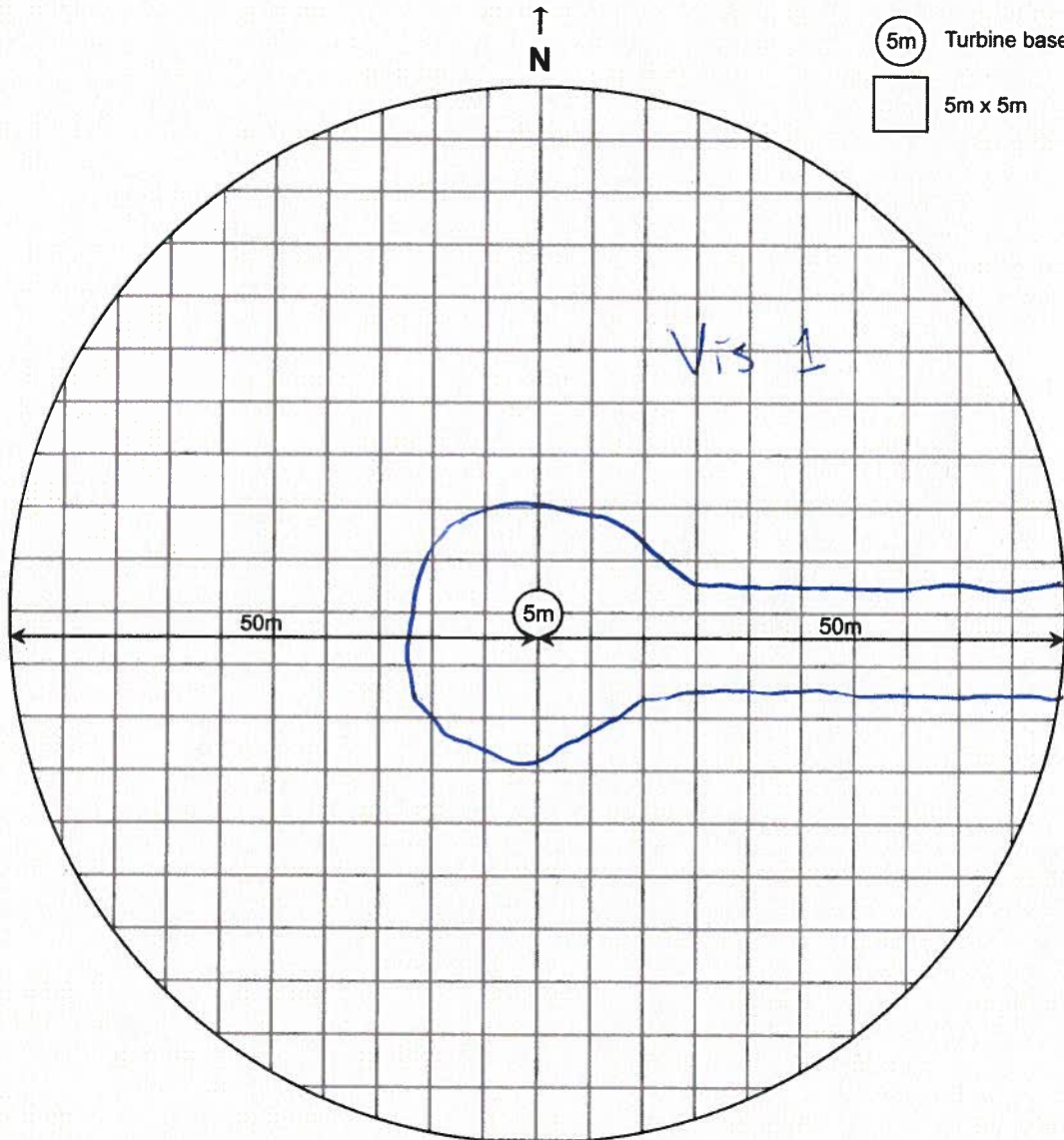

Project Number: 160961010  
Date Initiated: July 30, 2015

Project Name: Adelaide Wind Farm  
Field Personnel: Ken Edwards

Turbine No.: 27

Total Area: 7,854 m<sup>2</sup>

Total Surveyable Area: 7,432

% VEGETATION COVER	VEGETATION HEIGHT	VISIBILITY CLASS
≥ 90% bare ground	≤ 15cm tall	Class 1 (Easy)
≥ 25% bare ground	≤ 15cm tall	Class 2 (Moderate)
≤ 25% bare ground	≤ 25% > 30cm tall	Class 3 (Difficult)
Little or no bare ground	≥ 25% > 30cm tall	Class 4 (Very difficult)

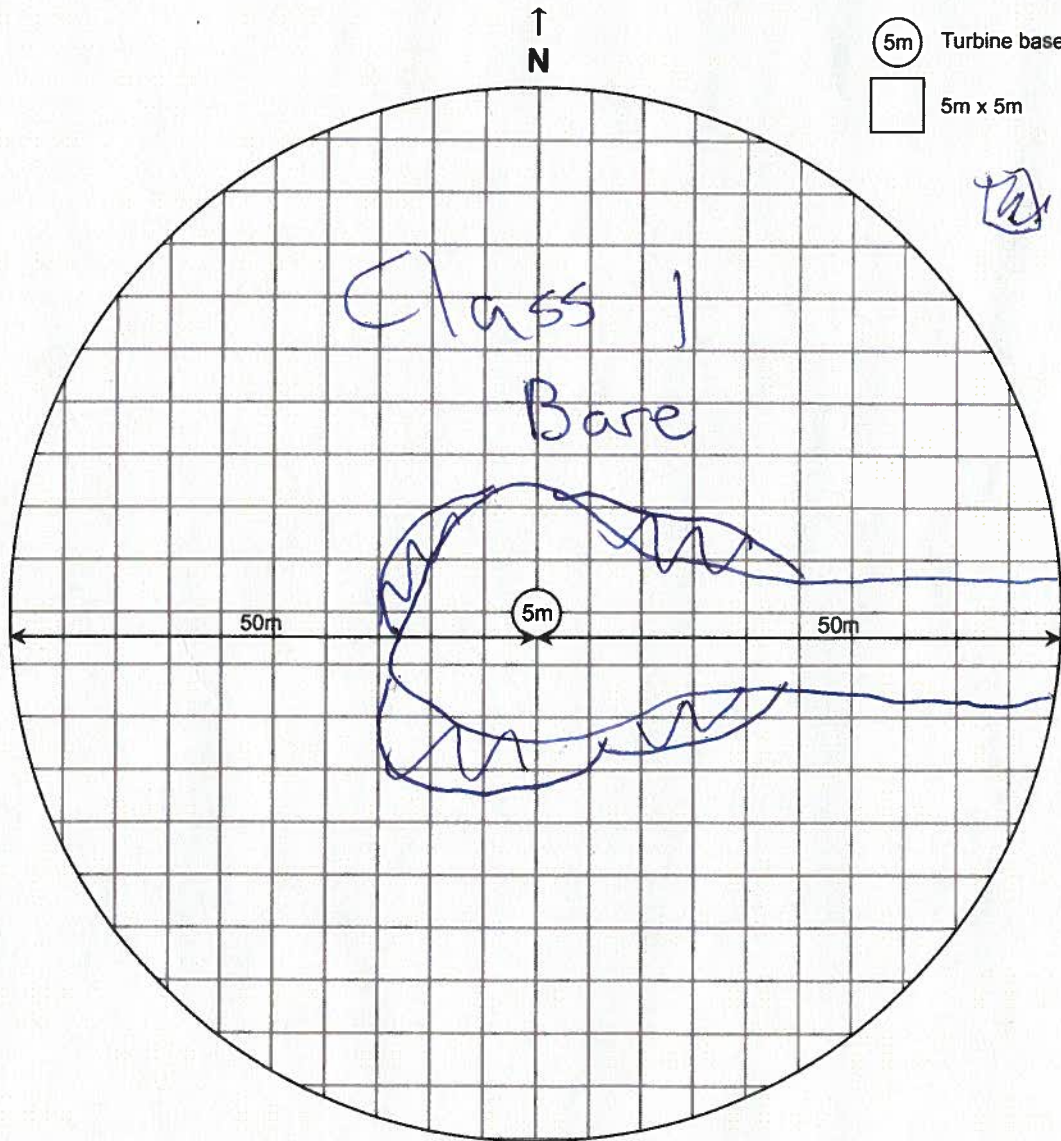





## Mortality Survey Observation Form

Project No: 160961010  
 Date: May 4/2015  
 Start/End Time: 8:40 / 4:45

Project Name: Adelaide Wind Farm  
 Personnel: Ken Edwards

Weather Conditions: 13-16 23km/h SW 90% No No  
 TEMP (°C) WIND CLOUD PPT PPT (last 24-hrs)  
 speed/direction

DECOMPOSITION CODES<sup>2</sup>:  
 Fresh Moderate Complete  
 Early Advanced Scavenged

% VEG. COVER	VEG. HEIGHT	VISIBILITY CLASS <sup>4</sup>
≥ 90% bare ground	≤ 15cm tall	Class 1 (Easy)
≥ 25% bare ground	≤ 15cm tall	Class 2 (Moderate)
≤ 25% bare ground	≤ 25% > 30cm tall	Class 3 (Difficult)
Little/no bare ground	≥ 25% > 30cm tall	Class 4 (Very difficult)

Turbine No.	Area (m <sup>2</sup> )	Start Time	End Time	Duration	Species	Sex (m/f/u)	Bat Forearm <sup>1</sup> (mm)	UTM Coordinates		Decomposition Code <sup>2</sup>	Est. Hours Since Death	Injury <sup>3</sup> Sustained	Distance from Turbine (m)	Direction from Turbine	Substrate	Visibility Class <sup>4</sup>	Photo #
								Zone	Eastings								
7	7854	8:40	9:10	40 min	—			E	N								
11	7854	9:20	10:05	45 min	—			E	N								
12	7854	10:15	11:00	45 min	—			E	N								
17	7854	11:15	11:50	35 min	—			E	N								
19	7854	12:00	12:30	30 min	—			E	N								
20	7854	12:55	1:30	35 min	—			E	N								
22	7854	1:40	2:20	40 min	—			E	N								
27	7854	2:30	3:15	45 min	—			E	N								
14	7854	3:30	4:00	30 min	—			E	N								
6	7854	4:10	4:45	35 min	—			E	N								
								E	N								
								E	N								

<sup>1</sup> See bat forearm diagram on reverse of page.

<sup>3</sup> INJURY TYPES: None Visible / Broken Limb / Broken Neck / Broken Wing / Cut in Half / Decapitated / Head Injury / Severed Wing / Wound to Abdomen

PAGE 1 OF 1

Print Name & Initial: Ken Edwards *KE*  
 (field notes author)

Quality Control: \_\_\_\_\_ This form is complete  & legible

Print Name & Initial: Anna Carrigan *AC*  
 (field notes QA/QC personnel)

### Mortality Survey Observation Form

Project No: 160961010 Project Name: Adelaide Wind Farm  
 Date: May 7/2015 Personnel: Ken Edwards  
 Start/End Time: 8:30 / 16:00  
 Weather Conditions: 16-26 10km/h / SE 20% No No  
 TEMP (°C) WIND CLOUD PPT PPT (last 24-hrs)

DECOMPOSITION CODES<sup>2</sup>:  
 Fresh Moderate Complete  
 Early Advanced Scavenged

% VEG. COVER	VEG. HEIGHT	VISIBILITY CLASS <sup>4</sup>
≥ 90% bare ground	≤ 15cm tall	Class 1 (Easy)
≥ 25% bare ground	≤ 15cm tall	Class 2 (Moderate)
≤ 25% bare ground	≤ 25% > 30cm tall	Class 3 (Difficult)
Little/no bare ground	≥ 25% > 30cm tall	Class 4 (Very difficult)

Turbine No.	Area (m <sup>2</sup> )	Start Time	End Time	Duration	Species	Sex (m/f/u)	Bat Forearm <sup>1</sup> (mm)	UTM Coordinates		Decomposition Code <sup>2</sup>	Est. Hours Since Death	Injury <sup>3</sup> Sustained	Distance from Turbine (m)	Direction from Turbine	Substrate	Visibility Class <sup>4</sup>	Photo #
								Zone	Easting								
7	7854	8:30	9:10	40min	—			E	N								
12	7854	9:30	10:10	40min	—			E	N								
14	7854	10:20	10:55	35min	—			E	N								
17	7854	11:05	11:35	30min	med bird			E	N	TEST CARCASS			45m	NNE ground	2	✓	
19	7854	11:45	12:15	30min	—			E	N								
20	7854	12:25	12:55	30min	—			E	N								
22	7854	13:05	13:45	40min	small bird			E	N	TEST CARCASS			21m	SW ground	1	✓	
26	7854	14:00	14:30	30min	—			E	N								
11	7854	14:40	15:15	35min	—			E	N								
6	7854	15:25	15:55	30min	red bat			E	N	TEST CARCASS			5m	NW gravel	1	✓	
								E	N								

<sup>1</sup> See bat forearm diagram on reverse of page.

<sup>3</sup> INJURY TYPES: None Visible / Broken Limb / Broken Neck / Broken Wing / Cut in Half / Decapitated / Head Injury / Severed Wing / Wound to Abdomen

PAGE 1 OF 1

Print Name & Initial: Ken Edwards KE

(field notes author)

Quality Control:

Print Name & Initial: Anna Cormican AC

(field notes QA/QC personnel)

This form is complete  & legible

**Mortality Survey  
Observation Form**

Project No: 160961010 Project Name: Adelaide Wind Farm  
 Date: May 11, 2015 Personnel: Ken Edwards  
 Start/End Time: 8:30 / 16:05

Weather Conditions: 16-29 18 km/h S 100% No Light  
 TEMP (°C) WIND CLOUD PPT PPT (last 24-hrs)  
 speed/direction - 50%

DECOMPOSITION CODES:  
 Fresh Moderate Complete  
 Early Advanced Scavenged

% VEG. COVER	VEG. HEIGHT	VISIBILITY CLASS <sup>4</sup>
≥ 90% bare ground	≤ 15cm tall	Class 1 (Easy)
≥ 25% bare ground	≤ 15cm tall	Class 2 (Moderate)
≤ 25% bare ground	≤ 25% > 30cm tall	Class 3 (Difficult)
Little/no bare ground	≥ 25% > 30cm tall	Class 4 (Very difficult)

Turbine No.	Area (m <sup>2</sup> )	Start Time	End Time	Duration	Species	Sex (m/f/u)	Bat Forearm <sup>1</sup> (mm)	UTM Coordinates		Decomposition Code <sup>2</sup>	Est. Hours Since Death	Injury <sup>3</sup> Sustained	Distance from Turbine (m)	Direction from Turbine	Substrate	Visibility Class <sup>4</sup>	Photo #
								Zone	Easting								
6	7854	8:40	9:15	35 min	—			E	N								
7	7854	4:25	10:00	35 min	—			E	N								
11	7854	10:20	11:00	40 min	—			E	N								
12	7854	11:10	11:45	35 min	—			E	N								
14	7854	11:50	12:20	30 min	—			E	N								
17	7854	12:30	13:10	40 min	—			E	N								
19	7854	13:20	14:00	40 min	—			E	N								
20	7854	14:15	14:50	35 min	—			E	N								
22	7854	14:55	15:25	30 min	—			E	N								
27	7854	15:35	16:05	30 min	—			E	N								
								E	N								
								E	N								

<sup>1</sup> See bat forearm diagram on reverse of page.

<sup>3</sup> INJURY TYPES: None Visible / Broken Limb / Broken Neck / Broken Wing / Cut in Half / Decapitated / Head Injury / Severed Wing / Wound to Abdomen

PAGE 1 OF 1  
 Print Name & Initial: Ken Edwards  
 (field notes author)

Quality Control: Anna Carrigan  
 Print Name & Initial: Anna Carrigan  
 (field notes QA/QC personnel)

This form is complete  & legible

**Mortality Survey  
Observation Form**

Project No: 160961010  
 Date: May 14/2015  
 Start/End Time: 8:30 14:20

Project Name: Adelaide Wind Farm  
 Personnel: Ken Edwards

Weather Conditions: 8-20 6km/h / E 0% no no  
 TEMP (°C) WIND CLOUD PPT PPT (last 24-hrs)  
 speed/direction

DECOMPOSITION CODES<sup>2</sup>:  
 Fresh Moderate Complete  
 Early Advanced Scavenged

% VEG. COVER	VEG. HEIGHT	VISIBILITY CLASS <sup>4</sup>
≥ 90% bare ground	≤ 15cm tall	Class 1 (Easy)
≥ 25% bare ground	≤ 15cm tall	Class 2 (Moderate)
≤ 25% bare ground	≤ 25% > 30cm tall	Class 3 (Difficult)
Little/no bare ground	≥ 25% > 30cm tall	Class 4 (Very difficult)

Turbine No.	Area (m <sup>2</sup> )	Start Time	End Time	Duration	Species	Sex (m/f/u)	Bat Forearm <sup>1</sup> (mm)	UTM Coordinates		Decomposition Code <sup>2</sup>	Est. Hours Since Death	Injury <sup>3</sup> Sustained	Distance from Turbine (m)	Direction from Turbine	Substrate	Visibility Class <sup>4</sup>	Photo #
								Zone	Easting								
6	7854	8:48	9:23	40min	—			E	N								
7	"	9:30	10:00	30min	—			E	N								
12	"	10:15	10:50	35min	—			E	N								
14	"	11:00	11:40	40min	large bat	/	/	17T	E <sup>044</sup> 7189	N 476 4862	-TEST CARCASS-16		SE ground		/	/	
17	"	11:50	12:20	30min	—			E	N								
20	"	12:50	13:25	35min	—			E	N								
<del>22</del>	"	13:35	14:10	35min	—			E	N								
27	"	14:20	15:00	40min	—			E	N								
19	"	maintenance						E	N								
11	"	maintenance						E	N								
								E	N								
								E	N								

<sup>1</sup> See bat forearm diagram on reverse of page.

<sup>3</sup> INJURY TYPES: None Visible / Broken Limb / Broken Neck / Broken Wing / Cut in Half / Decapitated / Head Injury / Severed Wing / Wound to Abdomen



# Mortality Survey Observation Form

Project No: 160961010

Project Name: Adelaishe Wind Farm

Date: May 19 2015

Personnel: Ken Edwards

Start/End Time: 8:40 116:10

Weather Conditions: 14° 19 km/h 1WNW 40% no no  
 TEMP (°C) WIND speed/direction CLOUD PPT PPT (last 24-hrs)

**DECOMPOSITION CODES:**

Fresh Moderate Complete  
 Early Advanced Scavenged

% VEG. COVER	VEG. HEIGHT	VISIBILITY CLASS <sup>4</sup>
≥ 90% bare ground	≤ 15cm tall	Class 1 (Easy)
≥ 25% bare ground	≤ 15cm tall	Class 2 (Moderate)
≤ 25% bare ground	≤ 25% > 30cm tall	Class 3 (Difficult)
Little/no bare ground	≥ 25% > 30cm tall	Class 4 (Very difficult)

Turbine No.	Area (m <sup>2</sup> )	Start Time	End Time	Duration	Species	Sex (m/f/u)	Bat Forearm <sup>1</sup> (mm)	UTM Coordinates		Decomposition Code <sup>2</sup>	Est. Hours Since Death	Injury <sup>3</sup> Sustained	Distance from Turbine (m)	Direction from Turbine	Substrate	Visibility Class <sup>4</sup>	Photo #
								Zohe	Eastings								
6	7854	8:40	9:20	40 min	—			E	N								
7	7854	9:30	10:05	35 min	—			E	N								
11	7854	10:15	10:45	30 min	—			E	N								
12	7854	11:00	11:35	35 min	—			E	N								
14	7854	11:45	12:20	35 min	—			E	N								
17	7854	12:35	13:05	30 min	—			E	N								
20	7854	13:15	13:55	40 min	—			E	N								
22	7854	14:05	14:35	30 min	—			E	N								
27	7854	14:50	15:25	35 min	—			E	N								
19	7854	15:35	16:10	35 min	—			E	N								
								E	N								

<sup>1</sup> See bat forearm diagram on reverse of page.

<sup>3</sup> INJURY TYPES: None Visible / Broken Limb / Broken Neck / Broken Wing / Cut in Half / Decapitated / Head Injury / Severed Wing / Wound to Abdomen

PAGE 1 OF 1

Print Name & Initial: Ken Edwards KE  
 (field notes author)

Quality Control: Anna Carrigan AC This form is complete  & legible

Print Name & Initial: Anna Carrigan AC  
 (field notes QA/QC personnel)

### Mortality Survey Observation Form

 Project No: 160961010

 Project Name: Adelaide Wind Farm

 Date: May 22/2015

 Personnel: Ken Edwards

 Start/End Time: 8:30 16:30

 Weather Conditions: 6-13 16km/h NNW  
 TEMP (°C) WIND speed/direction

0% no no  
 CLOUD PPT PPT (last 24-hrs)

 DECOMPOSITION CODES:  
 Fresh Moderate Complete  
 Early Advanced Scavenged

% VEG. COVER	VEG. HEIGHT	VISIBILITY CLASS <sup>4</sup>
≥ 90% bare ground	≤ 15cm tall	Class 1 (Easy)
≥ 25% bare ground	≤ 15cm tall	Class 2 (Moderate)
≤ 25% bare ground	≤ 25% > 30cm tall	Class 3 (Difficult)
Little/no bare ground	≥ 25% > 30cm tall	Class 4 (Very difficult)

Turbine No.	Area (m <sup>2</sup> )	Start Time	End Time	Duration	Species	Sex (m/f/u)	Bat Forearm <sup>1</sup> (mm)	UTM Coordinates			Decomposition Code <sup>2</sup>	Est. Hours Since Death	Injury <sup>3</sup> Sustained	Distance from Turbine (m)	Direction from Turbine	Substrate	Visibility Class <sup>4</sup>	Photo #
								Zone	Easting	Northing								
6	7854	8:45	9:20	35min	-			E	N									
7	7854	9:30	10:05	35min	-			E	N									
11	7854	10:15	10:45	30min	-			E	N									
12	7854	10:55	11:30	35min	-			E	N									
14	7854	11:50	12:25	35min	-			E	N									
17	7854	12:35	13:10	35min	-			E	N									
20	7854	13:20	13:55	35min	-			E	N									
22	7854	14:05	14:45	40min	-			E	N									
27	7854	15:00	15:40	40min	-			E	N									
19	7854	15:55	16:25	30min	-			E	N									
								E	N									
								E	N									

<sup>1</sup> See bat forearm diagram on reverse of page.

<sup>3</sup> INJURY TYPES: None Visible / Broken Limb / Broken Neck / Broken Wing / Cut in Half / Decapitated / Head Injury / Severed Wing / Wound to Abdomen

 PAGE 1 OF 1

 Print Name & Initial: Ken Edwards  
 (field notes author)

Quality Control:

 Print Name & Initial: Anna Corrigan  
 (field notes QA/QC personnel)

 This form is complete  & legible

### Mortality Survey Observation Form

Project No: 160961010 Project Name: Adelaide Wind Farm

Date: May 23/2015 Personnel: Ken Edwards

Start/End Time: 8:40 16:25

Weather Conditions: 18 18km/h SE 100% no no  
 TEMP (°C) WIND CLOUD PPT PPT (last 24-hrs)  
 speed/direction

DECOMPOSITION CODES:  
 Fresh Moderate Complete  
 Early Advanced Scavenged

% VEG. COVER	VEG. HEIGHT	VISIBILITY CLASS <sup>4</sup>
≥ 90% bare ground	≤ 15cm tall	Class 1 (Easy)
≥ 25% bare ground	≤ 15cm tall	Class 2 (Moderate)
≤ 25% bare ground	≤ 25% > 30cm tall	Class 3 (Difficult)
Little/no bare ground	≥ 25% > 30cm tall	Class 4 (Very difficult)

Turbine No.	Area (m <sup>2</sup> )	Start Time	End Time	Duration	Species	Sex (m/f/u)	Bat Forearm <sup>1</sup> (mm)	UTM Coordinates		Decomposition Code <sup>2</sup>	Est. Hours Since Death	Injury <sup>3</sup> Sustained	Distance from Turbine (m)	Direction from Turbine	Substrate	Visibility Class <sup>4</sup>	Photo #
								Zone	Easting								
6	7854	8:40	9:15	35min	—			E	N								
7	7854	9:25	9:55	30min	—			E	N								
11	7854	10:05	10:40	35min	—			E	N								
12	7854	11:00	11:40	40min	—			E	N								
14	7854	11:50	12:20	30min	—			E	N								
17	7854	12:30	13:05	35min	—			E	N								
22	7854	13:20	14:00	40min	—			E	N								
27	7854	14:15	14:55	40min	—			E	N								
20	7854	15:10	15:40	30min	—			E	N								
19	7854	15:45	16:20	35min	—			E	N								
								E	N								
								E	N								

<sup>1</sup> See bat forearm diagram on reverse of page.

<sup>3</sup> INJURY TYPES: None Visible / Broken Limb / Broken Neck / Broken Wing / Cut in Half / Decapitated / Head Injury / Severed Wing / Wound to Abdomen

PAGE 1 OF 1  
 Print Name & Initial: Ken Edwards KE  
 (field notes author)

Quality Control: Anna Corman AC  
 Print Name & Initial: Anna Corman AC  
 (field notes QA/QC personnel)

This form is complete  & legible

### Mortality Survey Observation Form

Project No: 160961010 Project Name: Adelaide Wind Farm  
 Date: May 28/2015 Personnel: Ken Edwards  
 Start/End Time: 8:35 / 17:10

Weather Conditions: 16-22 10km/h / NNW 0% no yes  
 TEMP (°C) WIND speed/direction CLOUD PPT PPT (last 24-hrs)

DECOMPOSITION CODES<sup>2</sup>:  
 Fresh Moderate Complete  
 Early Advanced Scavenged

% VEG. COVER	VEG. HEIGHT	VISIBILITY CLASS <sup>4</sup>
≥ 90% bare ground	≤ 15cm tall	Class 1 (Easy)
≥ 25% bare ground	≤ 15cm tall	Class 2 (Moderate)
≤ 25% bare ground	≤ 25% > 30cm tall	Class 3 (Difficult)
Little/no bare ground	≥ 25% > 30cm tall	Class 4 (Very difficult)

Turbine No.	Area (m <sup>2</sup> )	Start Time	End Time	Duration	Species	Sex (m/f/u)	Bat Forearm <sup>1</sup> (mm)	UTM Coordinates		Decomposition Code <sup>2</sup>	Est. Hours Since Death	Injury <sup>3</sup> Sustained	Distance from Turbine (m)	Direction from Turbine	Substrate	Visibility Class <sup>4</sup>	Photo #
								Zone	Easting								
6	7854	8:35	9:15	40min	—			E	N								
7	"	9:25	10:10	45min	—			E	N								
11	"	10:20	11:05	45min	med. bird	/	/	17T	E 044 9078	N 475 946C	-TESTER CARCASS	45	E	ground	1	/	
12	"	11:15	12:00	45min	—			E	N								
14	"	12:10	12:50	40min	—			E	N								
17	3992	13:15	13:45	30min	—			E	N								
19	7854	13:35	14:35	40min	Silver Gnat	/	/	17T	E 044 2948	N 476 4963	-TESTER CARCASS	3	S	ground	1	/	
20	"	14:45	15:25	40min	—			E	N								
22	"	15:35	16:20	45min	—			E	N								
27	"	16:25	17:10	45min	—			E	N								
								E	N								
								E	N								

<sup>1</sup> See bat forearm diagram on reverse of page.  
<sup>3</sup> INJURY TYPES: None Visible / Broken Limb / Broken Neck / Broken Wing / Cut in Half / Decapitated / Head Injury / Severed Wing / Wound to Abdomen

PAGE 1 OF 1  
 Print Name & Initial: Ken Edwards KE  
 (field notes author)

Quality Control: \_\_\_\_\_ This form is complete  & legible   
 Print Name & Initial: Anna Corrigan  
 (field notes QA/QC personnel)



### Mortality Survey Observation Form

Project No: 160961010  
 Date: June 1/2015  
 Start/End Time: 8:30 / 17:30

Project Name: Adelaide Wind Farm  
 Personnel: Ken Edwards

Weather Conditions: 15-20 K/h / NE 30% no yes  
 TEMP (°C) WIND CLOUD PPT PPT (last 24-hrs)  
 speed/direction

DECOMPOSITION CODES<sup>2</sup>:  
 Fresh Moderate Complete  
 Early Advanced Scavenged

% VEG. COVER	VEG. HEIGHT	VISIBILITY CLASS <sup>4</sup>
≥ 90% bare ground	≤ 15cm tall	Class 1 (Easy)
≥ 25% bare ground	≤ 15cm tall	Class 2 (Moderate)
≤ 25% bare ground	≤ 25% > 30cm tall	Class 3 (Difficult)
Little/no bare ground	≥ 25% > 30cm tall	Class 4 (Very difficult)

Turbine No.	Area (m <sup>2</sup> )	Start Time	End Time	Duration	Species	Sex (m/f/u)	Bat Forearm <sup>1</sup> (mm)	UTM Coordinates		Decomposition Code <sup>2</sup>	Est. Hours Since Death	Injury <sup>3</sup> Sustained	Distance from Turbine (m)	Direction from Turbine	Substrate	Visibility Class <sup>4</sup>	Photo #
								Zone	Easting								
6	7854	9:40	9:25	45 min	Small bird	/	/	17T	E 045 1989	N 476 2610	-TESTER CARCASS	-5	NE	grass/ground	2	/	
11	7854	9:35	10:15	40 min	—			E	N								
14	7854	10:25	11:10	45 min	—			E	N								
17	3992	11:20	12:55	35 min	—			E	N								
19	7854	12:05	12:45	40 min	—			E	N								
20	7854	12:55	13:35	40 min	—			E	N								
22	7854	13:45	14:25	40 min	—			E	N								
27	7854	14:35	15:25	50 min	—			E	N								
12	7854	15:45	16:20	35 min	—			E	N								
7	6318	16:40	17:25	45 min	—			E	N								
								E	N								

<sup>1</sup> See bat forearm diagram on reverse of page.

<sup>3</sup> INJURY TYPES: None Visible / Broken Limb / Broken Neck / Broken Wing / Cut in Half / Decapitated / Head Injury / Severed Wing / Wound to Abdomen

PAGE 1 OF 1

Print Name & Initial: Ken Edwards KE  
 (field notes author)

Quality Control: Anna Corrigan AC  
 Print Name & Initial: Anna Corrigan AC  
 (field notes QA/QC personnel)

This form is complete  & legible

### Mortality Survey Observation Form

Project No: 160961010  
 Date: June 4, 2015  
 Start/End Time: 8:40 19:35

Project Name: Adelaide Wind Farm  
 Personnel: Ken Edwards

Weather Conditions: 16.28 13 km/h SSE 40% AD NO  
 TEMP (°C) WIND speed/direction CLOUD PPT PPT (last 24-hrs)

DECOMPOSITION CODES<sup>2</sup>:  
 Fresh  Moderate  Complete   
 Early  Advanced  Scavenged

% VEG. COVER	VEG. HEIGHT	VISIBILITY CLASS <sup>4</sup>
≥ 90% bare ground	≤ 15cm tall	Class 1 (Easy)
≥ 25% bare ground	≤ 15cm tall	Class 2 (Moderate)
≤ 25% bare ground	≤ 25% > 30cm tall	Class 3 (Difficult)
Little/no bare ground	≥ 25% > 30cm tall	Class 4 (Very difficult)

Turbine No.	Area (m <sup>2</sup> )	Start Time	End Time	Duration	Species	Sex (m/f/u)	Bat Forearm <sup>1</sup> (mm)	UTM Coordinates		Decomposition Code <sup>2</sup>	Est. Hours Since Death	Injury <sup>3</sup> Sustained	Distance from Turbine (m)	Direction from Turbine	Substrate	Visibility Class <sup>4</sup>	Photo #
								Zone	Easting								
6	4347	9:00	9:45	45 min	—			E	N								
7	6939	10:00	10:40	40 min	—			E	N								
11	7854	12:10	12:55	35 min	—			E	N								
12	7854	13:15	13:55	40 min	—			E	N								
14	7854	14:05	14:45	40 min	—			E	N								
17	3992	15:00	15:35	35 min	—			E	N								
19	7854	15:55	16:45	50 min	—			E	N								
20	7854	16:55	17:30	35 min	—			E	N								
22	7695	17:45	18:30	45 min	—			E	N								
27	7854	18:40	19:25	45 min	—			E	N								
								E	N								

<sup>1</sup> See bat forearm diagram on reverse of page.

<sup>3</sup> INJURY TYPES: None Visible / Broken Limb / Broken Neck / Broken Wing / Cut in Half / Decapitated / Head Injury / Severed Wing / Wound to Abdomen

### Mortality Survey Observation Form

Project No: 160961010  
 Date: June 8/2015  
 Start/End Time: 8:45 / 17:45

Project Name: Adelaide Wind Farm  
 Personnel: Ken Edwards

Weather Conditions: 19-23 16km/h / WSW 100%  
 TEMP (°C) WIND CLOUD yes PPT yes PPT (last 24-hrs)

DECOMPOSITION CODES<sup>2</sup>:  
 Fresh Moderate Complete  
 Early Advanced Scavenged

% VEG. COVER	VEG. HEIGHT	VISIBILITY CLASS <sup>4</sup>
≥ 90% bare ground	≤ 15cm tall	Class 1 (Easy)
≥ 25% bare ground	≤ 15cm tall	Class 2 (Moderate)
≤ 25% bare ground	≤ 25% > 30cm tall	Class 3 (Difficult)
Little/no bare ground	≥ 25% > 30cm tall	Class 4 (Very difficult)

Turbine No.	Area (m <sup>2</sup> )	Start Time	End Time	Duration	Species	Sex (m/f/u)	Bat Forearm <sup>1</sup> (mm)	UTM Coordinates		Decomposition Code <sup>2</sup>	Est. Hours Since Death	Injury <sup>3</sup> Sustained	Distance from Turbine (m)	Direction from Turbine	Substrate	Visibility Class <sup>4</sup>	Photo #	
								Zone	Easting									Northing
6	4347	8:45	9:25	40min	bat		TEST	177	E 045 1976	N 476 2603	TEST		8	NW	grass/ ground	2	/	
7	7854	9:35	10:15	40min	—				E	N								
11	7854	10:25	10:50	50min	—				E	N								
12	7854	11:25	12:15	50min	—				E	N								
14	7854	12:30	13:30	1hr	—				E	N								
17	3992	13:40	14:10	30min	bird		TEST	177	E 044 4536	N 476 5096	TEST		39	NE	grass	2	/	
19	7854	14:15	15:05	50min	—				E	N								
20	7854	15:15	16:05	50min	—				E	N								
22	7695	16:40	17:35	55min	silver bat	U	4.17	ITT	E 043 8269	N 476 3206	Moderate	1wk	none visible	35	W	field	1	5
27					weather: lightning				E	N	Moderate	1wk	none visible					

<sup>1</sup> See bat forearm diagram on reverse of page.

<sup>3</sup> INJURY TYPES: None Visible / Broken Limb / Broken Neck / Broken Wing / Cut in Half / Decapitated / Head Injury / Severed Wing / Wound to Abdomen

PAGE 1 OF 1

Print Name & Initial: Ken Edwards

(field notes author)

Quality Control:

Print Name & Initial: Anna Curran

(field notes QA/QC personnel)

This form is complete  & legible

### Mortality Survey Observation Form

\* Pictures and details of RTHA sent to A. Taylor + M. Straws right away  
↳ outside 50m radius, so incidental \*

Project No: 160961010      Project Name: Adelaide Wind Farm  
 Date: June 11, 2015      Personnel: Anna Corrigan  
 Start/End Time: 8:00am / 4:45

Weather Conditions: 14-23 5-13 / NW 40-100% 0 Thunderstorms  
 TEMP (°C)      km/h WIND      CLOUD      PPT      PPT (last 24-hrs)

speed/direction

DECOMPOSITION CODES:  
 Fresh      Moderate      Complete  
 Early      Advanced      Scavenged

% VEG. COVER	VEG. HEIGHT	VISIBILITY CLASS <sup>4</sup>
≥ 90% bare ground	≤ 15cm tall	Class 1 (Easy)
≥ 25% bare ground	≤ 15cm tall	Class 2 (Moderate)
≤ 25% bare ground	≤ 25% > 30cm tall	Class 3 (Difficult)
Little/no bare ground	≥ 25% > 30cm tall	Class 4 (Very difficult)

Turbine No.	Area (m <sup>2</sup> )	Start Time	End Time	Duration (mins)	Species	Sex (m/f/u)	Bat Forearm <sup>1</sup> (mm)	UTM Coordinates		Decomposition Code <sup>2</sup>	Est. Hours Since Death	Injury <sup>3</sup> Sustained	Distance from Turbine (m)	Direction from Turbine	Substrate	Visibility Class <sup>4</sup>	Photo #	
								Zone	Easting									Northing
7	6939	8:03	8:34	31	//			E	N									
6	4347	8:44	9:14	30	//			E	N									
11	7854	9:23	9:55	32	Red-tailed * Hawk	V	n/a	17	E 0449 183	N 4763 594	Early	24	Wound to Ab. Broken Neck	57	SE	Art / Soy	1	1-8
12	7854	10:20	10:51	31	//			E	N									
14	7854	10:58	11:28	30	//			E	N									
17	3992	11:35	12:05	30	//			E	N									
19	7854	12:11	12:43	32	//			E	N									
20	7854	12:54	13:24	30	//			E	N									
22	7695	13:30	14:01	31	//			E	N	* Bobolink seen while driving along access road *								
27	7854	14:11	14:41	30	//			E	N									
								E	N									

<sup>1</sup> See bat forearm diagram on reverse of page.

<sup>3</sup> INJURY TYPES: None Visible / Broken Limb / Broken Neck / Broken Wing / Cut in Half / Decapitated / Head Injury / Severed Wing / Wound to Abdomen

# Mortality Survey Observation Form

Project No: 160961010 Project Name: Adelaide Wind Farm

Date: June 15, 2015 Personnel: Anne Colligan

Start/End Time: 10:00am / 10:15

Weather Conditions: 23-24 12 / W 6-100% Fog / Drizzle / Rain  
 TEMP (°C) km/h WIND CLOUD PPT PPP (last 24-hrs)

DECOMPOSITION CODES<sup>2</sup>:  
 Fresh Moderate Complete  
 Early Advanced Scavenged

% VEG. COVER	VEG. HEIGHT	VISIBILITY CLASS <sup>4</sup>
≥ 90% bare ground	≤ 15cm tall	Class 1 (Easy)
≥ 25% bare ground	≤ 15cm tall	Class 2 (Moderate)
≤ 25% bare ground	≤ 25% > 30cm tall	Class 3 (Difficult)
Little/no bare ground	≥ 25% > 30cm tall	Class 4 (Very difficult)

Turbine No.	Area (m <sup>2</sup> )	Start Time	End Time	Duration (mins)	Species	Sex (m/f/u)	Bat Forearm <sup>1</sup> (mm)	UTM Coordinates			Decomposition Code <sup>2</sup>	Est. Hours Since Death	Injury <sup>3</sup> Sustained	Distance from Turbine (m)	Direction from Turbine	Substrate	Visibility Class <sup>4</sup>	Photo #
								Zone	Easting	Northing								
27	7854	10:08	10:40	32	/	* Saw 2		E		N								
								E		N								
20	7854	10:50	11:21	31	/			E		N								
19	7854	11:30	12:00	30	/			E		N								
17	3992	12:08	12:38	30	/			E		N								
14	7854	12:46	13:16	30	/			E		N								
12	7854	13:23	13:53	30	/			E		N								
7	6939	14:03	14:33	30	/			E		N								
6	4347	14:41	15:11	30	RTHA	U	n/a	17	E 451 953	N 4762 617	Early	24	Broken Neck	30	WNW dirt	1	9-13	
									E	N								
									E	N								
11	7854	15:35	16:08	33	/			E		N								
22								E		N								
								E		N								

<sup>1</sup> See bat forearm diagram on reverse of page.

<sup>3</sup> INJURY TYPES: None Visible / Broken Limb / Broken Neck / Broken Wing / Cut in Half / Decapitated / Head Injury / Severed Wing / Wound to Abdomen

PAGE 1 OF 1  
 Print Name & Initial: Anne Colligan AC  
 (field notes author)

Quality Control: Andrew Taylor A.T.  
 Print Name & Initial: Andrew Taylor A.T.  
 (field notes QA/QC personnel)

**Mortality Survey  
Observation Form**

Project No: 160961010  
Date: June 18/2015  
Start/End Time: 11:00 / 19:30

Project Name: Adelaide Wind Farm  
Personnel: Ken Edwards

Weather Conditions: 19 14km/h SE 100% no yes  
TEMP (°C) WIND CLOUD PPT PPT (last 24-hrs)  
speed/direction

DECOMPOSITION CODES:  
Fresh Moderate Complete  
Early Advanced Scavenged

% VEG. COVER	VEG. HEIGHT	VISIBILITY CLASS <sup>4</sup>
≥ 90% bare ground	≤ 15cm tall	Class 1 (Easy)
≥ 25% bare ground	≤ 15cm tall	Class 2 (Moderate)
≤ 25% bare ground	≤ 25% > 30cm tall	Class 3 (Difficult)
Little/no bare ground	≥ 25% > 30cm tall	Class 4 (Very difficult)

Turbine No.	Area (m <sup>2</sup> )	Start Time	End Time	Duration	Species	Sex (m/f/u)	Bat Forearm <sup>1</sup> (mm)	UTM Coordinates		Decomposition Code <sup>2</sup>	Est. Hours Since Death	Injury <sup>3</sup> Sustained	Distance from Turbine (m)	Direction from Turbine	Substrate	Visibility Class <sup>4</sup>	Photo #	
								Zone	Easting									Northing
27	7854	11:00	12:00	1h	Turkey vulture	U	—	17T	E 043 5989	N 476 5447	fresh	48	broken wing	17	N	ground	?	2
"	"	"	"	"	Turkey vulture	U	—	17T	E 043 5912	N 476 5441	fresh	48	broken wing/head injury	52	SW	ground	1	2
22	4701	12:00	12:40	35min	—				E	N								
20	7854	12:45	13:15	30min	—				E	N								
19	7854	13:30	14:10	40min	—				E	N								
17	2638	14:30	15:05	35min	—				E	N								
14	7854	15:05	15:55	40min	—				E	N								
12	6821	16:05	16:45	35min	—				E	N								
11	7854	16:55	17:30	35min	—				E	N								
7	7854	17:45	18:30	45min	—				E	N								
6	3423	18:40	19:10	30min	—				E	N								

<sup>1</sup> See bat forearm diagram on reverse of page.

<sup>3</sup> INJURY TYPES: None Visible / Broken Limb / Broken Neck / Broken Wing / Cut in Half / Decapitated / Head Injury / Severed Wing / Wound to Abdomen

PAGE 1 OF 1

Print Name & Initial: Ken Edwards KE  
(field notes author)

Quality Control:

Print Name & Initial: Anna Corrigan AC  
(field notes QA/QC personnel)

This form is complete  & legible

### Mortality Survey Observation Form

Project No: 160961010 Project Name: Adelaide Wind Farm  
 Date: June 22, 2015 Personnel: Ken Edwards  
 Start/End Time: 3:30 18:35

Weather Conditions: 15-26 20km/h S 50% no yes  
 TEMP (°C) WIND CLOUD PPT PPT (last 24-hrs)  
 speed/direction

DECOMPOSITION CODES<sup>2</sup>:  
 Fresh Moderate Complete  
 Early Advanced Scavenged

% VEG. COVER	VEG. HEIGHT	VISIBILITY CLASS <sup>4</sup>
≥ 90% bare ground	≤ 15cm tall	Class 1 (Easy)
≥ 25% bare ground	≤ 15cm tall	Class 2 (Moderate)
≤ 25% bare ground	≤ 25% > 30cm tall	Class 3 (Difficult)
Little/no bare ground	≥ 25% > 30cm tall	Class 4 (Very difficult)

Turbine No.	Area (m <sup>2</sup> )	Start Time	End Time	Duration	Species	Sex (m/f/u)	Bat Forearm <sup>1</sup> (mm)	UTM Coordinates			Decomposition Code <sup>2</sup>	Est. Hours Since Death	Injury <sup>3</sup> Sustained	Distance from Turbine (m)	Direction from Turbine	Substrate	Visibility Class <sup>4</sup>	Photo #
								Zone	Easting	Northing								
27	7854	3:30	4:00	30min	—				E	N								
22	4701	4:05	4:40	35min	—				E	N								
20	7854	4:50	5:30	40min	—				E	N								
19	7854	5:40	6:20	40min	bird	/	/	17T	E 044 2956	N 476 4933	-TEST CARCASS-		37	SW	grass/ Field	2	/	
17	2638	6:30	7:00	30min	—				E	N								
12	8821	7:10	7:45	35min	—				E	N								
6	3423	7:55	8:30	35min	—				E	N								
24, 14, 7 - lightning																		
									E	N								
									E	N								
									E	N								

<sup>1</sup> See bat forearm diagram on reverse of page.

<sup>3</sup> INJURY TYPES: None Visible / Broken Limb / Broken Neck / Broken Wing / Cut in Half / Decapitated / Head Injury / Severed Wing / Wound to Abdomen

PAGE 1 OF 1

Print Name & Initial: Ken Edwards KE  
 (field notes author)

Quality Control: \_\_\_\_\_ This form is complete  & legible   
 Print Name & Initial: Anna Carigan AC  
 (field notes QA/QC personnel)

### Mortality Survey Observation Form

Project No: 160961010  
 Date: June 25/2015  
 Start/End Time: 8:40 14:45

Project Name: Adelaide Wind Farm  
 Personnel: Ken Edwards

Weather Conditions: 24 TEMP (°C) 6km/h WIND speed/direction S 100% CLOUD no PPT no PPT (last 24-hrs)

DECOMPOSITION CODES<sup>2</sup>:  
 Fresh Moderate Complete  
 Early Advanced Scavenged

% VEG. COVER	VEG. HEIGHT	VISIBILITY CLASS <sup>4</sup>
≥ 90% bare ground	≤ 15cm tall	Class 1 (Easy)
≥ 25% bare ground	≤ 15cm tall	Class 2 (Moderate)
≤ 25% bare ground	≤ 25% > 30cm tall	Class 3 (Difficult)
Little/no bare ground	≥ 25% > 30cm tall	Class 4 (Very difficult)

Turbine No.	Area (m <sup>2</sup> )	Start Time	End Time	Duration	Species	Sex (m/f/u)	Bat Forearm <sup>1</sup> (mm)	UTM Coordinates		Decomposition Code <sup>2</sup>	Est. Hours Since Death	Injury <sup>3</sup> Sustained	Distance from Turbine (m)	Direction from Turbine	Substrate	Visibility Class <sup>4</sup>	Photo #
								Zone	Eastings								
6	3423	8:40	9:10	30min	—			E	N								
7	7854	9:15	9:55	40min	—			E	N								
11	7854	10:00	10:35	35min	—			E	N								
14	7854	10:40	11:15	35min	—			E	N								
19	7854	11:25	12:00	35min	—			E	N								
20	7854	12:30	13:10	40min	—			E	N								
22	4701	13:25	14:05	40min	—			E	N								
27	7854	14:10	14:45	35min	—			E	N								
12	Road construction																
17	Road construction																
								E	N								

<sup>1</sup> See bat forearm diagram on reverse of page.

<sup>3</sup> INJURY TYPES: None Visible / Broken Limb / Broken Neck / Broken Wing / Cut in Half / Decapitated / Head Injury / Severed Wing / Wound to Abdomen

PAGE 1 OF 1  
 Print Name & Initial: Ken Edwards KE  
 (field notes author)

Quality Control: \_\_\_\_\_ This form is complete  & legible   
 Print Name & Initial: Anna Corrigan AC  
 (field notes QA/QC personnel)



### Mortality Survey Observation Form

Project No: 160961010  
 Date: June 29/2015  
 Start/End Time: 8:30 14:05

Project Name: Adelaide Wind Farm  
 Personnel: Ken Edwards

Weather Conditions: 9-25 km/h / S 30% no yes  
 TEMP (°C) WIND CLOUD PPT PPT (last 24-hrs)  
 speed/direction

DECOMPOSITION CODES<sup>2</sup>:  
 Fresh Moderate Complete  
 Early Advanced Scavenged

% VEG. COVER	VEG. HEIGHT	VISIBILITY CLASS <sup>4</sup>
≥ 90% bare ground	≤ 15cm tall	Class 1 (Easy)
≥ 25% bare ground	≤ 15cm tall	Class 2 (Moderate)
≤ 25% bare ground	≤ 25% > 30cm tall	Class 3 (Difficult)
Little/no bare ground	≥ 25% > 30cm tall	Class 4 (Very difficult)

Turbine No.	Area (m <sup>2</sup> )	Start Time	End Time	Duration	Species	Sex (m/f/u)	Bat Forearm <sup>1</sup> (mm)	UTM Coordinates		Decomposition Code <sup>2</sup>	Est. Hours Since Death	Injury <sup>3</sup> Sustained	Distance from Turbine (m)	Direction from Turbine	Substrate	Visibility Class <sup>4</sup>	Photo #	
								Zone	Easting									Northing
6	3423	8:30	9:10	40min	bird	U	-	17T	E 045 1963	N 476 2657	advanced	2wks +	no	52	NNW	soy field	2	1
7	7854	9:18	10:00	47min	hoary bat	-	-	17T	E 044 9690	N 476 2163	-	-	-	30	NE	soy field	2	-
11	7854	10:10	11:00	50min	-	-	-											
14	7854	11:10	12:00	50min	bird	-	-	17T	E 044 7130	N 476 4849	-	-	-	39	W	corn field	2	-
17	9639	12:35	1:10	35min	-	-	-											
19	7854	1:15	1:45	30min	-	-	-											
20	7854	1:55	2:30	35min	hoary bat	-	-	17T	E 044 0258	N 476 5234	-	-	-	12	NWE	ground	1	-
22	4801	2:40	3:20	40min	-	-	-											
27	7854	3:30	4:05	35min	-	-	-											

<sup>1</sup> See bat forearm diagram on reverse of page.

<sup>3</sup> INJURY TYPES: None Visible / Broken Limb / Broken Neck / Broken Wing / Cut In Half / Decapitated / Head Injury / Severed Wing / Wound to Abdomen

**Mortality Survey  
Observation Form**

Project No: 160961010

Project Name: Adelaide Wind Farm

Date: July 2, 2015

Personnel: Ken Edwards

Start/End Time: 2:30 11:45

Weather Conditions: 16-21 5km/L/N 10% Ø Ø  
 TEMP (°C) WIND CLOUD PPT PPT (last 24-hrs)  
 speed/direction

DECOMPOSITION CODES<sup>2</sup>:  
 Fresh Moderate Complete  
 Early Advanced Scavenged

% VEG. COVER	VEG. HEIGHT	VISIBILITY CLASS <sup>4</sup>
≥ 90% bare ground	≤ 15cm tall	Class 1 (Easy)
≥ 25% bare ground	≤ 15cm tall	Class 2 (Moderate)
≤ 25% bare ground	≤ 25% > 30cm tall	Class 3 (Difficult)
Little/no bare ground	≥ 25% > 30cm tall	Class 4 (Very difficult)

Turbine No.	Area (m <sup>2</sup> )	Start Time	End Time	Duration	Species	Sex (m/f/u)	Bat Forearm <sup>1</sup> (mm)	UTM Coordinates		Decomposition Code <sup>2</sup>	Est. Hours Since Death	Injury <sup>3</sup> Sustained	Distance from Turbine (m)	Direction from Turbine	Substrate	Visibility Class <sup>4</sup>	Photo #
								Zone	Easting								
6	3423	8:30	9:05	35 min	—			E	N								
11	7854	9:15	10:20	1h 5 min	bat	U	44	17T E044	N476	advanced decomp	2-3 hrs	NU	53	WSW	soy field	2	2
12	6821	10:30	11:20	50 min	—			E	N								
20	7854	11:35	12:20	45 min	—			E	N								
22	4701	12:30	13:15	45 min	—			E	N								
27	7854	13:30	14:00	30 min	—			E	N								
17	4639	14:15	14:55	40 min	—			E	N								
14	7854	15:10	16:00	50 min	—			E	N								
19	7854	16:10	16:45	35 min	—			E	N								
7	maintenance																
								E	N								
								E	N								

<sup>1</sup> See bat forearm diagram on reverse of page.

<sup>3</sup> INJURY TYPES: None Visible / Broken Limb / Broken Neck / Broken Wing / Cut in Half / Decapitated / Head Injury / Severed Wing / Wound to Abdomen

PAGE 1 OF 1

Print Name & Initial: Ken Edwards KE  
 (field notes author)

Quality Control: This form is complete  & legible

Print Name & Initial: Anna Corrigan AC  
 (field notes QA/QC personnel)



# Mortality Survey Observation Form

Project No: 160961010

Project Name: Abelade Wind Farm

Date: July 6, 2015

Personnel: Ken Edwards

Start/End Time: 8:30 / 16:05

Weather Conditions: 27 5km/h SE  
TEMP (°C) WIND speed/direction

8 0 0  
CLOUD PPT PPT (last 24-hrs)

**DECOMPOSITION CODES<sup>2</sup>:**

Fresh Moderate Complete  
Early Advanced Scavenged

% VEG. COVER	VEG. HEIGHT	VISIBILITY CLASS <sup>4</sup>
≥ 90% bare ground	≤ 15cm tall	Class 1 (Easy)
≥ 25% bare ground	≤ 15cm tall	Class 2 (Moderate)
≤ 25% bare ground	≤ 25% > 30cm tall	Class 3 (Difficult)
Little/no bare ground	≥ 25% > 30cm tall	Class 4 (Very difficult)

Turbine No.	Area (m <sup>2</sup> )	Start Time	End Time	Duration	Species	Sex (m/f/u)	Bat Forearm <sup>1</sup> (mm)	UTM Coordinates		Decomposition Code <sup>2</sup>	Est. Hours Since Death	Injury <sup>3</sup> Sustained	Distance from Turbine (m)	Direction from Turbine	Substrate	Visibility Class <sup>4</sup>	Photo #
								Zone	Easting								
6	3423	8:30	9:10	40min	—			E	N								
11	7854	9:25	10:10	45min	—			E	N								
12	6821	10:15	11:05	50min	—			E	N								
19	7854	11:35	12:10	35min	—			E	N								
20	7854	12:20	12:50	30min	—			E	N								
22	4701	13:00	13:30	30min	—			E	N								
27	7854	13:40	14:15	35min	—			E	N								
17	4639	14:25	15:00	35min	—			E	N								
14	7854	15:10	15:50	40min	—			E	N								
7	maintenance																
								E	N								
								E	N								

<sup>1</sup> See bat forearm diagram on reverse of page.

<sup>3</sup> INJURY TYPES: None Visible / Broken Limb / Broken Neck / Broken Wing / Cut in Half / Decapitated / Head Injury / Severed Wing / Wound to Abdomen

PAGE 1 OF 1

Print Name & Initial: Ken Edwards KE  
(field notes author)

Quality Control: This form is complete  & legible

Print Name & Initial: Anna Cornigan AC  
(field notes QA/QC personnel)

## Mortality Survey Observation Form

Project No: 160961010  
 Date: July 9/2015  
 Start/End Time: 8:30 / 17:20

Project Name: Adelaide Wind Farm  
 Personnel: Ken Edwards

Weather Conditions: 12 TEMP (°C)    6km/h / E WIND speed/direction    80% CLOUD    light PPT    light PPT (last 24-hrs)

DECOMPOSITION CODES<sup>2</sup>:  
 Fresh      Moderate      Complete  
 Early      Advanced      Scavenged

% VEG. COVER	VEG. HEIGHT	VISIBILITY CLASS <sup>4</sup>
≥ 90% bare ground	≤ 15cm tall	Class 1 (Easy)
≥ 25% bare ground	≤ 15cm tall	Class 2 (Moderate)
≤ 25% bare ground	≤ 25% > 30cm tall	Class 3 (Difficult)
Little/no bare ground	≥ 25% > 30cm tall	Class 4 (Very difficult)

Turbine No.	Area (m <sup>2</sup> )	Start Time	End Time	Duration	Species	Sex (m/f/u)	Bat Forearm <sup>1</sup> (mm)	UTM Coordinates		Decomposition Code <sup>2</sup>	Est. Hours Since Death	Injury <sup>3</sup> Sustained	Distance from Turbine (m)	Direction from Turbine	Substrate	Visibility Class <sup>4</sup>	Photo #
								Zone	Easting								
6	5368	8:30	9:20	50min	—			E	N								
7	7854	9:30	10:10	40min	—			E	N								
11	6972	10:25	11:15	50min	hoary bat	/	/	E 044 9177	N 476 3595	/	/	/	31	NE	soy field	2	/
12	6821	11:25	12:15	50min	—			E	N								
14	7854	12:25	13:15	50min	—			E	N								
17	4639	13:45	14:45	1hr	med. bird	U	—	E 044 4527	N 476 5049	fresh	<24	none visible	21	ESE	grass	2	2
19	7854	14:55	15:40	45min	—			E	N								
20	7854	15:50	16:25	35min	—			E	N								
27	7854	16:35	17:15	40min	—			E	N								
22	Construction / tile																
								E	N								
								E	N								

<sup>1</sup> See bat forearm diagram on reverse of page.

<sup>3</sup> INJURY TYPES: None Visible / Broken Limb / Broken Neck / Broken Wing / Cut in Half / Decapitated / Head Injury / Severed Wing / Wound to Abdomen

PAGE 1 OF 1

Print Name & Initial: Ken Edwards KE  
 (field notes author)

Quality Control: Anna Corrigan AC      This form is complete  & legible   
 Print Name & Initial: Anna Corrigan AC  
 (field notes QA/QC personnel)

## Mortality Survey Observation Form

Project No: 160961010      Project Name: Adelaide Wind Farm  
 Date: July 13/2015      Personnel: Ken Edwards  
 Start/End Time: 8:30 / 18:10  
 Weather Conditions: 20-27 13km/h SE      0%      Ø      Ø  
 TEMP (°C)      WIND      CLOUD      PPT      PPT (last 24-hrs)  
speed/direction

**DECOMPOSITION CODES<sup>2</sup>:**  
 Fresh      Moderate      Complete  
 Early      Advanced      Scavenged

% VEG. COVER	VEG. HEIGHT	VISIBILITY CLASS <sup>4</sup>
≥ 90% bare ground	≤ 15cm tall	Class 1 (Easy)
≥ 25% bare ground	≤ 15cm tall	Class 2 (Moderate)
≤ 25% bare ground	≤ 25% > 30cm tall	Class 3 (Difficult)
Little/no bare ground	≥ 25% > 30cm tall	Class 4 (Very difficult)

Turbine No.	Area (m <sup>2</sup> )	Start Time	End Time	Duration	Species	Sex (m/f/u)	Bat Forearm <sup>1</sup> (mm)	UTM Coordinates			Decomposition Code <sup>2</sup>	Est. Hours Since Death	Injury <sup>3</sup> Sustained	Distance from Turbine (m)	Direction from Turbine	Substrate	Visibility Class <sup>4</sup>	Photo #
								Zone	Easting	Northing								
6	5368	8:30	9:20	50 min	—			E	N									
11	7854	9:35	10:25	50 min	—			E	N									
14	7854	10:35	11:20	45 min	—			E	N									
17	4639	11:30	12:15	45 min	—			E	N									
27	7854	12:45	13:30	45 min	—			E	N									
22	5268	13:45	14:20	35 min	—			E	N									
20	7854	14:30	15:05	35 min	—			E	N									
19	7854	15:20	16:00	40 min	—			E	N									
12	2928	16:30	17:00	30 min	<del>big brown bat</del>		42.6	E	N									
37	7012	17:05	18:05	50 min	big brown bat	m	42.6	E044 9653	N476 2137	Fres L	<24	severed wing	14	SW	gravel	1	3	
								E	N									
								E	N									

<sup>1</sup> See bat forearm diagram on reverse of page.

<sup>3</sup> INJURY TYPES: None Visible / Broken Limb / Broken Neck / Broken Wing / Cut in Half / Decapitated / Head Injury / Severed Wing / Wound to Abdomen

PAGE 1 OF 1

Print Name & Initial: Ken Edwards KE  
(field notes author)

Quality Control: \_\_\_\_\_ This form is complete  & legible

Print Name & Initial: Anna Corrigan AC  
(field notes QA/QC personnel)

## Mortality Survey Observation Form

Project No: 160961010  
 Date: July 16, 2015  
 Start/End Time: 8:30 17:35

Project Name: Adelaide Wind Farm  
 Personnel: Ken Edwards

Weather Conditions: 18-23 10k/h SE  
 TEMP (°C) WIND speed/direction

CLOUD ☉ PPT ☉ PPT (last 24-hrs) ☉

DECOMPOSITION CODES<sup>2</sup>:  
 Fresh Moderate Complete  
 Early Advanced Scavenged

% VEG. COVER	VEG. HEIGHT	VISIBILITY CLASS <sup>4</sup>
≥ 90% bare ground	≤ 15cm tall	Class 1 (Easy)
≥ 25% bare ground	≤ 15cm tall	Class 2 (Moderate)
≤ 25% bare ground	≤ 25% > 30cm tall	Class 3 (Difficult)
Little/no bare ground	≥ 25% > 30cm tall	Class 4 (Very difficult)

Turbine No.	Area (m <sup>2</sup> )	Start Time	End Time	Duration	Species	Sex (m/f/u)	Bat Forearm <sup>1</sup> (mm)	UTM Coordinates			Decomposition Code <sup>2</sup>	Est. Hours Since Death	Injury <sup>3</sup> Sustained	Distance from Turbine (m)	Direction from Turbine	Substrate	Visibility Class <sup>4</sup>	Photo #
								Zone	Easting	Northing								
6	5368	8:35	9:20	45min	—			E	N									
7	7012	9:30	10:10	40min	—			E	N									
11	7854	10:20	11:10	50min	—			E	N									
12	<del>2438</del> 2438	11:40	12:40	1 hr	65g Grön	F	44.7	E 044 7868	N 476 3342	early	72	none visib	10	S	grass/ ground	2	2	
14	7854	12:50	13:40	50min	—			E	N									
17	4639	13:50	14:40	50min	—			E	N									
19	<del>7854</del>	14:50	15:30	40min	—			E	N									
20	7854	15:40	16:20	40min	—			E	N									
22	<del>5268</del> 5268	16:30	17:00	30min	small bird	/	/	E 043 8330	N 476 3236	-TESTER CARCASS-	36			NE	ground	1		
27	<del>7854</del>	17:10	17:55	45min	—			E	N									
								E	N									

<sup>1</sup> See bat forearm diagram on reverse of page.

<sup>3</sup> INJURY TYPES: None Visible / Broken Limb / Broken Neck / Broken Wing / Cut in Half / Decapitated / Head Injury / Severed Wing / Wound to Abdomen

PAGE 1 OF 1

Print Name & Initial: Ken Edwards KE  
 (field notes author)

Quality Control:

Print Name & Initial: Anna Corina  
 (field notes QA/QC person)

This form is complete  & legible

### Mortality Survey Observation Form

Project No: 160961010 Project Name: Melbide Wind Farm  
 Date: July 20/2015 Personnel: Ken Edwards  
 Start/End Time: 8:30 17:30  
 Weather Conditions: 27 14km/h SW 70% no yes  
 TEMP (°C) WIND CLOUD PPT PPT (last 24-hrs)  
 speed/direction

DECOMPOSITION CODES<sup>2</sup>:  
 Fresh Moderate Complete  
 Early Advanced Scavenged

% VEG. COVER	VEG. HEIGHT	VISIBILITY CLASS <sup>4</sup>
≥ 90% bare ground	≤ 15cm tall	Class 1 (Easy)
≥ 25% bare ground	≤ 15cm tall	Class 2 (Moderate)
≤ 25% bare ground	≤ 25% > 30cm tall	Class 3 (Difficult)
Little/no bare ground	≥ 25% > 30cm tall	Class 4 (Very difficult)

Turbine No.	Area (m <sup>2</sup> )	Start Time	End Time	Duration	Species	Sex (m/f/u)	Bat Forearm <sup>1</sup> (mm)	UTM Coordinates		Decomposition Code <sup>2</sup>	Est. Hours Since Death	Injury <sup>3</sup> Sustained	Distance from Turbine (m)	Direction from Turbine	Substrate	Visibility Class <sup>4</sup>	Photo #
								Zone	Easting								
27	7854	9:30	10:10	40 min	Hoary bat	u	/	17T E043 5938	N476 5448	Fresh	224	none visible	27	SW	grassy ground	2	/
22	5268	10:20	10:50	30 min	—			E	N								
20	7854	11:00	11:30	30 min	—			E	N								
19	6411	11:40	12:25	45 min	hoary bat	m	/	17T E044 2939	N476 4962	Fresh	48	none visible	8	NW	ground	1	/
17	4639	12:35	13:15	40 min	—			E	N								
14	4856	13:25	14:00	35 min	—			E	N								
12	2438	14:18	14:58	40 min	—			E	N								
11	2518	15:18	15:40	30 min	—			E	N								
7	6629	16:05	16:45	40 min	—			E	N								
6	5368	16:55	17:30	35 min	—			E	N								

<sup>1</sup> See bat forearm diagram on reverse of page.

<sup>3</sup> INJURY TYPES: None Visible / Broken Limb / Broken Neck / Broken Wing / Cut in Half / Decapitated / Head Injury / Severed Wing / Wound to Abdomen

PAGE 1 OF 1

Print Name & Initial: Ken Edwards

(field notes author)

Quality Control:

Print Name & Initial: Anna Corriean

(field notes QA/QC personnel)

This form is complete  & legible



# Mortality Survey Observation Form

Project No: 160961010 Project Name: Adelaide Wind Farm  
 Date: July 23, 2015 Personnel: Ken Edwards

Start/End Time: 6:50 / 17:00

Weather Conditions: 20-24 10km/h NW  
 TEMP (°C) WIND speed/direction CLOUD PPT PPT (last 24-hrs)

DECOMPOSITION CODES:  
 Fresh Moderate Complete  
 Early Advanced Scavenged

% VEG. COVER	VEG. HEIGHT	VISIBILITY CLASS <sup>4</sup>
≥ 90% bare ground	≤ 15cm tall	Class 1 (Easy)
≥ 25% bare ground	≤ 15cm tall	Class 2 (Moderate)
≤ 25% bare ground	≤ 25% > 30cm tall	Class 3 (Difficult)
Little/no bare ground	≥ 25% > 30cm tall	Class 4 (Very difficult)

Turbine No.	Area (m <sup>2</sup> )	Start Time	End Time	Duration	Species	Sex (m/f/u)	Bat Forearm <sup>1</sup> (mm)	UTM Coordinates		Decomposition Code <sup>2</sup>	Est. Hours Since Death	Injury <sup>3</sup> Sustained	Distance from Turbine (m)	Direction from Turbine	Substrate	Visibility Class <sup>4</sup>	Photo #	
								Zone	Easting									Northing
6	6574	8:50	9:35	45 min	HOARY bat	u	52.04	17T	E 045 1962	N 476 2593	fresh	<24	none visible	15	SW	gravel	1	1
7	6629	9:15	10:35	50 min	med bird	/	/	17T	E 644 9656	N 476 2149	-TEST CARCASS	—	8	N	ground	1	/	
11	2378	10:45	11:15	30 min	—				E	N								
14	4856	11:25	12:05	40 min	—				E	N								
17	4639	12:15	13:05	50 min	—				E	N								
19	6411	13:15	14:00	45 min	—				E	N								
22	5268	14:10	14:40	30 min	—				E	N								
27	7854	14:50	15:40	50 min	—				E	N								
12	2438	15:30	16:40	50 min	—				E	N								
20	farming activities present																	

<sup>1</sup> See bat forearm diagram on reverse of page.

<sup>3</sup> INJURY TYPES: None Visible / Broken Limb / Broken Neck / Broken Wing / Cut in Half / Decapitated / Head Injury / Severed Wing / Wound to Abdomen

PAGE 1 OF 1

Print Name & Initial: Ken Edwards KE  
 (field notes author)

Quality Control:

Print Name & Initial: Anna Carrigan AC  
 (field notes QA/QC personnel)

This form is complete  & legible



### Mortality Survey Observation Form

Project No: 160961010  
 Date: July 27/2015  
 Start/End Time: 8:40 / 16:00

Project Name: Adelaide Wind Farm  
 Personnel: Ken Edwards

Weather Conditions: 27-31 2km/h SE  
 TEMP (°C) WIND speed/direction

CLOUD  PPT  PPT (last 24-hrs)

DECOMPOSITION CODES:  
 Fresh Moderate Complete  
 Early Advanced Scavenged

% VEG. COVER	VEG. HEIGHT	VISIBILITY CLASS <sup>4</sup>
≥ 90% bare ground	≤ 15cm tall	Class 1 (Easy)
≥ 25% bare ground	≤ 15cm tall	Class 2 (Moderate)
≤ 25% bare ground	≤ 25% > 30cm tall	Class 3 (Difficult)
Little/no bare ground	≥ 25% > 30cm tall	Class 4 (Very difficult)

Turbine No.	Area (m <sup>2</sup> )	Start Time	End Time	Duration	Species	Sex (m/f/u)	Bat Forearm <sup>1</sup> (mm)	UTM Coordinates		Decomposition Code <sup>2</sup>	Est. Hours Since Death	Injury <sup>3</sup> Sustained	Distance from Turbine (m)	Direction from Turbine	Substrate	Visibility Class <sup>4</sup>	Photo #
								Zone	Easting								
6	65248	8:40	9:25	45min	—			E	N								
7	6629	9:35	10:10	35min	—			E	N								
12	2378	10:20	11:00	40min	—			E	N								
14	4856	11:05	11:35	30min	—			E	N								
17	4639	11:45	12:30	45min	—			E	N								
19	6411	13:00	13:45	45min	—			E	N								
22	5268	13:55	14:34	40min	hoary	U	61.04	E 043 8309	N 476 3242	fresh	< 24	none visible	23	N	ground	1	1
27	7854	14:45	15:15	30min	—			E	N								
11	2436	15:30	16:00	30	—			E	N								
20	blocked / farming activities / road construction																

<sup>1</sup> See bat forearm diagram on reverse of page.

<sup>3</sup> INJURY TYPES: None Visible / Broken Limb / Broken Neck / Broken Wing / Cut in Half / Decapitated / Head Injury / Severed Wing / Wound to Abdomen

PAGE 1 OF 1

Print Name & Initial: Ken Edwards KE  
 (field notes author)

Quality Control: This form is complete  & legible

Print Name & Initial: Anna Corrigan AC  
 (field notes QA/QC personnel)

## Mortality Survey Observation Form

Project No: 160961010      Project Name: Adelaide Wind Farm  
 Date: July 30/2015      Personnel: Ken Edwards  
 Start/End Time: 8:40 / 16:35  
 Weather Conditions: 19-30 14km/h / W      0      0      light  
 TEMP (°C)      WIND      CLOUD      PPT      PPT (last 24-hrs)  
speed/direction

**DECOMPOSITION CODES<sup>2</sup>:**  
 Fresh      Moderate      Complete  
 Early      Advanced      Scavenged

% VEG. COVER	VEG. HEIGHT	VISIBILITY CLASS <sup>4</sup>
≥ 90% bare ground	≤ 15cm tall	Class 1 (Easy)
≥ 25% bare ground	≤ 15cm tall	Class 2 (Moderate)
≤ 25% bare ground	≤ 25% > 30cm tall	Class 3 (Difficult)
Little/no bare ground	≥ 25% > 30cm tall	Class 4 (Very difficult)

Turbine No.	Area (m <sup>2</sup> )	Start Time	End Time	Duration	Species	Sex (m/f/u)	Bat Forearm <sup>1</sup> (mm)	UTM Coordinates		Decomposition Code <sup>2</sup>	Est. Hours Since Death	Injury <sup>3</sup> Sustained	Distance from Turbine (m)	Direction from Turbine	Substrate	Visibility Class <sup>4</sup>	Photo #	
								Zone	Easting									Northing
6	5524	8:40	9:10	40min	—			E	N									
7	6629	9:20	10:10	40min	—			E	N									
11	<del>2436</del>	10:15	10:45	30min	—			E	N									
12	<del>2078</del>	10:55	11:35	40min	—			E	N									
17	4639	11:35	12:45	50min	Small cliff swallow bird		—	17T	E044 4507	N476 5053	early	48	head injury	16	S	grass/ground	2	1
19	4411	12:55	13:40	45min	—			E	N									
20	<del>7854</del>	13:55	14:45	50min	big brown	u	48.55	17T	E044 0245	N476 5223	moderate	week	none visible	10	W	ground	1	2
22	5668	14:55	15:30	35min	—			E	N									
27	7432	15:40	16:30	50min	med. bird	/	/	17T	E043 5954	N476 5465	-TEST CARCASS			8	NW	gravel	/	/
14	farming activities / maintenance																	
								E	N									
								E	N									

<sup>1</sup> See bat forearm diagram on reverse of page.

<sup>3</sup> INJURY TYPES: None Visible / Broken Limb / Broken Neck / Broken Wing / Cut in Half / Decapitated / Head Injury / Severed Wing / Wound to Abdomen

PAGE 1 OF 1

Print Name & Initial: Ken Edwards  
(field notes author)

Quality Control:

Print Name & Initial: Anna Corrigan  
(field notes QA/QC personnel)

This form is complete  & legible

### Mortality Survey Observation Form

Project No: 160961010 Project Name: Adelarside Wind Farm  
 Date: Aug 4/2015 Personnel: Ken Edwards  
 Start/End Time: 8:40 am / 16:10

Weather Conditions: 22-24 Skn/ 1NW 30% Ø Ø  
 TEMP (°C) WIND CLOUD PPT PPT (last 24-hrs)  
 speed/direction

DECOMPOSITION CODES<sup>2</sup>:  
 Fresh Moderate Complete  
 Early Advanced Scavenged

% VEG. COVER	VEG. HEIGHT	VISIBILITY CLASS <sup>4</sup>
≥ 90% bare ground	≤ 15cm tall	Class 1 (Easy)
≥ 25% bare ground	≤ 15cm tall	Class 2 (Moderate)
≤ 25% bare ground	≤ 25% > 30cm tall	Class 3 (Difficult)
Little/no bare ground	≥ 25% > 30cm tall	Class 4 (Very difficult)

Turbine No.	Area (m <sup>2</sup> )	Start Time	End Time	Duration	Species	Sex (m/f/u)	Bat Forearm <sup>1</sup> (mm)	UTM Coordinates			Decomposition Code <sup>2</sup>	Est. Hours Since Death	Injury <sup>3</sup> Sustained	Distance from Turbine (m)	Direction from Turbine	Substrate	Visibility Class <sup>4</sup>	Photo #
								Zone	Easting	Northing								
6	6524	8:45	9:35	50min	big brown	u	50.9	17T	E 045 1979	N 476 2826	moderate	week	none visible	10	SW	ground	1	Z
7	6629	9:45	10:15	30min	—				E	N								
11	2436	10:25	10:55	30min	—				E	N								
12	6895	11:05	11:35	30min	—				E	N								
17	7854	11:45	12:15	30min	—				E	N								
19	6411	12:25	12:55	30min	—				E	N								
20	7854	13:05	13:45	40min	—				E	N								
22	5268	13:55	14:45	50min	big brown	u	49.27	17T	E 043 8316	N 476 3201	moderate	week	none visible	7	SE	ground	1	Z
27	7432	14:55	15:25	30min	—				E	N								
14	3925	15:40	16:10	30min	—				E	N								
									E	N								

1 See bat forearm diagram on reverse of page.

3 INJURY TYPES: None Visible / Broken Limb / Broken Neck / Broken Wing / Cut in Half / Decapitated / Head Injury / Severed Wing / Wound to Abdomen

PAGE 1 OF 1

Print Name & Initial: Ken Edwards KE  
 (field notes author)

Quality Control: This form is complete  & legible

Print Name & Initial: Anne Corrigan AC  
 (field notes QA/QC personnel)

**Mortality Survey  
Observation Form**

Project No: 160961010

Project Name: Adelaide

Date: Aug 7, 2015

Personnel: Ken Edwards

Start/End Time: 8:45 / 16:00

Weather Conditions: 26 6km/h / E 20% Ø Ø  
 TEMP (°C) WIND CLOUD PPT PPT (last 24-hrs)  
 speed/direction

DECOMPOSITION CODES<sup>2</sup>:  
 Fresh Moderate Complete  
 Early Advanced Scavenged

% VEG. COVER	VEG. HEIGHT	VISIBILITY CLASS <sup>4</sup>
≥ 90% bare ground	≤ 15cm tall	Class 1 (Easy)
≥ 25% bare ground	≤ 15cm tall	Class 2 (Moderate)
≤ 25% bare ground	≤ 25% > 30cm tall	Class 3 (Difficult)
Little/no bare ground	≥ 25% > 30cm tall	Class 4 (Very difficult)

Turbine No.	Area (m <sup>2</sup> )	Start Time	End Time	Duration	Species	Sex (m/f/u)	Bat Forearm <sup>1</sup> (mm)	UTM Coordinates			Decomposition Code <sup>2</sup>	Est. Hours Since Death	Injury <sup>3</sup> Sustained	Distance from Turbine (m)	Direction from Turbine	Substrate	Visibility Class <sup>4</sup>	Photo #
								Zone	Easting	Northing								
6	6524845	9:15	9:45	45 min	→			E		N								
7	6629	9:25	9:55	30 min	→			E		N								
11	2436	10:05	10:35	30 min	→			E		N								
12	6895	10:45	11:30	45 min	→			E		N								
14	3925	11:40	12:15	35 min	→			E		N								
17	7854	12:25	13:05	40 min	→			E		N								
19	641	13:15	13:50	35 min	big brown med. bird	/	/	E 044	N 476	2943	4958	-TEST CARCASS-	13	S	ground	1	/	
20	7854	14:00	14:35	35 min	bird	/	/	E 044	N 476	0257	5248	-TEST CARCASS-	21	N	ground	1	/	
22	5262	14:45	15:15	30 min	→			E		N								
27	7432	15:25	15:55	30 min	→			E		N								

<sup>1</sup> See bat forearm diagram on reverse of page.

<sup>3</sup> INJURY TYPES: None Visible / Broken Limb / Broken Neck / Broken Wing / Cut in Half / Decapitated / Head Injury / Severed Wing / Wound to Abdomen

PAGE 1 OF 1

Print Name & Initial: Ken Edwards KE  
 (field notes author)

Quality Control: This form is complete  & legible

Print Name & Initial: Anna Conigan  
 (field notes QA/QC personnel)

### Mortality Survey Observation Form

Project No: 160961010  
 Date: Aug 10, 2015  
 Start/End Time: 8:45 / 13:00

Project Name: Adelaide Wind Farm  
 Personnel: Ken Edwards

Weather Conditions: 7-25 km/h / E 100% light Ø  
 TEMP (°C) WIND CLOUD PPT PPT (last 24-hrs)  
 speed/direction

DECOMPOSITION CODES<sup>2</sup>:  
 Fresh Moderate Complete  
 Early Advanced Scavenged

% VEG. COVER	VEG. HEIGHT	VISIBILITY CLASS <sup>4</sup>
≥ 90% bare ground	≤ 15cm tall	Class 1 (Easy)
≥ 25% bare ground	≤ 15cm tall	Class 2 (Moderate)
≤ 25% bare ground	≤ 25% > 30cm tall	Class 3 (Difficult)
Little/no bare ground	≥ 25% > 30cm tall	Class 4 (Very difficult)

Turbine No.	Area (m <sup>2</sup> )	Start Time	End Time	Duration	Species	Sex (m/f/u)	Bat Forearm <sup>1</sup> (mm)	UTM Coordinates			Decomposition Code <sup>2</sup>	Est. Hours Since Death	Injury <sup>3</sup> Sustained	Distance from Turbine (m)	Direction from Turbine	Substrate	Visibility Class <sup>4</sup>	Photo #
								Zone	Easting	Northing								
6	6524	8:45	9:40	55min	Tree Swallow	u	-	17T	E 045 1962	N 476 2607	early	2-3 days	broken wing	13	SW	gravel	1	1
7	6629	9:50	10:25	35min	-				E	N								
11	2436	10:35	11:05	30min	-				E	N								
12	6895	11:10	11:50	40min	-				E	N								
14	3125	12:05	12:55	50min	hoary bat	u	58,98	17T	E 044 7209	N 476 4827	early <del>moderate</del>	3 days	none visible	41	SE	soy	2	1
17									E	N								
19									E	N								
20									E	N								
22									E	N								
27									E	N								
									E	N								
									E	N								

<sup>1</sup> See bat forearm diagram on reverse of page.

<sup>3</sup> INJURY TYPES: None Visible / Broken Limb / Broken Neck / Broken Wing / Cut in Half / Decapitated / Head Injury / Severed Wing / Wound to Abdomen



## Mortality Survey Observation Form

 Project No: 160961010

 Project Name: Abelale Wind Farm

 Date: Aug 11, 2015

 Personnel: Ken Edwards

 Start/End Time: 10:30 11:43:35

 Weather Conditions: 20-22 18kph / NW 80% no yes  
 TEMP (°C) WIND CLOUD PPT PPT (last 24-hrs)

**DECOMPOSITION CODES<sup>2</sup>:**

 Fresh Moderate Complete  
 Early Advanced Scavenged

% VEG. COVER	VEG. HEIGHT	VISIBILITY CLASS <sup>4</sup>
≥ 90% bare ground	≤ 15cm tall	Class 1 (Easy)
≥ 25% bare ground	≤ 15cm tall	Class 2 (Moderate)
≤ 25% bare ground	≤ 25% > 30cm tall	Class 3 (Difficult)
Little/no bare ground	≥ 25% > 30cm tall	Class 4 (Very difficult)

Turbine No.	Area (m <sup>2</sup> )	Start Time	End Time	Duration	Species	Sex (m/f/u)	Bat Forearm <sup>1</sup> (mm)	UTM Coordinates		Decomposition Code <sup>2</sup>	Est. Hours Since Death	Injury <sup>3</sup> Sustained	Distance from Turbine (m)	Direction from Turbine	Substrate	Visibility Class <sup>4</sup>	Photo #
								Zone	Easting								
17	7854	10:35	11:15	40min	—			E	N								
19	6411	11:25	12:05	40min	small bird	U	-	E044	N476	early	2-3days	none visible	NE	33	ground	1	2
20	7854	12:20	13:10	50min	heavy bat	U	53.62	E044	N476	Fresh	24h	none visible	S	39	ground	1	1
					big brown bat		47.37	E044	N476	fresh	24h	none visible	NW	13	ground	1	2
22	85267	13:20	13:55	35min	—			E	N								
27	7432	14:00	14:30	30min	—			E	N								
								E	N								
								E	N								
								E	N								
								E	N								
								E	N								

1 See bat forearm diagram on reverse of page.

3 INJURY TYPES: None Visible / Broken Limb / Broken Neck / Broken Wing / Cut in Half / Decapitated / Head Injury / Severed Wing / Wound to Abdomen

 PAGE 2 OF 12

 Print Name & Initial: Ken Edwards KE  
 (field notes author)

 Quality Control: \_\_\_\_\_ This form is complete  & legible 

 Print Name & Initial: Anna Corrigan AC  
 (field notes QA/QC personnel)

### Mortality Survey Observation Form

 Project No: 160961010

 Project Name: Adelaide Wind Farm

 Date: Aug 13, 2015

 Personnel: Ken Edwards

 Start/End Time: 8:40 / 4:25

 Weather Conditions: 15-25 3km/h / 1.5  
 TEMP (°C) WIND speed/direction

30% CLOUD  
Ø PPT  
Ø PPT (last 24-hrs)

**DECOMPOSITION CODES<sup>2</sup>:**

 Fresh Moderate Complete  
 Early Advanced Scavenged

% VEG. COVER	VEG. HEIGHT	VISIBILITY CLASS <sup>4</sup>
≥ 90% bare ground	≤ 15cm tall	Class 1 (Easy)
≥ 25% bare ground	≤ 15cm tall	Class 2 (Moderate)
≤ 25% bare ground	≤ 25% > 30cm tall	Class 3 (Difficult)
Little/no bare ground	≥ 25% > 30cm tall	Class 4 (Very difficult)

Turbine No.	Area (m <sup>2</sup> )	Start Time	End Time	Duration	Species	Sex (m/f/u)	Bat Forearm <sup>1</sup> (mm)	UTM Coordinates			Decomposition Code <sup>2</sup>	Est. Hours Since Death	Injury <sup>3</sup> Sustained	Distance from Turbine (m)	Direction from Turbine	Substrate	Visibility Class <sup>4</sup>	Photo #
								Zone	Easting	Northing								
6	6524	8:40	9:25	45 min	—			E	N									
7	6629	9:35	10:20	45 min	—			E	N									
11	2436	10:25	11:00	35 min	Hoary bat	/	/	17T	E 644 9154	N 476 3621	-TESTER CARCASS-	2	S	gravel	1	/		
12	6895	11:10	11:40	30 min	—			E	N									
14	3925	11:50	12:20	30 min	—			E	N									
17	7854	12:50	1:20	30 min	—			E	N									
19	6411	1:30	2:10	40 min	—			E	N									
20	7854	2:20	2:50	30 min	—			E	N									
22	5267	3:00	3:30	30 min	Hoary bat	/	/	17T	E 643 8322	N 476 3221	-TESTER CARCASS-	16	NW	gravel	1	/		
27	432	3:40	4:10	30 min	—			E	N									
								E	N									

<sup>1</sup> See bat forearm diagram on reverse of page.

<sup>3</sup> INJURY TYPES: None Visible / Broken Limb / Broken Neck / Broken Wing / Cut in Half / Decapitated / Head Injury / Severed Wing / Wound to Abdomen

 PAGE 1 OF 1

 Print Name & Initial: Ken Edwards KE  
 (field notes author)

Quality Control:

 This form is complete  & legible 

 Print Name & Initial: Anna Corrigan  
 (field notes QA/QC personnel)

**Mortality Survey  
Observation Form**

Project No: 160961010

Project Name: Adelaide Wind Farm

Date: Aug 17, 2015

Personnel: Ken Edwards

Start/End Time: 8:48 / 15:40

Weather Conditions: 25-30 11kph / SW

CLOUD 0 PPT 0 PPT (last 24-hrs) 0

DECOMPOSITION CODES<sup>2</sup>:  
Fresh Moderate Complete  
Early Advanced Scavenged

% VEG. COVER	VEG. HEIGHT	VISIBILITY CLASS <sup>4</sup>
≥ 90% bare ground	≤ 15cm tall	Class 1 (Easy)
≥ 25% bare ground	≤ 15cm tall	Class 2 (Moderate)
≤ 25% bare ground	≤ 25% > 30cm tall	Class 3 (Difficult)
Little/no bare ground	≥ 25% > 30cm tall	Class 4 (Very difficult)

speed/direction

Turbine No.	Area (m <sup>2</sup> )	Start Time	End Time	Duration	Species	Sex (m/f/u)	Bat Forearm <sup>1</sup> (mm)	UTM Coordinates		Decomposition Code <sup>2</sup>	Est. Hours Since Death	Injury <sup>3</sup> Sustained	Distance from Turbine (m)	Direction from Turbine	Substrate	Visibility Class <sup>4</sup>	Photo #
								Zone	Easting								
6	6524	8:45	9:20	35min	—			E	N								
7	629	9:30	10:00	30min	—			E	N								
11	2436	10:05	10:35	30min	—			E	N								
14	3825	10:58	11:20	30min	—			E	N								
17	7884	11:30	12:20	50min	Eastern red	U	4.51	E044 174521	N476 5065	Moderate	3-4 days	none visible	16	E	gravel	1	2
19	7884	12:45	13:10	30min	—			E	N								
20	7884	13:20	13:50	30min	—			E	N								
22	5267	14:00	14:30	30min	—			E	N								
24	7432	14:40	15:10	30min	—			E	N								
12	maintenance																
								E	N								
								E	N								

<sup>1</sup> See bat forearm diagram on reverse of page.

<sup>3</sup> INJURY TYPES: None Visible / Broken Limb / Broken Neck / Broken Wing / Cut in Half / Decapitated / Head Injury / Severed Wing / Wound to Abdomen

PAGE 1 OF 1

Print Name & Initial: Ken Edwards KE  
(field notes author)

Quality Control: This form is complete  & legible

Print Name & Initial: Anna Curmigan AC  
(field notes QA/QC personnel)



**Mortality Survey  
Observation Form**

Project No: 160961010 Project Name: Adelaide Wind Farm  
 Date: Aug 20, 2015 Personnel: Ken Edwards  
 Start/End Time: 8:35 / 15:00

Weather Conditions: 19 14kph / W 100% light yes  
 TEMP (°C) WIND CLOUD PPT PPT (last 24-hrs)  
 speed/direction

**DECOMPOSITION CODES<sup>2</sup>:**  
 Fresh Moderate Complete  
 Early Advanced Scavenged

% VEG. COVER	VEG. HEIGHT	VISIBILITY CLASS <sup>4</sup>
≥ 90% bare ground	≤ 15cm tall	Class 1 (Easy)
≥ 25% bare ground	≤ 15cm tall	Class 2 (Moderate)
≤ 25% bare ground	≤ 25% > 30cm tall	Class 3 (Difficult)
Little/no bare ground	≥ 25% > 30cm tall	Class 4 (Very difficult)

Turbine No.	Area (m <sup>2</sup> )	Start Time	End Time	Duration	Species	Sex (m/f/u)	Bat Forearm <sup>1</sup> (mm)	UTM Coordinates		Decomposition Code <sup>2</sup>	Est. Hours Since Death	Injury <sup>3</sup> Sustained	Distance from Turbine (m)	Direction from Turbine	Substrate	Visibility Class <sup>4</sup>	Photo #
								Zone	Easting								
6	6524	8:35	9:10	35min	hoary	/	/	17T	E045 1973	N476 2637	- TEST CARCASS -	25	NW	soy	2	/	
7	6629	9:20	9:50	30min	-			E		N							
11	2436	10:00	10:35	35min	med. bird	/	/	17T	E044 9169	N476 3625	- TEST CARCASS -	21	NE	soy	2	/	
12	<del>6895</del> 6895	10:40	11:15	35min	med. bird	/	/	17T	E044 7868	N476 3348	- TEST CARCASS -	15	SW	gravel	1	/	
14	3925	11:20	11:50	30min	-			E		N							
17	7854	12:00	12:35	35min	-			E		N							
20	7854	12:55	13:35	40min	-			E		N							
22	5267	13:45	14:15	30min	-			E		N							
27	7432	14:25	15:00	35min	-			E		N							
19	blocked / road maintenance																

1 See bat forearm diagram on reverse of page.

3 INJURY TYPES: None Visible / Broken Limb / Broken Neck / Broken Wing / Cut in Half / Decapitated / Head Injury / Severed Wing / Wound to Abdomen

PAGE 1 OF 1

Print Name & Initial: Ken Edwards KE  
 (field notes author)

Quality Control: Anna Comigan AC This form is complete  & legible   
 Print Name & Initial: Anna Comigan AC  
 (field notes QA/QC personnel)



## Mortality Survey Observation Form

 Project No: 10961010

 Project Name: Adelaide Wind Farm

 Date: Aug 24, 2015

 Personnel: Ken Edwards

 Start/End Time: 8:35 / 16:30

 Weather Conditions: 15 11km/h W ☉ ☉ light  
 TEMP (°C) WIND CLOUD PPT PPT (last 24-hrs)  
 speed/direction

**DECOMPOSITION CODES<sup>2</sup>:**

 Fresh      Moderate      Complete  
 Early      Advanced      Scavenged

% VEG. COVER	VEG. HEIGHT	VISIBILITY CLASS <sup>4</sup>
≥ 90% bare ground	≤ 15cm tall	Class 1 (Easy)
≥ 25% bare ground	≤ 15cm tall	Class 2 (Moderate)
≤ 25% bare ground	≤ 25% > 30cm tall	Class 3 (Difficult)
Little/no bare ground	≥ 25% > 30cm tall	Class 4 (Very difficult)

Turbine No.	Area (m <sup>2</sup> )	Start Time	End Time	Duration	Species	Sex (m/f/u)	Bat Forearm <sup>1</sup> (mm)	UTM Coordinates		Decomposition Code <sup>2</sup>	Est. Hours Since Death	Injury <sup>3</sup> Sustained	Distance from Turbine (m)	Direction from Turbine	Substrate	Visibility Class <sup>4</sup>	Photo #
								Zone	Easting								
6	6524	8:35	9:15	40min	—			E	N								
7	7173	9:25	10:15	50min	—			E	N								
11	2436	10:25	11:05	40min	hoary	U	58.9	17T	E044 9157	N476 3628	Fresh	24hrs	none visible	7	NW	gravel	1 1
12	6895	11:15	11:50	35min				E	N								
14	3925	12:00	12:30	30min				E	N								
17	7854	13:00	13:55	55min	big brown	U	40.88	17T	E044 4505	N476 5113	adv.	1-2 days	none visible	46	NW	ground	1 3
19	7854	14:05	15:05	1hr	big brown	U	44.51	17T	E044 2945	N476 4987	early	3 days	none visible	18	NE	ground	1 1
22	5267	15:15	15:50	35min				E	N								
27	7432	16:00	16:30	30min				E	N								
20	farming activities																
								E	N								

1 See bat forearm diagram on reverse of page.

3 INJURY TYPES: None Visible / Broken Limb / Broken Neck / Broken Wing / Cut in Half / Decapitated / Head Injury / Severed Wing / Wound to Abdomen

 PAGE 1 OF 1

 Print Name & Initial: Ken Edwards KE  
 (field notes author)

Quality Control:

 Print Name & Initial: Anna Carigan AC  
 (field notes QA/QC personnel)

 This form is complete  & legible



### Mortality Survey Observation Form

Project No: 160961010  
 Date: Aug 27, 2015  
 Start/End Time: 8:35 / 1600

Project Name: Adelaide Wind Farm  
 Personnel: Ken Edwards

Weather Conditions: 14 6km/h W 90% no light  
 TEMP (°C) WIND CLOUD PPT PPT (last 24-hrs)  
 speed/direction

DECOMPOSITION CODES<sup>2</sup>:  
 Fresh Moderate Complete  
 Early Advanced Scavenged

% VEG. COVER	VEG. HEIGHT	VISIBILITY CLASS <sup>4</sup>
≥ 90% bare ground	≤ 15cm tall	Class 1 (Easy)
≥ 25% bare ground	≤ 15cm tall	Class 2 (Moderate)
≤ 25% bare ground	≤ 25% > 30cm tall	Class 3 (Difficult)
Little/no bare ground	≥ 25% > 30cm tall	Class 4 (Very difficult)

Turbine No.	Area (m <sup>2</sup> )	Start Time	End Time	Duration	Species	Sex (m/f/u)	Bat Forearm <sup>1</sup> (mm)	UTM Coordinates			Decomposition Code <sup>2</sup>	Est. Hours Since Death	Injury <sup>3</sup> Sustained	Distance from Turbine (m)	Direction from Turbine	Substrate	Visibility Class <sup>4</sup>	Photo #	
								Zone	Easting	Northing									
6	6524	8:35	9:00	35min	med. bird	/	/	17T	E045	N476	1993	2589	- TEST CARCASS -	19	SE	/	2	/	
11	2436	9:25	10:10	45min	hoary bat small	U	57.1	17T	E044	N476	9149	6329	fresh < 2hrs	none visible	8	NE	soy	2	1
					bird	/	/	17T	E044	N476	9148	6330	- TEST CARCASS -	1	N	/	1	/	
12	6895	10:15	10:45	30min	-	/	/	17T	E044	N476	7128	4831	- TEST CARCASS -	24	S	grass	2	/	
14	3925	10:55	11:40	45min	hoary bat	/	/	17T	E044	N476	7165	4831	- TEST CARCASS -	24	S	grass	2	/	
17	7854	11:50	12:20	30min	-	/	/		E	N									
19	7854	12:35	13:05	30min	-	/	/		E	N									
20	5267	13:15	13:50	35min	-	/	/		E	N									
22	7432	14:00	14:35	35min	-	/	/		E	N									
7	7173	14:55	15:40	45min	-	/	/		E	N									
27	maintenance				-	/	/		E	N									

1 See bat forearm diagram on reverse of page.

3 INJURY TYPES: None Visible / Broken Limb / Broken Neck / Broken Wing / Cut in Half / Decapitated / Head Injury / Severed Wing / Wound to Abdomen

PAGE 1 OF 1

Print Name & Initial: Ken Edwards KE

(field notes author)

Quality Control:

Print Name & Initial: Anna Comyn AC

(field notes QA/QC personnel)

This form is complete  & legible



### Mortality Survey Observation Form

Project No: 160961010 Project Name: Adelaide Wind Farm  
 Date: Aug 31, 2015 Personnel: Ken Edwards  
 Start/End Time: 8:40 / 116:45

Weather Conditions: 20 3 / SW 60% Ø Ø  
 TEMP (°C) WIND speed/direction CLOUD PPT PPT (last 24-hrs)

DECOMPOSITION CODES:  
 Fresh Moderate Complete  
 Early Advanced Scavenged

% VEG. COVER	VEG. HEIGHT	VISIBILITY CLASS <sup>4</sup>
≥ 90% bare ground	≤ 15cm tall	Class 1 (Easy)
≥ 25% bare ground	≤ 15cm tall	Class 2 (Moderate)
≤ 25% bare ground	≤ 25% > 30cm tall	Class 3 (Difficult)
Little/no bare ground	≥ 25% > 30cm tall	Class 4 (Very difficult)

Turbine No.	Area (m <sup>2</sup> )	Start Time	End Time	Duration	Species	Sex (m/f/u)	Bat Forearm <sup>1</sup> (mm)	UTM Coordinates		Decomposition Code <sup>2</sup>	Est. Hours Since Death	Injury <sup>3</sup> Sustained	Distance from Turbine (m)	Direction from Turbine	Substrate	Visibility Class <sup>4</sup>	Photo #	
								Zone	Easting									Northing
6	6524	8:40	9:20	40min	Hoary	U	58.87	17T	E 045 1976	N 476 2602	fresh	<24	head injury	3	W	grass	2	1
<del>6</del>	<del>6524</del>	<del>8:40</del>	<del>9:20</del>	<del>40min</del>	Hoary	U	53.11	17T	E 045 1977	N 476 2606	Fresh	<24	none visible	10	SW	gravel	1	1
7	7173	9:35	10:10	35min	—				E	N								
11	2436	10:20	10:50	30min	—				E	N								
12	6895	11:00	12:00	1hr	Hoary	U	55.37	17T	E 044 7887	N 476 3391	Fresh	<24	none visible	31	NE	ground	1	1
14	3925	12:10	12:45	35min	Big Brown	U	45.97	17T	E 044 7170	N 476 4853	fresh	12 days	Broken limb	3	SE	ground	1	1
17	7854	13:00	13:50	40min	Hoary	U	52.09	17T	E 044 4556	N 476 4090	early	34 days	none visible	48	NE	ground	1	1
19	7854	14:00	14:40	40min	—				E	N								
20	7854	14:50	15:25	35min	—				E	N								
22	5267	15:35	16:05	30min	—				E	N								
27	7432	16:15	16:45	30min	—				E	N								

<sup>1</sup> See bat forearm diagram on reverse of page.

<sup>3</sup> INJURY TYPES: None Visible / Broken Limb / Broken Neck / Broken Wing / Cut in Half / Decapitated / Head Injury / Severed Wing / Wound to Abdomen

PAGE 1 OF 1

Print Name & Initial: Ken Edwards KE  
 (field notes author)

Quality Control:

Print Name & Initial: Anna Carigan AC  
 (field notes QA/QC personnel)

This form is complete  & legible

**Mortality Survey  
Observation Form**

Project No: 160961010 Project Name: Adelaide Wind Farm  
 Date: Sept. 3, 2015 Personnel: Ken Edwards  
 Start/End Time: 8:40 / 15:15

Weather Conditions: 25-38 3 W 100% no no  
 TEMP (°C) WIND CLOUD PPT PPT (last 24-hrs)  
 speed/direction

DECOMPOSITION CODES:  
 Fresh Moderate Complete  
 Early Advanced Scavenged

% VEG. COVER	VEG. HEIGHT	VISIBILITY CLASS <sup>4</sup>
≥ 90% bare ground	≤ 15cm tall	Class 1 (Easy)
≥ 25% bare ground	≤ 15cm tall	Class 2 (Moderate)
≤ 25% bare ground	≤ 25% > 30cm tall	Class 3 (Difficult)
Little/no bare ground	≥ 25% > 30cm tall	Class 4 (Very difficult)

Turbine No.	Area (m <sup>2</sup> )	Start Time	End Time	Duration	Species	Sex (m/f/u)	Bat Forearm <sup>1</sup> (mm)	UTM Coordinates		Decomposition Code <sup>2</sup>	Est. Hours Since Death	Injury <sup>3</sup> Sustained	Distance from Turbine (m)	Direction from Turbine	Substrate	Visibility Class <sup>4</sup>	Photo #	
								Zone	Easting									Northing
6	6524	8:40	10:10	1h30	silver haired	U	39.25	17T	E 045 1965	N 476 2571	moderate	1 week	none visible	~30m	SW	grass/ground	2	1
					silver haired	U	40.89	17T	E 045 1967	N 476 2624	fresh	1-3 days	broken limb	17m	NW	ground	1	1
					big brown	U	45.91	17T	E 045 1974	N 476 2615	early moderate	2-3 days	none visible	7	E	ground/grass	2	1
11	2436	10:25	11:05	40 min	meal. bird	U	-	17T	E 044 9152	N 476 3630	advanced	2-3 wks	none visible	16	N	soy	2/3	1
12	6895	11:15	12:05	45 min	Hoary bat	m	54.75	17T	E 044 7900	N 476 3335	fresh	<24hrs	none visible	39	SE	ground	1	1
14	3925	12:20	12:50	30 min	-	-	-	E	N	-	-	-	-	-	-	-	-	-
17	7554	13:05	14:25	1h20	Hoary Bat	F	50.65	17T	E 044 4551	N 476 5066	fresh	<24	Broken limb	43	E	ground	1	1
					silver haired	U	39.51	17T	E 044 4518	N 476 5051	advanced	2 wks	none visible	17	SE	grass	2	1
					Hoary Bat	U	42.85	17T	E 044 4518	N 476 5050	fresh	<24	none visible	18	S	ground	1	1
					Hoary Bat	-	-	17T	E 044 4507	N 476 5070	-TEST CARCASS	-	-	8	N	grass	2	1
19	7874	14:35	15:10	35 min	Eastern Red	-	-	17T	E 044 2980	N 476 4960	-TEST CARCASS	-	-	39	SE	ground	1	1
7, 20, 22, 27 Not searched - lightning																		

1 See bat forearm diagram on reverse of page.

3 INJURY TYPES: None Visible / Broken Limb / Broken Neck / Broken Wing / Cut in Half / Decapitated / Head Injury / Severed Wing / Wound to Abdomen

PAGE 1 OF 1

Print Name & Initial: Ken Edwards KE  
 (field notes author)

Quality Control:

Print Name & Initial: Anna Corrigan AC  
 (field notes QA/QC personnel)

This form is complete  & legible



## Mortality Survey Observation Form

Project No: 160961010  
 Date: Sept. 7/2015  
 Start/End Time: 8:35 / 1:30

Project Name: Adelaide Wind Farm  
 Personnel: Ken Edwards

Weather Conditions: 26.31 13km/h SW 10% Ø Ø  
 TEMP (°C) WIND speed/direction CLOUD PPT PPT (last 24-hrs)

DECOMPOSITION CODES<sup>2</sup>:  
 Fresh Moderate Complete  
 Early Advanced Scavenged

% VEG. COVER	VEG. HEIGHT	VISIBILITY CLASS <sup>4</sup>
≥ 90% bare ground	≤ 15cm tall	Class 1 (Easy)
≥ 25% bare ground	≤ 15cm tall	Class 2 (Moderate)
≤ 25% bare ground	≤ 25% > 30cm tall	Class 3 (Difficult)
Little/no bare ground	≥ 25% > 30cm tall	Class 4 (Very difficult)

Turbine No.	Area (m <sup>2</sup> )	Start Time	End Time	Duration	Species	Sex (m/f/u)	Bat Forearm <sup>1</sup> (mm)	UTM Coordinates		Decomposition Code <sup>2</sup>	Est. Hours Since Death	Injury <sup>3</sup> Sustained	Distance from Turbine (m)	Direction from Turbine	Substrate	Visibility Class <sup>4</sup>	Photo #
								Zone	Easting								
6	6524	8:35	9:20	45 min	—			E	N								
7	7173	9:30	10:00	30 min	silver haired	U	42.56	HT	E044 9652	N476 2127	Moderate	1-2wks visible	20	SW	grass/ground	1	1
11	2436	10:20	10:50	30 min	—			E	N								
12	6895	11:00	11:35	35 min	—			E	N								
14	3925	11:40	12:10	30 min	—			E	N								
17	7854	12:20	12:50	30 min	—			E	N								
19	7854	12:55	13:25	30 min	silver haired tree swallow	U	42.5	HT	E044 9652	N476 2127	Moderate	1-2wks visible	9	NW	ground	1	1
20	7854	13:40	14:10	30 min	swallow	U	—	HT	E044 9936	N476 2127	Moderate	1-2wks visible	13	NE	ground	1	1
22	5267	14:25	14:55	30 min	—			E	N								
27	7432	15:00	15:30	30 min	—			E	N								

<sup>1</sup> See bat forearm diagram on reverse of page.

<sup>3</sup> INJURY TYPES: None Visible / Broken Limb / Broken Neck / Broken Wing / Cut in Half / Decapitated / Head Injury / Severed Wing / Wound to Abdomen

PAGE 1 OF 1

Print Name & Initial: Ken Edwards KE  
 (field notes author)

Quality Control: This form is complete  & legible

Print Name & Initial: Anna Corrigan AC  
 (field notes QA/QC personnel)



## Mortality Survey Observation Form

Project No: 160961010 Project Name: Abelaide Wind Farm  
 Date: Sept. 10/2015 Personnel: Ken Edwards  
 Start/End Time: 8:30 / 14:35

Weather Conditions: 17-25 6km/h NE 10% no light  
 TEMP (°C) WIND CLOUD PPT PPT (last 24-hrs)  
 speed/direction

DECOMPOSITION CODES<sup>2</sup>:  
 Fresh Moderate Complete  
 Early Advanced Scavenged

% VEG. COVER	VEG. HEIGHT	VISIBILITY CLASS <sup>4</sup>
≥ 90% bare ground	≤ 15cm tall	Class 1 (Easy)
≥ 25% bare ground	≤ 15cm tall	Class 2 (Moderate)
≤ 25% bare ground	≤ 25% > 30cm tall	Class 3 (Difficult)
Little/no bare ground	≥ 25% > 30cm tall	Class 4 (Very difficult)

Turbine No.	Area (m <sup>2</sup> )	Start Time	End Time	Duration	Species	Sex (m/f/u)	Bat Forearm <sup>1</sup> (mm)	UTM Coordinates			Decomposition Code <sup>2</sup>	Est. Hours Since Death	Injury <sup>3</sup> Sustained	Distance from Turbine (m)	Direction from Turbine	Substrate	Visibility Class <sup>4</sup>	Photo #
								Zone	Easting	Northing								
6	6524	8:30	9:00	30min	—			E	N									
7	7173	9:15	9:45	30min	—			E	N									
11	2438	9:50	10:20	30min	—			E	N									
12	6895	10:25	11:05	40min	—			E	N									
14	3725	11:15	11:55	40min	—			E	N									
17	7854	12:00	12:30	30min	—			E	N									
19	7854	12:35	13:05	35min	—			E	N									
20	7894	13:20	13:58	30min	—			E	N									
<del>21</del>								E	N									
27	7432	14:00	14:30	30min	—			E	N									
22	maintenance																	
								E	N									

<sup>1</sup> See bat forearm diagram on reverse of page.

<sup>3</sup> INJURY TYPES: None Visible / Broken Limb / Broken Neck / Broken Wing / Cut in Half / Decapitated / Head Injury / Severed Wing / Wound to Abdomen

PAGE 1 OF 1

Print Name & Initial: Ken Edwards KE  
 (field notes author)

Quality Control:

Print Name & Initial: Anna Conigan AC  
 (field notes QA/QC personnel)

This form is complete  & legible



### Mortality Survey Observation Form

Project No: 160961010

Project Name: Alekhale Wind Farm

Date: Sept. 14/2015

Personnel: Ken Edwards

Start/End Time: 8:35 / 16:00

Weather: 13-22 km/h / SW  
Conditions: TEMP (°C) WIND CLOUD PPT PPT (last 24-hrs)

speed/direction

**DECOMPOSITION CODES<sup>2</sup>:**

Fresh Moderate Complete  
Early Advanced Scavenged

% VEG. COVER	VEG. HEIGHT	VISIBILITY CLASS <sup>4</sup>
≥ 90% bare ground	≤ 15cm tall	Class 1 (Easy)
≥ 25% bare ground	≤ 15cm tall	Class 2 (Moderate)
≤ 25% bare ground	≤ 25% > 30cm tall	Class 3 (Difficult)
Little/no bare ground	≥ 25% > 30cm tall	Class 4 (Very difficult)

Turbine No.	Area (m <sup>2</sup> )	Start Time	End Time	Duration	Species	Sex (m/f/u)	Bat Forearm <sup>1</sup> (mm)	UTM Coordinates		Decomposition Code <sup>2</sup>	Est. Hours Since Death	Injury <sup>3</sup> Sustained	Distance from Turbine (m)	Direction from Turbine	Substrate	Visibility Class <sup>4</sup>	Photo #
								Zone	Easting								
6	2745	8:35	9:05	30min	---			E	N								
7	7173	9:30	10:00	30min	---			E	N								
11	2436	10:10	10:45	35min	---			E	N								
12	6895	10:50	11:20	30min	---			E	N								
14	3925	11:25	11:55	30min	---			E	N								
17	7854	12:25	12:55	30min	---			E	N								
19	7854	13:05	13:35	30min	---			E	N								
20	7854	13:45	14:15	30min	<del>Leary bat</del>	/	/	E043	N476								
22	5267	14:25	14:55	30min	Leary bat	/	/	17T 8310	3206	-TEST CARCASS		4	W	ground	1	/	
27	7432	15:20	15:45	45min	med bird	/	/	E043	N476	-TEST CARCASS		2.3	S	ground	1	/	
								E	N								
								E	N								

<sup>1</sup> See bat forearm diagram on reverse of page.

<sup>3</sup> INJURY TYPES: None Visible / Broken Limb / Broken Neck / Broken Wing / Cut in Half / Decapitated / Head Injury / Severed Wing / Wound to Abdomen

PAGE 1 OF 1

Print Name & Initial: Ken Edwards KE

(field notes author)

Quality Control:

Print Name & Initial: Anna Conigan AC

(field notes QA/QC personnel)

This form is complete  & legible



### Mortality Survey Observation Form

Project No: 160961010  
 Date: Sept. 17/2015  
 Start/End Time: 8:35 11:55

Project Name: Adelaide Wind Farm  
 Personnel: Ken Edwards

Weather Conditions: 15-27 3kall/1SE Ø Ø Ø  
 TEMP (°C) WIND CLOUD PPT PPT (last 24-hrs)  
 speed/direction

DECOMPOSITION CODES:  
 Fresh Moderate Complete  
 Early Advanced Scavenged

% VEG. COVER	VEG. HEIGHT	VISIBILITY CLASS <sup>4</sup>
≥ 90% bare ground	≤ 15cm tall	Class 1 (Easy)
≥ 25% bare ground	≤ 15cm tall	Class 2 (Moderate)
≤ 25% bare ground	≤ 25% > 30cm tall	Class 3 (Difficult)
Little/no bare ground	≥ 25% > 30cm tall	Class 4 (Very difficult)

Turbine No.	Area (m <sup>2</sup> )	Start Time	End Time	Duration	Species	Sex (m/f/u)	Bat Forearm <sup>1</sup> (mm)	UTM Coordinates			Decomposition Code <sup>2</sup>	Est. Hours Since Death	Injury <sup>3</sup> Sustained	Distance from Turbine (m)	Direction from Turbine	Substrate	Visibility Class <sup>4</sup>	Photo #
								Zone	Easting	Northing								
6	2745	8:35	9:10	35min	mod. bat	/	/	17T	E 045 1999	N 476 2620	-TEST CARCASS-	16	NE	grass	2	/		
7	7173	9:20	10:00	40min	—				E	N								
11	2436	10:16	10:40	30min	—				E	N								
12	6895	10:55	11:30	35min	—				E	N								
14	3925	11:50	12:25	35min	hoary bat	/	/	17T	E 044 7190	N 476 4858	-TEST CARCASS-	19	E	soy	2	/		
17	7854	12:55	13:40	45min	—				E	N								
19	7854	13:45	14:15	30min	—				E	N								
20	7854	14:15	14:45	30min	—				E	N								
22	5267	14:50	15:20	30min	—				E	N								
27	7432	15:25	15:55	30min	—				E	N								

<sup>1</sup> See bat forearm diagram on reverse of page.

<sup>3</sup> INJURY TYPES: None Visible / Broken Limb / Broken Neck / Broken Wing / Cut in Half / Decapitated / Head Injury / Severed Wing / Wound to Abdomen

PAGE 1 OF 1

Print Name & Initial: Ken Edwards

(field notes author)

Quality Control:

Print Name & Initial: Anna Conigan

(field notes QA/QC personnel)

This form is complete  & legible



## Mortality Survey Observation Form

Project No: 160961010  
 Date: Sept 21/2015  
 Start/End Time: 8:30 / 17:05

Project Name: Adelaide Wind Farm  
 Personnel: Ken Edwards

Weather Conditions: 17 14km/h E 0 0 0  
 TEMP (°C) WIND CLOUD PPT PPT (last 24-hrs)  
 speed/direction

DECOMPOSITION CODES<sup>2</sup>:  
 Fresh Moderate Complete  
 Early Advanced Scavenged

% VEG. COVER	VEG. HEIGHT	VISIBILITY CLASS <sup>4</sup>
≥ 90% bare ground	≤ 15cm tall	Class 1 (Easy)
≥ 25% bare ground	≤ 15cm tall	Class 2 (Moderate)
≤ 25% bare ground	≤ 25% > 30cm tall	Class 3 (Difficult)
Little/no bare ground	≥ 25% > 30cm tall	Class 4 (Very difficult)

Turbine No.	Area (m <sup>2</sup> )	Start Time	End Time	Duration	Species	Sex (m/f/u)	Bat Forearm <sup>1</sup> (mm)	UTM Coordinates		Decomposition Code <sup>2</sup>	Est. Hours Since Death	Injury <sup>3</sup> Sustained	Distance from Turbine (m)	Direction from Turbine	Substrate	Visibility Class <sup>4</sup>	Photo #
								Zone	Easting								
6	2745	8:30	9:00	30min	—			E	N								
7	7173	9:05	9:45	40min	—			E	N								
12	6895	9:55	10:35	40min	—			E	N								
14	3925	10:50	11:30	40min	—			E	N								
17	7854	11:40	12:10	30min	—			E	N								
19	7854	12:35	13:15	40min	—			E	N								
20	7854	13:25	13:55	30min	—			E	N								
22	5267	14:05	14:35	30min	—			E	N								
TEST 27	7432	14:45	15:05	30min	—	/	/	E 17T	N 476	EG43 5960	5459	-TESTER CARCASS	-3	S	gravel	1	/
11	2432	15:20	15:50	30min	—			E	N								
R 21	7854	16:15	17:05	50min	—			E	N								

<sup>1</sup> See bat forearm diagram on reverse of page.

<sup>3</sup> INJURY TYPES: None Visible / Broken Limb / Broken Neck / Broken Wing / Cut in Half / Decapitated / Head Injury / Severed Wing / Wound to Abdomen

PAGE 1 OF 1

Print Name & Initial: Ken Edwards  
 (field notes author)

Quality Control:

Print Name & Initial: Anna Cornigan  
 (field notes QA/QC personnel)

This form is complete  & legible



## Mortality Survey Observation Form

Project No: 160961016  
 Date: Sept. 24/2015  
 Start/End Time: 8:50 / 16:00

Project Name: Adelaide Wind Farm  
 Personnel: Ken Edwards

Weather Conditions: 16-24 11km/h E Ø Ø Ø  
 TEMP (°C) WIND CLOUD PPT PPT (last 24-hrs)  
 speed/direction

### DECOMPOSITION CODES<sup>2</sup>:

Fresh Moderate Complete  
 Early Advanced Scavenged

% VEG. COVER	VEG. HEIGHT	VISIBILITY CLASS <sup>4</sup>
≥ 90% bare ground	≤ 15cm tall	Class 1 (Easy)
≥ 25% bare ground	≤ 15cm tall	Class 2 (Moderate)
≤ 25% bare ground	≤ 25% > 30cm tall	Class 3 (Difficult)
Little/no bare ground	≥ 25% > 30cm tall	Class 4 (Very difficult)

Turbine No.	Area (m <sup>2</sup> )	Start Time	End Time	Duration	Species	Sex (m/f/u)	Bat Forearm <sup>1</sup> (mm)	UTM Coordinates		Decomposition Code <sup>2</sup>	Est. Hours Since Death	Injury <sup>3</sup> Sustained	Distance from Turbine (m)	Direction from Turbine	Substrate	Visibility Class <sup>4</sup>	Photo #
								Zone	Easting								
6	27458	8:50	9:20	30min	—			E	N								
7	7173	9:30	10:00	30min	—			E	N								
11	2436	10:05	10:35	30min	—			E	N								
14	3925	10:50	11:20	30min	—			E	N								
17	7854	11:45	12:20	35min	—			E	N								
19	7854	12:30	13:00	30min	—			E	N								
22	5267	13:10	13:40	30min	—			E	N								
27	<del>7854</del>	13:50	14:30	40min	—			E	N								
20	7854	14:40	15:10	30min	silver haired	U	43.0217T	E044 0286	N 476 5199	fresh	1-2 days	<del>broken wing</del> broken wing	37	SE	ground	1	1
12	6895	15:20	15:50	30min	—			E	N								
								E	N								

<sup>1</sup> See bat forearm diagram on reverse of page.

<sup>3</sup> INJURY TYPES: None Visible / Broken Limb / Broken Neck / Broken Wing / Cut in Half / Decapitated / Head Injury / Severed Wing / Wound to Abdomen

PAGE 1 OF 1

Print Name & Initial: Ken Edwards KE  
 (field notes author)

Quality Control:

Print Name & Initial: Anna Corrigan AC  
 (field notes QA/QC personnel)

This form is complete  & legible

### Mortality Survey Observation Form

Project No: 160961016 Project Name: Adelaide Wind Farm  
 Date: Sept. 28/2015 Personnel: Ken Edwards  
 Start/End Time: 8:35 / 16:30

Weather Conditions: 12-24 14km/h 15W 100% Ø Ø  
 TEMP (°C) WIND speed/direction CLOUD PPT PPT (last 24-hrs)

DECOMPOSITION CODES:  
 Fresh Moderate Complete  
 Early Advanced Scavenged

% VEG. COVER	VEG. HEIGHT	VISIBILITY CLASS <sup>4</sup>
≥ 90% bare ground	≤ 15cm tall	Class 1 (Easy)
≥ 25% bare ground	≤ 15cm tall	Class 2 (Moderate)
≤ 25% bare ground	≤ 25% > 30cm tall	Class 3 (Difficult)
Little/no bare ground	≥ 25% > 30cm tall	Class 4 (Very difficult)

Turbine No.	Area (m <sup>2</sup> )	Start Time	End Time	Duration	Species	Sex (m/f/u)	Bat Forearm <sup>1</sup> (mm)	UTM Coordinates		Decomposition Code <sup>2</sup>	Est. Hours Since Death	Injury <sup>3</sup> Sustained	Distance from Turbine (m)	Direction from Turbine	Substrate	Visibility Class <sup>4</sup>	Photo #
								Zone	Easting								
7	7175	8:35	9:15	40min	—			E	N								
6	6175	9:25	10:05	40min	—			E	N								
11	2436	10:15	10:55	40min	—			E	N								
12	7854	11:15	11:55	40min	—			E	N								
14	3925	12:25	13:00	35min	—			E	N								
17	7854	13:10	13:50	40min	Eastern Reed	/	/	17T E044 4515	N476 5066	- TESTER CARCASS	-6	NE	gravel	1	/		
19	7854	13:55	14:30	35min	sm. bird	/	/	17T E044 2939	N476 4969	- TESTER CARCASS	-15	NW	ground	1	/		
20	7854	14:40	15:10	30min	—			E	N								
22	5267	15:15	15:45	30min	Large bird	/	/	17T E043 8316	N476 3185	- TESTER CARCASS	-20	S	grass	2	/		
27	7854	15:55	16:25	30min	—			E	N								
								E	N								
								E	N								

<sup>1</sup> See bat forearm diagram on reverse of page.

<sup>3</sup> INJURY TYPES: None Visible / Broken Limb / Broken Neck / Broken Wing / Cut in Half / Decapitated / Head Injury / Severed Wing / Wound to Abdomen

PAGE 1 OF 1

Print Name & Initial: Ken Edwards *KE*  
 (field notes author)

Quality Control:

Print Name & Initial: Anna Carigan *AC*  
 (field notes QA/QC personnel)

This form is complete  & legible

### Mortality Survey Observation Form

Project No: 160961010 Project Name: Adelaide Wind Farm  
 Date: Oct. 1/2015 Personnel: Ken Edwards  
 Start/End Time: 8:40 / 16:35

Weather Conditions: 8-15 16km/h NE 20% Ø Ø  
 TEMP (°C) WIND CLOUD PPT PPT (last 24-hrs)  
 speed/direction

DECOMPOSITION CODES<sup>2</sup>:  
 Fresh Moderate Complete  
 Early Advanced Scavenged

% VEG. COVER	VEG. HEIGHT	VISIBILITY CLASS <sup>4</sup>
≥ 90% bare ground	≤ 15cm tall	Class 1 (Easy)
≥ 25% bare ground	≤ 15cm tall	Class 2 (Moderate)
≤ 25% bare ground	≤ 25% > 30cm tall	Class 3 (Difficult)
Little/no bare ground	≥ 25% > 30cm tall	Class 4 (Very difficult)

Turbine No.	Area (m <sup>2</sup> )	Start Time	End Time	Duration	Species	Sex (m/f/u)	Bat Forearm <sup>1</sup> (mm)	UTM Coordinates		Decomposition Code <sup>2</sup>	Est. Hours Since Death	Injury <sup>3</sup> Sustained	Distance from Turbine (m)	Direction from Turbine	Substrate	Visibility Class <sup>4</sup>	Photo #
								Zone	Easting								
6	2745	8:40	9:20	40min	—			E	N								
7	7173	9:30	10:05	35min	—			E	N								
11	2436	10:15	10:50	35min	—			E	N								
12	6895	11:00	11:40	40min	—			E	N								
14	3925	12:00	12:35	35min	—			E	N								
17	7854	12:45	13:20	35min	—			E	N								
19	7894	13:30	14:00	30min	—			E	N								
20	7854	14:10	14:40	30min	overbird	U	—	17T	E <sup>0444</sup> 0282	N <sup>476</sup> 5189	fresh	24hrs	none visible	40	SE	ground	1 2
22	5267	15:05	15:40	35min	—			E	N								
27	7854	15:50	16:30	40min	—			E	N								
								E	N								
								E	N								

<sup>1</sup> See bat forearm diagram on reverse of page.

<sup>3</sup> INJURY TYPES: None Visible / Broken Limb / Broken Neck / Broken Wing / Cut in Half / Decapitated / Head Injury / Severed Wing / Wound to Abdomen

PAGE 1 OF 1

Print Name & Initial: Ken Edwards *KE*  
 (field notes author)

Quality Control: \_\_\_\_\_ This form is complete  & legible

Print Name & Initial: Anna Corrigan *AC*  
 (field notes QA/QC personnel)

**Mortality Survey  
Observation Form**

Project No: 160961010 Project Name: Adelaide Wind Farm  
 Date: Oct 5/2015 Personnel: Ken Edwards  
 Start/End Time: 8:35 16:20

Weather Conditions: 12 6km/h / NE 60% light yes  
 TEMP (°C) WIND speed/direction CLOUD RPT PPT (last 24-hrs)

DECOMPOSITION CODES:  
 Fresh Moderate Complete  
 Early Advanced Scavenged

% VEG. COVER	VEG. HEIGHT	VISIBILITY CLASS <sup>4</sup>
≥ 90% bare ground	≤ 15cm tall	Class 1 (Easy)
≥ 25% bare ground	≤ 15cm tall	Class 2 (Moderate)
≤ 25% bare ground	≤ 25% > 30cm tall	Class 3 (Difficult)
Little/no bare ground	≥ 25% > 30cm tall	Class 4 (Very difficult)

Turbine No.	Area (m <sup>2</sup> )	Start Time	End Time	Duration	Species	Sex (m/f/u)	Bat Forearm <sup>1</sup> (mm)	UTM Coordinates		Decomposition Code <sup>2</sup>	Est. Hours Since Death	Injury <sup>3</sup> Sustained	Distance from Turbine (m)	Direction from Turbine	Substrate	Visibility Class <sup>4</sup>	Photo #
								Zone	Easting								
7	7173	8:35	9:15	40min	—			E	N								
6	7854	9:25	10:00	35min	med bird	/	/	17T	E 045 2007	N 476 2610	-TEST CARCASS	—	20	NE	ground	1	/
#11	7854	10:15	10:50	35min	—			E	N								
12	7854	11:00	11:30	30min	—			E	N								
14	3925	11:35	12:05	30min	med. bird	/	/	17T	E 044 7170	N 476 4860	-TEST CARCASS	—	7	N	grass	2	/
17	7854	12:35	13:15	40min	—			E	N								
19	7854	13:35	13:55	30min	—			E	N								
20	7854	14:05	14:40	35min	—			E	N								
22		14:50	15:25	35min	—			E	N								
27	7854	15:35	16:15	40min	—			E	N								
								E	N								

1 See bat forearm diagram on reverse of page.  
 3 INJURY TYPES: None Visible / Broken Limb / Broken Neck / Broken Wing / Cut in Half / Decapitated / Head Injury / Severed Wing / Wound to Abdomen

PAGE 1 OF 1  
 Print Name & Initial: Ken Edwards  
 (field notes author)

Quality Control: \_\_\_\_\_ This form is complete  & legible   
 Print Name & Initial: Anna Corrigan  
 (field notes QA/QC personnel)

**Mortality Survey  
Observation Form**

Project No: 160961010  
Date: Oct 8/2015  
Start/End Time: 8:45 / 16:30

Project Name: Adelaide Wind Farm  
Personnel: Ken Edwards

Weather Conditions: 14 8 km/h / SE 30% Ø Ø  
TEMP (°C) WIND CLOUD PPT PPT (last 24-hrs)  
speed/direction

DECOMPOSITION CODES<sup>2</sup>:  
Fresh Moderate Complete  
Early Advanced Scavenged

% VEG. COVER	VEG. HEIGHT	VISIBILITY CLASS <sup>4</sup>
≥ 90% bare ground	≤ 15cm tall	Class 1 (Easy)
≥ 25% bare ground	≤ 15cm tall	Class 2 (Moderate)
≤ 25% bare ground	≤ 25% > 30cm tall	Class 3 (Difficult)
Little/no bare ground	≥ 25% > 30cm tall	Class 4 (Very difficult)

Turbine No.	Area (m <sup>2</sup> )	Start Time	End Time	Duration	Species	Sex (m/f/u)	Bat Forearm <sup>1</sup> (mm)	UTM Coordinates		Decomposition Code <sup>2</sup>	Est. Hours Since Death	Injury <sup>3</sup> Sustained	Distance from Turbine (m)	Direction from Turbine	Substrate	Visibility Class <sup>4</sup>	Photo #
								Zone	Easting								
7	7173	8:45	9:15	30min	—			E	N								
6	7854	9:20	9:50	30min	—			E	N								
11	7854	10:00	10:35	35min	—			E	N								
12	7854	10:45	11:30	45min	—			E	N								
14	3925	11:35	12:10	35min	—			E	N								
17	7854	12:35	13:15	40min	—			E	N								
19	7854	13:20	13:55	35min	—			E	N								
20	7854	14:10	14:50	40min	golden crowned Kinglet	U	—	17T E 044 0230	N 476 5190	fresh	<24	none visible	40	SW	ground	1	1
22	5267	15:10	15:50	40min	—			E	N								
27	7854	16:00	16:30	30min	—			E	N								
								E	N								
								E	N								

<sup>1</sup> See bat forearm diagram on reverse of page.

<sup>3</sup> INJURY TYPES: None Visible / Broken Limb / Broken Neck / Broken Wing / Cut in Half / Decapitated / Head Injury / Severed Wing / Wound to Abdomen

PAGE 1 OF 1

Print Name & Initial: Ken Edwards KE  
(field notes author)

Quality Control:

Print Name & Initial: Anna Corrigan  
(field notes QA/QC personnel)

This form is complete  & legible



## Mortality Survey Observation Form

Project No: 160961010  
 Date: Oct 12/2015  
 Start/End Time: 8:40 / 16:05

Project Name: Adelaide Wind Farm  
 Personnel: Ken Edwards

Weather Conditions: 18 23 5 Ø Ø Ø  
 TEMP (°C) WIND CLOUD PPT PPT (last 24-hrs)  
speed/direction

DECOMPOSITION CODES:  
 Fresh Moderate Complete  
 Early Advanced Scavenged

% VEG. COVER	VEG. HEIGHT	VISIBILITY CLASS <sup>4</sup>
≥ 90% bare ground	≤ 15cm tall	Class 1 (Easy)
≥ 25% bare ground	≤ 15cm tall	Class 2 (Moderate)
≤ 25% bare ground	≤ 25% > 30cm tall	Class 3 (Difficult)
Little/no bare ground	≥ 25% > 30cm tall	Class 4 (Very difficult)

Turbine No.	Area (m <sup>2</sup> )	Start Time	End Time	Duration	Species	Sex (m/f/u)	Bat Forearm <sup>1</sup> (mm)	UTM Coordinates		Decomposition Code <sup>2</sup>	Est. Hours Since Death	Injury <sup>3</sup> Sustained	Distance from Turbine (m)	Direction from Turbine	Substrate	Visibility Class <sup>4</sup>	Photo #
								Zone	Easting								
7	7854	8:45	9:15	35min	—			E	N								
6	7854	9:30	10:05	35min	—			E	N								
11	7854	10:15	10:55	40min	—			E	N								
12	7854	11:05	11:45	40min	—			E	N								
14	4712	12:10	12:45	35min	—			E	N								
17	7854	13:00	13:30	30min	—			E	N								
19	7854	13:40	14:10	30min	—			E	N								
22	5267	14:30	15:00	30min	—			E	N								
27	7854	15:10	15:50	40min	hoary bat	U	52.01	17T 5939	N 476 5477	advanced	2-3wks	none visible	35	NW	grass/ground	2	1
					Eastern Red	U	42.35	17T 5943	N 476 5463	advanced	"	"	25	W	"	2	1
20					farming-working ground												

<sup>1</sup> See bat forearm diagram on reverse of page.

<sup>3</sup> INJURY TYPES: None Visible / Broken Limb / Broken Neck / Broken Wing / Cut in Half / Decapitated / Head Injury / Severed Wing / Wound to Abdomen

PAGE 1 OF 1

Print Name & Initial: Ken Edwards KE  
(field notes author)

Quality Control:

Print Name & Initial: Anna Corrigan  
(field notes QA/QC personnel)

This form is complete  & legible





# Mortality Survey Observation Form

Project No: 160961010  
 Date: 4 Oct 15/2015  
 Start/End Time: 8:40 / 16:40

Project Name: Adebiade Wind Farm  
 Personnel: Ken Edwards

Weather Conditions: 14 18 SW 20% Ø Ø  
 TEMP (°C) WIND speed/direction CLOUD PPT PPT (last 24-hrs)

% VEG. COVER	VEG. HEIGHT	VISIBILITY CLASS <sup>4</sup>
≥ 90% bare ground	≤ 15cm tall	Class 1 (Easy)
≥ 25% bare ground	≤ 15cm tall	Class 2 (Moderate)
≤ 25% bare ground	≤ 25% > 30cm tall	Class 3 (Difficult)
Little/no bare ground	≥ 25% > 30cm tall	Class 4 (Very difficult)

DECOMPOSITION CODES<sup>2</sup>:  
 Fresh Moderate Complete  
 Early Advanced Scavenged

Turbine No.	Area (m <sup>2</sup> )	Start Time	End Time	Duration	Species	Sex (m/f/u)	Bat Forearm <sup>1</sup> (mm)	UTM Coordinates		Decomposition Code <sup>2</sup>	Est. Hours Since Death	Injury <sup>3</sup> Sustained	Distance from Turbine (m)	Direction from Turbine	Substrate	Visibility Class <sup>4</sup>	Photo #
								Zone	Easting								
7	7854	8:40	9:15	35 min	—			E	N								
6	7854	9:25	9:55	30 min	—			E	N								
11	7854	10:05	10:35	30 min	—			E	N								
12	7854	10:55	11:35	40 min	—			E	N								
14	4712	12:05	12:45	40 min	golden crowned Kinglet	U	—	17T E044 7193	N 476 4890	fresh	<24	none visible	41	NE	grass/grand	2	1
17	7854	13:00	13:30	30 min	—			E	N								
<del>20</del>	<del>7854</del>	<del>13:50</del>	<del>14:35</del>	<del>45 min</del>	—			E	N								
22	5267	14:45	15:25	40 min	med. bird	U	—	17T E043 8309	N 476 3214	advanced	2-3 wks	none visible	7	NW	grass	2	1
					Red Tailed	/	/	17T E043 8325	N 476 3232	TEST CARCASS			35	NE	grass/grand	2	
27	7854	15:50	16:35	45 min	med. bird	/	/	17T E043 5955	N 476 5472	TEST CARCASS			7	W	grass	2	
19	—	maintenance															
								E	N								

155X155

<sup>1</sup> See bat forearm diagram on reverse of page.  
<sup>3</sup> INJURY TYPES: None Visible / Broken Limb / Broken Neck / Broken Wing / Cut in Half / Decapitated / Head Injury / Severed Wing / Wound to Abdomen

PAGE 1 OF 1

Print Name & Initial: Ken Edwards KE  
 (field notes author)

Quality Control: This form is complete  & legible

Print Name & Initial: Anna Corrigan  
 (field notes QA/QC personnel)

**Mortality Survey Observation Form**

\*Note - snow fell from Friday night has left ~5-20cm of snow in survey area which made it difficult to survey turbine.  
 Include Turbines: 27, 22, 20+19

Project No: 160961010 Project Name: Adelaide Wind Farm  
 Date: Oct 19, 2015 Personnel: A. Corrigan  
 Start/End Time: 8:40am / 3:15pm  
 Weather Conditions: 2-14 22-38 / SW 10-100% none Snow  
 TEMP (°C) km/h WIND CLOUD PPT PPT (last 24-hrs)  
 speed/direction

% VEG. COVER	VEG. HEIGHT	VISIBILITY CLASS <sup>4</sup>
≥ 90% bare ground	≤ 15cm tall	Class 1 (Easy)
≥ 25% bare ground	≤ 15cm tall	Class 2 (Moderate)
≤ 25% bare ground	≤ 25% > 30cm tall	Class 3 (Difficult)
Little/no bare ground	≥ 25% > 30cm tall	Class 4 (Very difficult)

DECOMPOSITION CODES<sup>2</sup>:  
 Fresh Moderate Complete  
 Early Advanced Scavenged

Turbine No.	Area (m <sup>2</sup> )	Start Time	End Time	Duration (mins)	Species	Sex (m/f/u)	Bat Forearm <sup>1</sup> (mm)	UTM Coordinates			Decomposition Code <sup>2</sup>	Est. Hours Since Death	Injury <sup>3</sup> Sustained	Distance from Turbine (m)	Direction from Turbine	Substrate	Visibility Class <sup>4</sup>	Photo #
								Zone	Easting	Northing								
27	7854	8:45a	9:21am	36	/	*	see note above	E	N									
22	5267	9:40am	10:11am	31	/	*	see note above	E	N									
20	7854	10:20a	10:56	36	/	*	see note above	E	N									
19	7854	11:08am	11:44a	36	/	*	see note above	E	N									
17	7854	11:52a	12:26p	34	/		- snow did not impact the survey area of this turbine or any other turbine for the remainder of the day	E	N									
14	4712	12:34p	1:04pm	30	/			E	N									
12	7854	1:11pm	1:43pm	32	/			E	N									
6	7854	1:52pm	2:23p	31	/			E	N									
7	7854	2:32p	3:03p	31	/			E	N									
11	* turbine maintenance is occurring and will be ongoing for the rest of the day - unable to safely survey																	

<sup>1</sup> See bat forearm diagram on reverse of page.

<sup>3</sup> INJURY TYPES: None Visible / Broken Limb / Broken Neck / Broken Wing / Cut in Half / Decapitated / Head Injury / Severed Wing / Wound to Abdomen

PAGE 1 OF 1

Print Name & Initial: Anna Corrigan

(field notes author)

Quality Control:

Print Name & Initial: Amanda Bichel

(field notes QA/QC personnel)

This form is complete  & legible



## Mortality Survey Observation Form

Project No: 160961010 Project Name: Adelaide Wind Farm

Date: Oct 22, 2015 Personnel: A. Corrigan

Start/End Time: 8:15am / 1:45pm

Weather Conditions: 13-14 19-23 / NW 10-90 Ø Ø  
TEMP (°C) WIND CLOUD PPT PPT (last 24-hrs)  
speed/direction

**DECOMPOSITION CODES<sup>2</sup>:**  
 Fresh Moderate Complete  
 Early Advanced Scavenged

% VEG. COVER	VEG. HEIGHT	VISIBILITY CLASS <sup>4</sup>
≥ 90% bare ground	≤ 15cm tall	Class 1 (Easy)
≥ 25% bare ground	≤ 15cm tall	Class 2 (Moderate)
≤ 25% bare ground	≤ 25% > 30cm tall	Class 3 (Difficult)
Little/no bare ground	≥ 25% > 30cm tall	Class 4 (Very difficult)

Turbine No.	Area (m <sup>2</sup> )	Start Time	End Time	Duration (mins)	Species	Sex (m/f/u)	Bat Forearm <sup>1</sup> (mm)	UTM Coordinates			Decomposition Code <sup>2</sup>	Est. Hours Since Death	Injury <sup>3</sup>	Distance from Turbine (m)	Direction from Turbine	Substrate	Visibility Class <sup>4</sup>	Photo #
								Zone	Easting	Northing								
27	7854	8:20a	8:51a	31	/			E	N									
22	5267	8:59a	9:29a	30	/			E	N									
20	* turbine under maintenance - unable to survey *																	
19	7854	9:41a	10:12a	31	/			E	N									
17	7854	10:19a	10:49a	30	/			E	N									
14	4712	10:56a	11:26a	30	/			E	N									
12	7854	11:37a	12:08p	31	/			E	N									
11	* turbine under maintenance - unable to survey *																	
7	7854	12:25p	12:57p	32	/			E	N									
6	7854	1:04p	1:35p	31	/			E	N									
								E	N									

<sup>1</sup> See bat forearm diagram on reverse of page.  
<sup>3</sup> INJURY TYPES: None Visible / Broken Limb / Broken Neck / Broken Wing / Cut in Half / Decapitated / Head Injury / Severed Wing / Wound to Abdomen

PAGE 1 OF 1  
 Print Name & Initial: Amanda Corrigan *AC*  
(field notes author)

Quality Control:  This form is complete & legible   
 Print Name & Initial: Amanda Bichel *AB*  
(field notes QA/QC personnel)



## Mortality Survey Observation Form

Project No: 160961010 Project Name: Ade Jasje Wind Farm  
 Date: Oct 26/2015 Personnel: Ken Edwards

Start/End Time: 8:35 / 14:35

Weather Conditions: 9 Shall E 30% Ø Ø  
 TEMP (°C) WIND CLOUD PPT PPT (last 24-hrs)  
 speed/direction

**DECOMPOSITION CODES<sup>2</sup>:**

Fresh Moderate Complete  
 Early Advanced Scavenged

% VEG. COVER	VEG. HEIGHT	VISIBILITY CLASS <sup>4</sup>
≥ 90% bare ground	≤ 15cm tall	Class 1 (Easy)
≥ 25% bare ground	≤ 15cm tall	Class 2 (Moderate)
≤ 25% bare ground	≤ 25% > 30cm tall	Class 3 (Difficult)
Little/no bare ground	≥ 25% > 30cm tall	Class 4 (Very difficult)

Turbine No.	Area (m <sup>2</sup> )	Start Time	End Time	Duration	Species	Sex (m/f/u)	Bat Forearm <sup>1</sup> (mm)	UTM Coordinates		Decomposition Code <sup>2</sup>	Est. Hours Since Death	Injury <sup>3</sup> Sustained	Distance from Turbine (m)	Direction from Turbine	Substrate	Visibility Class <sup>4</sup>	Photo #
								Zone	Easting								
7	7854	8:35	9:10	35min	—			E	N								
6	7854	9:20	9:50	30min	—			E	N								
12	7854	10:10	10:40	30min	—			E	N								
14	7854	10:30	11:20	30min	—			E	N								
17	7854	11:30	12:05	35min	—			E	N								
20	7854	12:35	13:05	30min	—			E	N								
22	7854	13:10	13:40	30min	—			E	N								
27	7854	13:50	14:25	35min	—			E	N								
11	- maintenance																
19	- maintenance																
								E	N								
								E	N								

<sup>1</sup> See bat forearm diagram on reverse of page.

<sup>3</sup> INJURY TYPES: None Visible / Broken Limb / Broken Neck / Broken Wing / Cut in Half / Decapitated / Head Injury / Severed Wing / Wound to Abdomen

PAGE 1 OF 1

Print Name & Initial: Ken Edwards KE  
 (field notes author)

Quality Control: This form is complete  & legible

Print Name & Initial: Anna Corrigan AC  
 (field notes QA/QC personnel)



## Mortality Survey Observation Form

 Project No: 160961010

 Project Name: Adelaide Wind Farm

 Date: Oct 29 / 2015

 Personnel: Ken Edwards

 Start/End Time: 8:40 / 15:10

 Weather Conditions: 5 35 km/h SW 70% yes  
 TEMP (°C) WIND speed/direction CLOUD PPT PPT (last 24-hrs)

 DECOMPOSITION CODES<sup>2</sup>:  
 Fresh Moderate Complete  
 Early Advanced Scavenged

% VEG. COVER	VEG. HEIGHT	VISIBILITY CLASS <sup>4</sup>
≥ 90% bare ground	≤ 15cm tall	Class 1 (Easy)
≥ 25% bare ground	≤ 15cm tall	Class 2 (Moderate)
≤ 25% bare ground	≤ 25% > 30cm tall	Class 3 (Difficult)
Little/no bare ground	≥ 25% > 30cm tall	Class 4 (Very difficult)

Turbine No.	Area (m <sup>2</sup> )	Start Time	End Time	Duration	Species	Sex (m/f/u)	Bat Forearm <sup>1</sup> (mm)	UTM Coordinates		Decomposition Code <sup>2</sup>	Est. Hours Since Death	Injury <sup>3</sup> Sustained	Distance from Turbine (m)	Direction from Turbine	Substrate	Visibility Class <sup>4</sup>	Photo #
								Zone	Easting								
7	7854	8:40	9:10	30min	—			E	N								
6	7854	9:20	9:55	35min	—			E	N								
12	7854	10:05	10:35	30min	—			E	N								
14	7854	10:45	11:15	30min	—			E	N								
17	7854	11:25	12:00	35min	—			E	N								
19	7854	12:25	12:55	30min	—			E	N								
20	7854	13:05	13:35	30min	—			E	N								
22	7854	13:45	14:15	30min	—			E	N								
27	7854	14:25	15:00	35min	—			E	N								
11	- turbine maintenance																
								E	N								
								E	N								

1 See bat forearm diagram on reverse of page.

3 INJURY TYPES: None Visible / Broken Limb / Broken Neck / Broken Wing / Cut in Half / Decapitated / Head Injury / Severed Wing / Wound to Abdomen

 PAGE 1 OF 1

 Print Name & Initial: Ken Edwards KE  
 (field notes author)

Quality Control:

 Print Name & Initial: Anna Corrigan AC  
 (field notes QA/QC personnel)

 This form is complete  & legible

**Mortality Survey  
Observation Form**

SAR TURBINES.

- No connection factors

Project No: 160961010

Project Name: Adelaide Wind Farm

Date: April 29, 2015

Personnel: Anna Corrigan + Melissa Straus + Ken Edwards

Start/End Time: 2:30pm / 1:45

Ken Edwards

Weather Conditions: 14°C / 19km/h / NNE  
TEMP (°C) WIND speed/direction

30% / 0 / 0  
CLOUD PPT PPT (last 24-hrs)

DECOMPOSITION CODES:  
Fresh Moderate Complete  
Early Advanced Scavenged

% VEG. COVER	VEG. HEIGHT	VISIBILITY CLASS <sup>4</sup>
≥ 90% bare ground	≤ 15cm tall	Class 1 (Easy)
≥ 25% bare ground	≤ 15cm tall	Class 2 (Moderate)
≤ 25% bare ground	≤ 25% > 30cm tall	Class 3 (Difficult)
Little/no bare ground	≥ 25% > 30cm tall	Class 4 (Very difficult)

Turbine No.	Area (m <sup>2</sup> )	Start Time	End Time	Duration	Species	Sex (m/f/u)	Bat Forearm <sup>1</sup> (mm)	UTM Coordinates		Decomposition Code <sup>2</sup>	Est. Hours Since Death	Injury <sup>3</sup> Sustained	Distance from Turbine (m)	Direction from Turbine	Substrate	Visibility Class <sup>4</sup>	Photo #
								Zone	Easting								
5	7854	14:52	15:30	38	-	3	searchers	E	N								
8	7854	16:00	16:20	20	-	3	searchers	E	N								
9	7854	16:25	16:41	16	-	3	searchers	E	N								
13	7854	16:54	17:10	16	-	3	searchers	E	N								
15	7854	17:17	17:34	17	-	4		E	N								
18	7854	17:44	17:58	14	-	4		E	N								
21	7854	18:04	18:18	14	-	3	searchers	E	N								
26	7854	18:25	18:56	11	-	3	searchers	E	N								
								E	N								
								E	N								
								E	N								
								E	N								

Head  
rest in 1 yong

<sup>1</sup> See bat forearm diagram on reverse of page.

<sup>3</sup> INJURY TYPES: None Visible / Broken Limb / Broken Neck / Broken Wing / Cut in Half / Decapitated / Head Injury / Severed Wing / Wound to Abdomen

**Mortality Survey  
Observation Form**

SAR

Project No: 160961016 Project Name: Adelaide Wind Farm  
 Date: May 26/2015 Personnel: Ken Edwards  
 Start/End Time: 8:30 / 16:00  
 Weather Conditions: 18-26 15kph/SSW 30% no no  
 TEMP (°C) WIND CLOUD PPT PPT (last 24-hrs)  
 speed/direction

DECOMPOSITION CODES<sup>2</sup>:  
 Fresh Moderate Complete  
 Early Advanced Scavenged

% VEG. COVER	VEG. HEIGHT	VISIBILITY CLASS <sup>4</sup>
≥ 90% bare ground	≤ 15cm tall	Class 1 (Easy)
≥ 25% bare ground	≤ 15cm tall	Class 2 (Moderate)
≤ 25% bare ground	≤ 25% > 30cm tall	Class 3 (Difficult)
Little/no bare ground	≥ 25% > 30cm tall	Class 4 (Very difficult)

Turbine No.	Area (m <sup>2</sup> )	Start Time	End Time	Duration	Species	Sex (m/f/u)	Bat Forearm <sup>1</sup> (mm)	UTM Coordinates		Decomposition Code <sup>2</sup>	Est. Hours Since Death	Injury <sup>3</sup> Sustained	Distance from Turbine (m)	Direction from Turbine	Substrate	Visibility Class <sup>4</sup>	Photo #
								Zone	Easting								
5	7854	8:40	9:35	55min	—			E	N								
8	"	9:45	10:25	40min	—			E	N								
9	"	10:35	11:20	45min	—			E	N								
13	"	11:30	12:20	50min	—			E	N								
15	"	12:40	13:35	55min	—			E	N								
21	"	13:50	15:00	1h 10	—			E	N								
26	"	15:10	15:50	40min	—			E	N								
18	"	maintenance						E	N								
								E	N								
								E	N								
								E	N								
								E	N								

<sup>1</sup> See bat forearm diagram on reverse of page.

<sup>3</sup> INJURY TYPES: None Visible / Broken Limb / Broken Neck / Broken Wing / Cut in Half / Decapitated / Head Injury / Severed Wing / Wound to Abdomen



## Mortality Survey Observation Form

Project No: 160961010  
 Date: May 27, 2015  
 Start/End Time: 8:05 / 9:35

Project Name: Adelgade Wind Farm  
 Personnel: Ken Edwards

Weather Conditions: 15 TEMP (°C)    6km/h / SE WIND speed/direction    0% CLOUD    no PPT    yes PPT (last 24-hrs)

DECOMPOSITION CODES<sup>2</sup>:  
 Fresh      Moderate      Complete  
 Early      Advanced      Scavenged

% VEG. COVER	VEG. HEIGHT	VISIBILITY CLASS <sup>4</sup>
≥ 90% bare ground	≤ 15cm tall	Class 1 (Easy)
≥ 25% bare ground	≤ 15cm tall	Class 2 (Moderate)
≤ 25% bare ground	≤ 25% > 30cm tall	Class 3 (Difficult)
Little/no bare ground	≥ 25% > 30cm tall	Class 4 (Very difficult)

Turbine No.	Area (m <sup>2</sup> )	Start Time	End Time	Duration	Species	Sex (m/f/u)	Bat Forearm <sup>1</sup> (mm)	UTM Coordinates		Decomposition Code <sup>2</sup>	Est. Hours Since Death	Injury <sup>3</sup> Sustained	Distance from Turbine (m)	Direction from Turbine	Substrate	Visibility Class <sup>4</sup>	Photo #
								Zone	Easting								
18	7854	8:05	8:35	30min	—			E	N								
								E	N								
								E	N								
								E	N								
								E	N								
								E	N								
								E	N								
								E	N								
								E	N								
								E	N								
								E	N								
								E	N								
								E	N								
								E	N								
								E	N								

<sup>1</sup> See bat forearm diagram on reverse of page.  
<sup>3</sup> INJURY TYPES: None Visible / Broken Limb / Broken Neck / Broken Wing / Cut in Half / Decapitated / Head Injury / Severed Wing / Wound to Abdomen

PAGE 2 OF 2  
 Print Name & Initial: Ken Edwards (field notes author)      Quality Control: Amanda Bichel (field notes QA/QC personnel)  
 This form is complete  & legible



**Mortality Survey  
Observation Form**

SAR

Project No: 160961010 Project Name: Adelaide Wind Farm  
 Date: June 19 Personnel: Ken Edwards  
 Start/End Time: 10:30 11:40

Weather Conditions: 22°C 6km/h 1 NW 30% no light  
 TEMP (°C) WIND CLOUD PPT PPT (last 24-hrs)  
 speed/direction

DECOMPOSITION CODES:  
 Fresh Moderate Complete  
 Early Advanced Scavenged

% VEG. COVER	VEG. HEIGHT	VISIBILITY CLASS <sup>4</sup>
≥ 90% bare ground	≤ 15cm tall	Class 1 (Easy)
≥ 25% bare ground	≤ 15cm tall	Class 2 (Moderate)
≤ 25% bare ground	≤ 25% > 30cm tall	Class 3 (Difficult)
Little/no bare ground	≥ 25% > 30cm tall	Class 4 (Very difficult)

Turbine No.	Area (m <sup>2</sup> )	Start Time	End Time	Duration	Species	Sex (m/f/u)	Bat Forearm <sup>1</sup> (mm)	UTM Coordinates		Decomposition Code <sup>2</sup>	Est. Hours Since Death	Injury <sup>3</sup> Sustained	Distance from Turbine (m)	Direction from Turbine	Substrate	Visibility Class <sup>4</sup>	Photo #
								Zone	Easting								
8	854	10:40	11:40	1hr	-			E	N								
15	"	11:50	12:55	1hr 5	cuckoo	u	-	17T	E 044 6076	N 476 5059	fresh	24h	nv	51	NW	Field	2
26	11	13:20	13:50	30min	-			E	N								
21	11	14:00	15:35	1h35	-			E	N								
35	"	15:45	16:35	50min	-			E	N								
								E	N								
								E	N								
								E	N								
								E	N								
								E	N								
								E	N								

<sup>1</sup> See bat forearm diagram on reverse of page.  
<sup>3</sup> INJURY TYPES: None Visible / Broken Limb / Broken Neck / Broken Wing / Cut in Half / Decapitated / Head Injury / Severed Wing / Wound to Abdomen

PAGE 1 OF 2  
 Print Name & Initial: Ken Edwards  
 (field notes author)

Quality Control: \_\_\_\_\_ This form is complete  & legible   
 Print Name & Initial: Amanda Bichel  
 (field notes QA/QC personnel)

### Mortality Survey Observation Form

Project No: 160961010 Project Name: Adelaide Wind Farm  
 Date: June 21/2015 Personnel: Ken Edwards  
 Start/End Time: 12:30 / 16:30

Weather Conditions: 22 18km/h NW 20% no no  
 TEMP (°C) WIND speed/direction CLOUD PPT PPT (last 24-hrs)

DECOMPOSITION CODES<sup>2</sup>:  
 Fresh Moderate Complete  
 Early Advanced Scavenged

% VEG. COVER	VEG. HEIGHT	VISIBILITY CLASS <sup>4</sup>
≥ 90% bare ground	≤ 15cm tall	Class 1 (Easy)
≥ 25% bare ground	≤ 15cm tall	Class 2 (Moderate)
≤ 25% bare ground	≤ 25% > 30cm tall	Class 3 (Difficult)
Little/no bare ground	≥ 25% > 30cm tall	Class 4 (Very difficult)

Turbine No.	Area (m <sup>2</sup> )	Start Time	End Time	Duration	Species	Sex (m/f/u)	Bat Forearm <sup>1</sup> (mm)	UTM Coordinates		Decomposition Code <sup>2</sup>	Est. Hours Since Death	Injury <sup>3</sup> Sustained	Distance from Turbine (m)	Direction from Turbine	Substrate	Visibility Class <sup>4</sup>	Photo #	
								Zone	Easting									Northing
9	7854	12:45	14:15	1h30	raptor sprey	U	-	17T	E044 9748	N476 3043	Moderate Abdomen	2 weeks	none visible	50	S	field	2	5
13	"	14:20	15:00	40min	-				E	N								
18	"	15:10	16:20	1h10	-				E	N								
									E	N								
									E	N								
									E	N								
									E	N								
									E	N								
									E	N								
									E	N								

<sup>1</sup> See bat forearm diagram on reverse of page.

<sup>3</sup> INJURY TYPES: None Visible / Broken Limb / Broken Neck / Broken Wing / Cut in Half / Decapitated / Head Injury / Severed Wing / Wound to Abdomen

Print Name & Initial: Ken Edwards KE  
 (field notes author)

Quality Control:

This form is complete  & legible   
 Print Name & Initial: Amanda Bachel AB  
 (field notes QA/QC personnel)

Mortality Survey Observation Form

Project No: 160961010 Project Name: Alewife Wind Farm  
 Date: July 21/2015 Personnel: Ken Edwards  
 Start/End Time: 8:30 / 18:05  
 Weather Conditions: 20-23 18km/h / NW 10% Ø Ø  
 TEMP (°C) WIND speed/direction CLOUD PPT PPT (last 24-hrs)

% VEG. COVER	VEG. HEIGHT	VISIBILITY CLASS <sup>4</sup>
≥ 90% bare ground	≤ 15cm tall	Class 1 (Easy)
≥ 25% bare ground	≤ 15cm tall	Class 2 (Moderate)
≤ 25% bare ground	≤ 25% > 30cm tall	Class 3 (Difficult)
Little/no bare ground	≥ 25% > 30cm tall	Class 4 (Very difficult)

DECOMPOSITION CODES<sup>2</sup>:  
 Fresh Moderate Complete  
 Early Advanced Scavenged

Turbine No.	Area (m <sup>2</sup> )	Start Time	End Time	Duration	Species	Sex (m/f/u)	Bat Forearm <sup>1</sup> (mm)	UTM Coordinates		Decomposition Code <sup>2</sup>	Est. Hours Since Death	Injury <sup>3</sup> Sustained	Distance from Turbine (m)	Direction from Turbine	Substrate	Visibility Class <sup>4</sup>	Photo #
								Zone	Easting								
8	-	8:30	10:00	1h30	-			E	N								
9	-	10:05	11:25	1h20	-			E	N								
13	-	11:35	13:00	1h25	-			E	N								
15	-	13:10	14:20	1h10	-			E	N								
18	-	14:30	15:40	1h10	-			E	N								
5	-	15:55	16:55	1h	-			E	N								
								E	N								
								E	N								
								E	N								
								E	N								
								E	N								

<sup>1</sup> See bat forearm diagram on reverse of page.

<sup>3</sup> INJURY TYPES: None Visible / Broken Limb / Broken Neck / Broken Wing / Cut in Half / Decapitated / Head Injury / Severed Wing / Wound to Abdomen

PAGE 1 OF 2  
 Print Name & Initial: Ken Edwards KE  
 (field notes author)

Quality Control: This form is complete  & legible   
 Print Name & Initial: Amanda Bichel AB  
 (field notes QA/QC personnel)

Mortality Survey  
Observation Form

Project No: 160961010  
Date: July 22/2015  
Start/End Time: 8:50 / 12:00

Project Name: Adelaide Wind Farm  
Personnel: Ken Edwards

Weather Conditions: 23 TEMP (°C) 2.1 km/h / SW WIND speed/direction ∅ CLOUD ∅ PPT ∅ PPT (last 24-hrs)

DECOMPOSITION CODES<sup>2</sup>:  
Fresh Moderate Complete  
Early Advanced Scavenged

% VEG. COVER	VEG. HEIGHT	VISIBILITY CLASS <sup>4</sup>
≥ 90% bare ground	≤ 15cm tall	Class 1 (Easy)
≥ 25% bare ground	≤ 15cm tall	Class 2 (Moderate)
≤ 25% bare ground	≤ 25% > 30cm tall	Class 3 (Difficult)
Little/no bare ground	≥ 25% > 30cm tall	Class 4 (Very difficult)

Turbine No.	Area (m <sup>2</sup> )	Start Time	End Time	Duration	Species	Sex (m/f/u)	Bat Forearm <sup>1</sup> (mm)	UTM Coordinates		Decomposition Code <sup>2</sup>	Est. Hours Since Death	Injury <sup>3</sup> Sustained	Distance from Turbine (m)	Direction from Turbine	Substrate	Visibility Class <sup>4</sup>	Photo #
								Zone	Easting								
21	-	9:00	10:45	1:45	-			E	N								
26	-	10:53	12:00	1:15	-			E	N								
								E	N								
								E	N								
								E	N								
								E	N								
								E	N								
								E	N								
								E	N								
								E	N								
								E	N								
								E	N								
								E	N								
								E	N								
								E	N								

<sup>1</sup> See bat forearm diagram on reverse of page.  
<sup>3</sup> INJURY TYPES: None Visible / Broken Limb / Broken Neck / Broken Wing / Cut in Half / Decapitated / Head Injury / Severed Wing / Wound to Abdomen

PAGE 2 OF 2  
Print Name & Initial: Ken Edwards KE  
(field notes author)

Quality Control: \_\_\_\_\_ This form is complete  & legible   
Print Name & Initial: Amanda Bichel AB  
(field notes QA/QC personnel)

**Mortality Survey  
Observation Form**

SAR

Project No: 160961010  
Date: Aug 26, 2015  
Start/End Time: 8:40 / 18:15

Project Name: Adelaide Wind Farm  
Personnel: Ken Edwards

Weather Conditions: 14 14km/h W 100 0 0  
TEMP (°C) WIND CLOUD PPT PPT (last 24-hrs)  
speed/direction

DECOMPOSITION CODES<sup>2</sup>:  
Fresh Moderate Complete  
Early Advanced Scavenged

% VEG. COVER	VEG. HEIGHT	VISIBILITY CLASS <sup>4</sup>
≥ 90% bare ground	≤ 15cm tall	Class 1 (Easy)
≥ 25% bare ground	≤ 15cm tall	Class 2 (Moderate)
≤ 25% bare ground	≤ 25% > 30cm tall	Class 3 (Difficult)
Little/no bare ground	≥ 25% > 30cm tall	Class 4 (Very difficult)

Turbine No.	Area (m <sup>2</sup> )	Start Time	End Time	Duration	Species	Sex (m/f/u)	Bat Forearm <sup>1</sup> (mm)	UTM Coordinates		Decomposition Code <sup>2</sup>	Est. Hours Since Death	Injury <sup>3</sup> Sustained	Distance from Turbine (m)	Direction from Turbine	Substrate	Visibility Class <sup>4</sup>	Photo #	
								Zone	Easting									Northing
5	7854	8:40	9:45	1h 5min	silver haired	U	41.38	17T	E 045 1177	N 476 2371	advanced	2-3 wks	none visible	24	nw	ground	1	2
8	"	9:55	10:55	1hr	—				E	N								
9	"	11:05	12:05	1hr	—				E	N								
13	"	12:25	13:05	40min	—				E	N								
15	"	13:15	14:45	1h 30	—				E	N								
18	"	14:55	15:55	1h	—				E	N								
21	"	16:00	17:40	1h 40	med. bird	U		17T	E 043 9187	N 476 3527	complete	month	nu	25	W	grass	2	1
"	"	"	"	"	hoary bat	U	57.08	17T	E 043 9173	N 476 3559	Fresh	24hrs	Broken wing	21	NE	ground	1	1
"	"	"	"	"	little brown	U	38.12	17T	E 043 9155	N 476 3541	moderate	1-2 wks	none visible	5	NW	ground	1	2
26	"	17:45	18:25	40min	—				E	N								

<sup>1</sup> See bat forearm diagram on reverse of page.

<sup>3</sup> INJURY TYPES: None Visible / Broken Limb / Broken Neck / Broken Wing / Cut in Half / Decapitated / Head Injury / Severed Wing / Wound to Abdomen

PAGE 1 OF 1  
Print Name & Initial: Ken Edwards KE  
(field notes author)

Quality Control: \_\_\_\_\_ This form is complete  & legible   
Print Name & Initial: Amanda Bichel AB  
(field notes QA/QC personnel)

Mortality Survey  
Observation Form

→ SAR Turbine Surveys

Project No: ~~160960746~~ 160961067  
 Date: September 21, 2015  
 Start/End Time: 8:00am / 2:00pm

Project Name: Adairdale Wind Farm  
 Personnel: A. Corrigan

Weather Conditions: 10-21°C / 12-18 / E / 15% /  /   
 TEMP (°C) km/h WIND CLOUD PPT PPT (last 24-hrs)

DECOMPOSITION CODES:  
 Fresh Moderate Complete  
 Early Advanced Scavenged

% VEG. COVER	VEG. HEIGHT	VISIBILITY CLASS <sup>4</sup>
≥ 90% bare ground	≤ 15cm tall	Class 1 (Easy)
≥ 25% bare ground	≤ 15cm tall	Class 2 (Moderate)
≤ 25% bare ground	≤ 25% > 30cm tall	Class 3 (Difficult)
Little/no bare ground	≥ 25% > 30cm tall	Class 4 (Very difficult)

Turbine No.	Area (m <sup>2</sup> )	Start Time	End Time	Duration (mins)	Species	Sex (m/f/u)	Bat Forearm <sup>1</sup> (mm)	UTM Coordinates			Decomposition Code <sup>2</sup>	Est. Hours Since Death	Injury <sup>3</sup> Sustained	Distance from Turbine (m)	Direction from Turbine	Substrate	Visibility Class <sup>4</sup>	Photo #
								Zone	Easting	Northing								
26	7854	7:54a	8:25a	31	/			E		N								
18	7854	8:43a	9:15a	32	/			E		N								
15	7854	9:34a	10:15a	41	Silver-haired Bat	U	40.20	17	E 644 5946	N 4764 984	Advanced	168	None visible	13	E	gravel	1	1876-1879
13	7854	10:42a	11:21	39	/			E		N								
5	7854	11:35a	12:12p	37	/			E		N	* White-tailed deer observed in survey area *							
8	7854	12:29p	1:07pm	38	/			E		N								
9	7854	1:19p	2:02p	43	/			E		N	* 2 TUUV seen flying near turbine *							
21	* under maintenance during the course of the day - unable to safely survey *																	
								E		N								
								E		N								
								E		N								
								E		N								

<sup>1</sup> See bat forearm diagram on reverse of page.

<sup>3</sup> INJURY TYPES: None Visible / Broken Limb / Broken Neck / Broken Wing / Cut in Half / Decapitated / Head Injury / Severed Wing / Wound to Abdomen

PAGE 1 OF 1

Print Name & Initial: Anna Corrigan AC  
 (field notes author)

Quality Control:

Print Name & Initial: Amanda Bichel AB  
 (field notes QA/QC personnel)

This form is complete & legible

**Mortality Survey  
Observation Form**

SAR Turbine Surveys

Project No: ~~160950591~~ 160961067 Project Name: Atlanta Wind Farm  
 Date: Oct 15, 2015 Personnel: A. Corrigan  
 Start/End Time: 8:30am / 4:00pm  
 Weather Conditions: 9-17C 12-38 / SW 30-70% Drizzle Drizzle  
 TEMP (°C) km/h WIND CLOUD PPT PPT (last 24-hrs)  
 speed/direction

**DECOMPOSITION CODES<sup>2</sup>:**

Fresh Moderate Complete  
 Early Advanced Scavenged

% VEG. COVER	VEG. HEIGHT	VISIBILITY CLASS <sup>4</sup>
≥ 90% bare ground	≤ 15cm tall	Class 1 (Easy)
≥ 25% bare ground	≤ 15cm tall	Class 2 (Moderate)
≤ 25% bare ground	≤ 25% > 30cm tall	Class 3 (Difficult)
Little/no bare ground	≥ 25% > 30cm tall	Class 4 (Very difficult)

Turbine No.	Area (m <sup>2</sup> )	Start Time	End Time	Duration (mins)	Species	Sex (m/f/u)	Bat Forearm <sup>1</sup> (mm)	UTM Coordinates			Decomposition Code <sup>2</sup>	Est. Hours Since Death	Injury <sup>3</sup> Sustained	Distance from Turbine (m)	Direction from Turbine	Substrate	Visibility Class <sup>4</sup>	Photo #
								Zone	Easting	Northing								
26	7854	8:36a	9:10a	34	/			E	N									
15	7854	9:26a	9:54a	33	/			E	N									
18	7854	10:11a	10:45a	34	/			E	N									
13	7854	10:58a	11:11am	13				E	N									
9	7854	11:21a	11:57a	36	/			E	N									
5	7854	12:23p	12:55p	32	/			E	N									
8	7854	1:04p	1:37p	33	/			E	N									
13	7854	1:48p	2:08pm	20 / 33min total	/			E	N									
21	7854	3:20p	3:52p	32	/			E	N									
								E	N									
								E	N									
								E	N									

<sup>1</sup> See bat forearm diagram on reverse of page.

<sup>3</sup> INJURY TYPES: None Visible / Broken Limb / Broken Neck / Broken Wing / Cut in Half / Decapitated / Head Injury / Severed Wing / Wound to Abdomen

PAGE 1 OF 1

Print Name & Initial: Anna Corrigan *AC*

(field notes author)

Quality Control:

This form is complete  & legible

Print Name & Initial: Amanda Richal *AR*

(field notes QA/QC personnel)



## Mortality Survey Observation Form

Project No: ~~160961010~~ 160961010 Project Name: Adelaide Wind Farm

Date: Nov 5/2015 Personnel: Ken Edwards

Start/End Time: 8:40 / 11:50

Weather Conditions: 14 10km/h / S 30% Ø Ø  
 TEMP (°C) WIND speed/direction CLOUD PPT PPT (last 24-hrs)

DECOMPOSITION CODES<sup>2</sup>:  
 Fresh Moderate Complete  
 Early Advanced Scavenged

% VEG. COVER	VEG. HEIGHT	VISIBILITY CLASS <sup>4</sup>
≥ 90% bare ground	≤ 15cm tall	Class 1 (Easy)
≥ 25% bare ground	≤ 15cm tall	Class 2 (Moderate)
≤ 25% bare ground	≤ 25% > 30cm tall	Class 3 (Difficult)
Little/no bare ground	≥ 25% > 30cm tall	Class 4 (Very difficult)

Turbine No.	Area (m <sup>2</sup> )	Start Time	End Time	Duration	Species	Sex (m/f/u)	Bat Forearm <sup>1</sup> (mm)	UTM Coordinates			Decomposition Code <sup>2</sup>	Est. Hours Since Death	Injury <sup>3</sup> Sustained	Distance from Turbine (m)	Direction from Turbine	Substrate	Visibility Class <sup>4</sup>	Photo #
								Zone	Easting	Northing								
7	7854	8:40	9:10	30min	—			E	N									
6	7854	9:15	9:50	35min	—			E	N									
11	7854	10:05	10:35	30min	—			E	N									
14	7854	10:45	11:20	35min	—			E	N									
17	7854	11:30	12:00	30min	—			E	N									
19	7854	12:10	12:40	30min	—			E	N									
20	7854	12:50	13:20	30min	—			E	N									
22	7854	13:30	14:10	40min	—			E	N									
27	7854	14:20	15:00	40min	—			E	N									
								E	N									
								E	N									
								E	N									

<sup>1</sup> See bat forearm diagram on reverse of page.  
<sup>3</sup> INJURY TYPES: None Visible / Broken Limb / Broken Neck / Broken Wing / Cut in Half / Decapitated / Head Injury / Severed Wing / Wound to Abdomen

PAGE 1 OF 1  
 Print Name & Initial: Ken Edwards  
 (field notes author)

Quality Control: Anna Carrigan This form is complete  & legible   
 Print Name & Initial: Anna Carrigan  
 (field notes QA/QC personnel)





## Mortality Survey Observation Form

 Project No: 160961010

 Project Name: Adelaide Wind Farm

 Date: Nov 12/2015

 Personnel: Ken Edwards

 Start/End Time: 8:35 / 15:20

 Weather Conditions: 9 26km/h SE 100% ~~☒~~ yes  
 TEMP (°C)      WIND      CLOUD      PPT      PPT (last 24-hrs)  
speed/direction

% VEG. COVER	VEG. HEIGHT	VISIBILITY CLASS <sup>4</sup>
≥ 90% bare ground	≤ 15cm tall	Class 1 (Easy)
≥ 25% bare ground	≤ 15cm tall	Class 2 (Moderate)
≤ 25% bare ground	≤ 25% > 30cm tall	Class 3 (Difficult)
Little/no bare ground	≥ 25% > 30cm tall	Class 4 (Very difficult)

 DECOMPOSITION CODES<sup>2</sup>:  
 Fresh      Moderate      Complete  
 Early      Advanced      Scavenged

Turbine No.	Area (m <sup>2</sup> )	Start Time	End Time	Duration	Species	Sex (m/f/u)	Bat Forearm <sup>1</sup> (mm)	UTM Coordinates			Decomposition Code <sup>2</sup>	Est. Hours Since Death	Injury <sup>3</sup> Sustained	Distance from Turbine (m)	Direction from Turbine	Substrate	Visibility Class <sup>4</sup>	Photo #
								Zone	Easting	Northing								
7	7854	8:35	9:05	30min	—			E	N									
6	"	9:10	9:40	30min	—			E	N									
12	"	9:50	10:15	35min	—			E	N									
14	"	10:25	11:05	40min	—			E	N									
17	"	11:15	11:45	30min	—			E	N									
20	"	11:55	12:25	30min	—			E	N									
22	"	12:35	13:15	40min	—			E	N									
27	"	13:20	13:50	30min	—			E	N									
19	"	14:05	14:40	35min	—			E	N									
11	"	14:50	15:20	30min	—			E	N									
								E	N									
								E	N									

1 See bat forearm diagram on reverse of page.

3 INJURY TYPES: None Visible / Broken Limb / Broken Neck / Broken Wing / Cut in Half / Decapitated / Head Injury / Severed Wing / Wound to Abdomen

 PAGE 1 OF 1

 Print Name & Initial: Ken Edwards   
 (field notes author)

Quality Control:

 Print Name & Initial: Anna Corrigan   
 (field notes QA/QC personnel)

 This form is complete  & legible



## Mortality Survey Observation Form

Project No: 160961010 Project Name: Adelaide Wind Farm

Date: Nov 19/2015 Personnel: Ken Edwards

Start/End Time: 8:40 15:30

Weather Conditions: 13 26 / SW 30% Ø yes  
 TEMP (°C) WIND CLOUD PPT PPT (last 24-hrs)  
 speed/direction

DECOMPOSITION CODES<sup>2</sup>:  
 Fresh Moderate Complete  
 Early Advanced Scavenged

% VEG. COVER	VEG. HEIGHT	VISIBILITY CLASS <sup>4</sup>
≥ 90% bare ground	≤ 15cm tall	Class 1 (Easy)
≥ 25% bare ground	≤ 15cm tall	Class 2 (Moderate)
≤ 25% bare ground	≤ 25% > 30cm tall	Class 3 (Difficult)
Little/no bare ground	≥ 25% > 30cm tall	Class 4 (Very difficult)

Turbine No.	Area (m <sup>2</sup> )	Start Time	End Time	Duration	Species	Sex (m/f/u)	Bat Forearm <sup>1</sup> (mm)	UTM Coordinates		Decomposition Code <sup>2</sup>	Est. Hours Since Death	Injury <sup>3</sup> Sustained	Distance from Turbine (m)	Direction from Turbine	Substrate	Visibility Class <sup>4</sup>	Photo #
								Zone	Easting								
6	7854	8:40	9:15	35min	—			E	N								
11	"	9:30	10:00	30min	—			E	N								
12	"	10:05	10:40	35min	—			E	N								
14	"	10:45	11:20	35min	—			E	N								
17	"	11:30	12:00	30min	—			E	N								
20	"	12:05	13:10	35min	—			E	N								
22	"	13:20	13:50	30min	—			E	N								
27	"	14:00	14:40	40min	—			E	N								
7	"	14:50	15:20	30min	—			E	N								
19	—	construction/maintenance															
								E	N								
								E	N								

<sup>1</sup> See bat forearm diagram on reverse of page.

<sup>3</sup> INJURY TYPES: None Visible / Broken Limb / Broken Neck / Broken Wing / Cut in Half / Decapitated / Head Injury / Severed Wing / Wound to Abdomen

PAGE 1 OF 1

Print Name & Initial: Ken Edwards  
 (field notes author)

Quality Control: Anna Corrigan This form is complete  & legible

Print Name & Initial: Anna Corrigan  
 (field notes QA/QC personnel)



## Mortality Survey Observation Form

 Project No: 160961010

 Project Name: Adelaide Wind Farm

 Date: Nov 20 / 2015

 Personnel: Ken Edwards

 Start/End Time: 9:45 / 15:00

 Weather Conditions: 4 23 / W 20% Ø Ø  
 TEMP (°C) WIND speed/direction CLOUD PPT PPT (last 24-hrs)

**DECOMPOSITION CODES<sup>2</sup>:**

 Fresh Moderate Complete  
 Early Advanced Scavenged

% VEG. COVER	VEG. HEIGHT	VISIBILITY CLASS <sup>4</sup>
≥ 90% bare ground	≤ 15cm tall	Class 1 (Easy)
≥ 25% bare ground	≤ 15cm tall	Class 2 (Moderate)
≤ 25% bare ground	≤ 25% > 30cm tall	Class 3 (Difficult)
Little/no bare ground	≥ 25% > 30cm tall	Class 4 (Very difficult)

Turbine No.	Area (m <sup>2</sup> )	Start Time	End Time	Duration	Species	Sex (m/f/u)	Bat Forearm <sup>1</sup> (mm)	UTM Coordinates		Decomposition Code <sup>2</sup>	Est. Hours Since Death	Injury <sup>3</sup> Sustained	Distance from Turbine (m)	Direction from Turbine	Substrate	Visibility Class <sup>4</sup>	Photo #
								Zone	Easting								
5	SAR	9:45	9:20	35min	—			E	N								
8	SAR	9:30	10:10	40min	—			E	N								
9	SAR	10:20	11:00	40min	—			E	N								
13	SAR	11:15	11:50	35min	—			E	N								
15	SAR	12:05	12:40	35min	—			E	N								
18	SAR	12:50	13:25	35min	—			E	N								
21	SAR	13:35	14:15	40min	—			E	N								
26	SAR	14:25	15:00	35min	—			E	N								
								E	N								
								E	N								
								E	N								
								E	N								

1 See bat forearm diagram on reverse of page.

3 INJURY TYPES: None Visible / Broken Limb / Broken Neck / Broken Wing / Cut in Half / Decapitated / Head Injury / Severed Wing / Wound to Abdomen

PAGE \_\_\_ OF \_\_\_

 Print Name & Initial: Ken Edwards   
 (field notes author)

Quality Control:

 Print Name & Initial: \_\_\_\_\_ This form is complete  & legible 

(field notes QA/QC personnel)

### Mortality Survey Observation Form

Project No: 160961010 Project Name: Adelaide Wind Farm

Date: Nov 26/2015 Personnel: Ken Edwards

Start/End Time: 9:00 / 15:53

Weather Conditions: 10 24 15 100% light 0  
 TEMP (°C) WIND CLOUD PPT PPT (last 24-hrs)  
 speed/direction

DECOMPOSITION CODES:  
 Fresh Moderate Complete  
 Early Advanced Scavenged

% VEG. COVER	VEG. HEIGHT	VISIBILITY CLASS <sup>4</sup>
≥ 90% bare ground	≤ 15cm tall	Class 1 (Easy)
≥ 25% bare ground	≤ 15cm tall	Class 2 (Moderate)
≤ 25% bare ground	≤ 25% > 30cm tall	Class 3 (Difficult)
Little/no bare ground	≥ 25% > 30cm tall	Class 4 (Very difficult)

Turbine No.	Area (m <sup>2</sup> )	Start Time	End Time	Duration	Species	Sex (m/f/u)	Bat Forearm <sup>1</sup> (mm)	UTM Coordinates			Decomposition Code <sup>2</sup>	Est. Hours Since Death	Injury <sup>3</sup> Sustained	Distance from Turbine (m)	Direction from Turbine	Substrate	Visibility Class <sup>4</sup>	Photo #
								Zone	Easting	Northing								
7	7854	9:00	9:31	31min	—			E	N									
6	"	9:38	10:12	34min	—			E	N									
11	"	10:19	10:51	32min	—			E	N									
12	"	11:00	11:42	42min	—			E	N									
14	"	12:15	12:55	40min	—			E	N									
17	"	13:07	13:37	30min	—			E	N									
20	"	13:47	14:25	38min	—			E	N									
22	"	14:44	15:11	30min	—			E	N									
27	"	15:20	15:53	33min	—			E	N									
19	maintenance																	
								E	N									

<sup>1</sup> See bat forearm diagram on reverse of page.

<sup>3</sup> INJURY TYPES: None Visible / Broken Limb / Broken Neck / Broken Wing / Cut in Half / Decapitated / Head Injury / Severed Wing / Wound to Abdomen

PAGE 1 OF 1

Print Name & Initial: Ken Edwards KE  
 (field notes author)

Quality Control: This form is complete  & legible

Print Name & Initial: Anna Conigan AC  
 (field notes QA/QC personnel)

### Mortality Survey Observation Form

Project No: 160961010  
 Date: June 5/2015  
 Start/End Time: 12:05 / n/a

Project Name: Adelashie Wind Farm  
 Personnel: Ken Edwards

Weather Conditions: 20 TEMP (°C) 11 km/h / W WIND 100% CLOUD no PPT no PPT (last 24-hrs)

*not regular search*

DECOMPOSITION CODES:  
 Fresh Moderate Complete  
 Early Advanced Scavenged

% VEG. COVER	VEG. HEIGHT	VISIBILITY CLASS <sup>4</sup>
≥ 90% bare ground	≤ 15cm tall	Class 1 (Easy)
≥ 25% bare ground	≤ 15cm tall	Class 2 (Moderate)
≤ 25% bare ground	≤ 25% > 30cm tall	Class 3 (Difficult)
Little/no bare ground	≥ 25% > 30cm tall	Class 4 (Very difficult)

Turbine No.	Area (m <sup>2</sup> )	Start Time	End Time	Duration	Species	Sex (m/f/u)	Bat Forearm <sup>1</sup> (mm)	UTM Coordinates		Decomposition Code <sup>2</sup>	Est. Hours Since Death	Injury <sup>3</sup> Sustained	Distance from Turbine (m)	Direction from Turbine	Substrate	Visibility Class <sup>4</sup>	Photo #
								Zone	Easting Northing								
18	7854	12:05	n/a	n/a	Big brown bat	U	44.5	17T	E 044 3804 N 476 5067	-	live	severed wing	3	N	gravel	1	2
* Incidental Discovery from Maintenance crew								E	N								
								E	N								
								E	N								
								E	N								
								E	N								
								E	N								
								E	N								
								E	N								
								E	N								

1 See bat forearm diagram on reverse of page.  
 3 INJURY TYPES: None Visible / Broken Limb / Broken Neck / Broken Wing / Cut in Half / Decapitated / Head Injury / Severed Wing / Wound to Abdomen

PAGE 1 OF 1  
 Print Name & Initial: Ken Edwards KE  
 (field notes author)

Quality Control: \_\_\_\_\_ This form is complete  & legible   
 Print Name & Initial: Anna Coxman  
 (field notes QA/QC personnel)

*APPENDIX G2:  
FIELD FORMS  
(DISTURBANCE MONITORING)*



**Stantec Consulting Ltd.**  
 1 - 70 Southgate Drive  
 Guelph, ON  
 Canada N1G 4P5  
 Tel: (519) 836-6050  
 Fax: (519) 836-2493

## Amphibian Call Survey Observation Form

Project Number: 160961010

Project Name: Adelaide

Date: 29-APR-2015

Field Personnel: M. Straus + A. Corrigan

Weather Conditions:	TEMP (°C):	WIND:	CLOUD:	PPT:	PPT (in last 24 hrs):
	<u>10°C</u>	<u>2</u>	<u>20%</u>	<u>Ø</u>	<u>Ø</u>

### Record start time at each station

Visit No.:	Start Time:	End Time:
<u>1</u>	<u>8:45pm / 20:45</u>	<u>9:15</u>

Start Time: 8:53pm or 20:53

UTM: 17T, 851843E, 4762557N

Habitat: Pond / FOD

Water Present: Yes

Species	In*	Out**
AMTO		
BCFR		
BULL		
CHFR		
CGTR		
FOTO		
GRTR		
GRFR		
MIFR		
NLFR		
PIFR		
SPPE	<input checked="" type="checkbox"/>	
WOFR		

\* Check if species is calling from inside 100-metre station area.  
 \*\* Check if species is calling from outside 100-metre station area.

Station FG-3

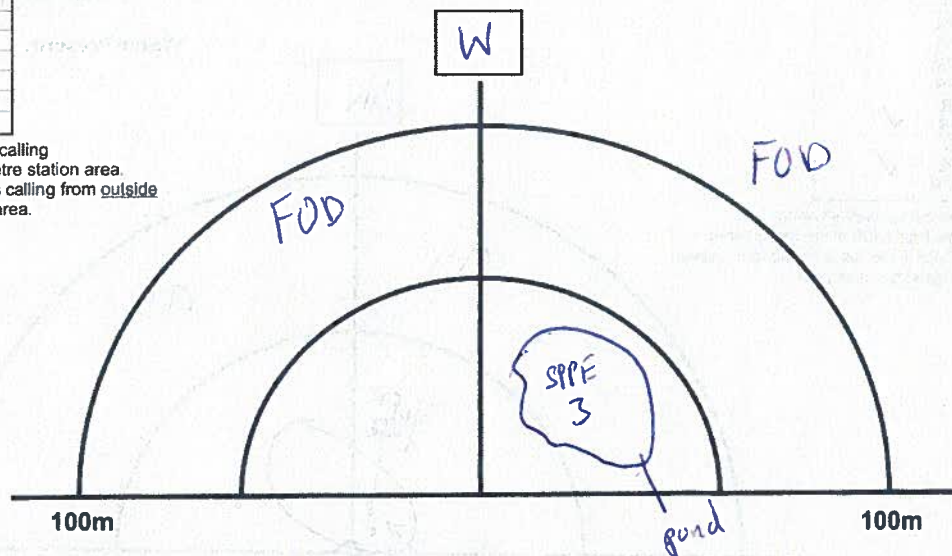

\* 2 bats seen flying over pond  
 \* AMW heard

Page 1 of 3

Signature: M. Straus  
 (Field Personnel)

Quality Control: This form is complete  & legible .

Signature: A. Bisher  
 (Project Manager)

Site: Adelaide

Date: 29-APR-2015 Amphibian Call Survey Observation Form

Species	In*	Out**
AMTO		
BCFR		
BULL		
CHFR		
CGTR		
FOTO		
GRTR		
GRFR		
MIFR		
NLFR		
PIFR		
SPPE		✓
WOFR		

\* Check if species is calling from inside 100-metre station area.  
 \*\* Check if species is calling from outside 100-metre station area.

Start Time: 9:00 pm or 2100

UTM: 17T, 451973 E, 4762539 N

Habitat: FOD

Water Present: Unknown - perhaps  
vernal poolings

Station F6-2

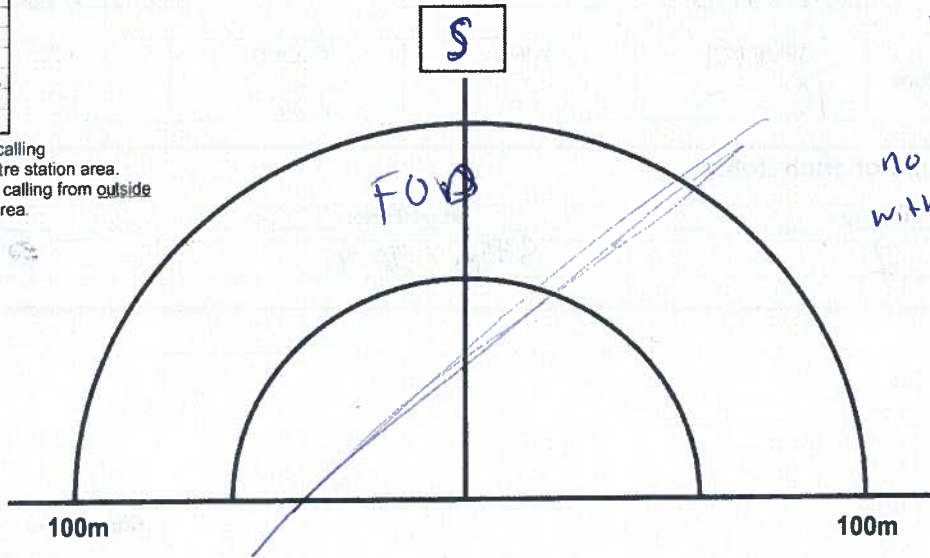

Species	In*	Out**
AMTO		
BCFR		
BULL		
CHFR		
CGTR		
FOTO		
GRTR		
GRFR		
MIFR		
NLFR	✓	
PIFR		
SPPE		✓
WOFR		

\* Check if species is calling from inside 100-metre station area.  
 \*\* Check if species is calling from outside 100-metre station area.

Start Time: 9:08 pm or 2108

UTM: 17T, 452142 E, 4762431 N

Habitat: Pond / Ag

Water Present: Yes

Station F6-1

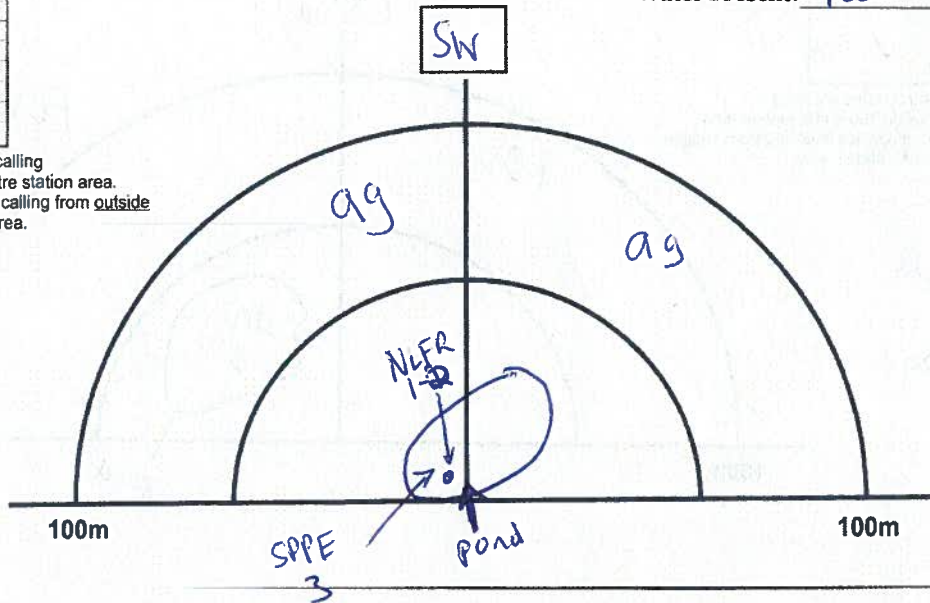

Page 23 of 23  
 Signature: [Signature]  
 (Field Personnel)

Quality Control: This form is complete & legible   
 Signature: [Signature]  
 (Project Manager)



Site: Adelaide

Date: 29 APRIL 2018 Amphibian Call Survey Observation Form

Start Time: 9:30 am or 21:30

UTM: 17T, 449587E, 4762989N

Habitat: FOD

Water Present: Unknown - possible  
 vernal poolings

Species	In*	Out**
AMTO		
BCFR		
BULL		
CHFR		
CGTR		
FOTO		
GRTR		
GRFR		
MIFR		
NLFR		
PIFR		
SPPE	✓	
WOFR		

\* Check if species is calling from inside 100-metre station area.  
 \*\* Check if species is calling from outside 100-metre station area.

Station F20

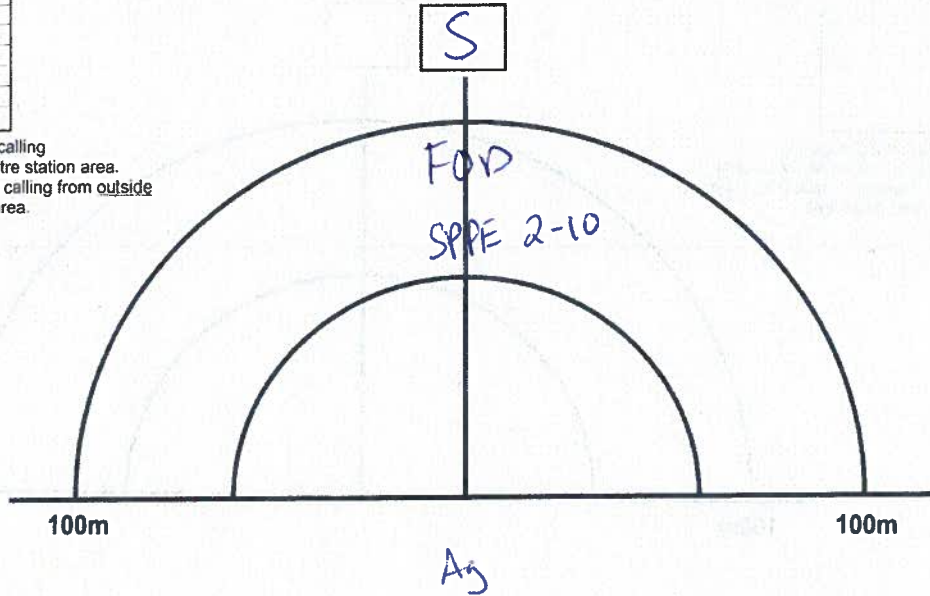

Start Time: 9:58 or 21:58

UTM: 17T, 447990E, 4763600

Habitat: Ag + Creek

Water Present: Yes

Species	In*	Out**
AMTO		
BCFR		
BULL		
CHFR	✓	✓
CGTR		
FOTO		
GRTR		
GRFR		
MIFR		
NLFR		
PIFR		
SPPE	✓	
WOFR		

\* Check if species is calling from inside 100-metre station area.  
 \*\* Check if species is calling from outside 100-metre station area.

Station F16

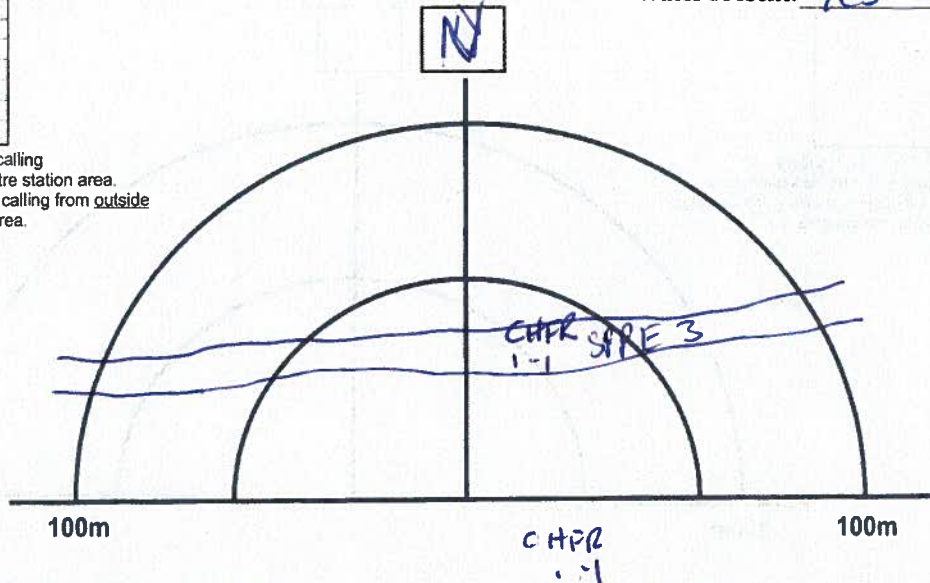

Page 33 of 33  
 Signature: [Signature]  
 (Field Personnel)

Quality Control: This form is complete  & legible   
 Signature: [Signature]  
 (Project Manager)  
 FORM 003 / REV. 2014-04-08



**Stantec Consulting Ltd.**  
 1 - 70 Southgate Drive  
 Guelph, ON  
 Canada N1G 4P5  
 Tel: (519) 836-6050  
 Fax: (519) 836-2493

## Amphibian Call Survey Observation Form

Project Number: 1100961010

Project Name: Adelaide

Date: 25-May-2015

Field Personnel: M. Straus / B. Miller

Weather Conditions:	TEMP (°C):	WIND:	CLOUD:	PPT:	PPT (in last 24 hrs):
	<u>20°C</u>	<u>3-4</u>	<u>75%</u>	<u>∅</u>	<u>∅</u>

### Record start time at each station

Visit No.:	Start Time:	End Time:
<u>2</u>	<u>20:00</u>	<u>21:00</u>

Species In*	Out**
AMTO	
BCFR	
BULL	
CHFR	
CGTR	
FOTO	
GRTR	✓
GRFR	✓
MIFR	
NLFR	
PIFR	
SPPE	✓
WOFR	

\* Check if species is calling from inside 100-metre station area.  
 \*\* Check if species is calling from outside 100-metre station area.

Fb-3  
 Station

Start Time: 20:00

UTM: 17T 451843.4762557

Habitat: POND

Water Present: Yes

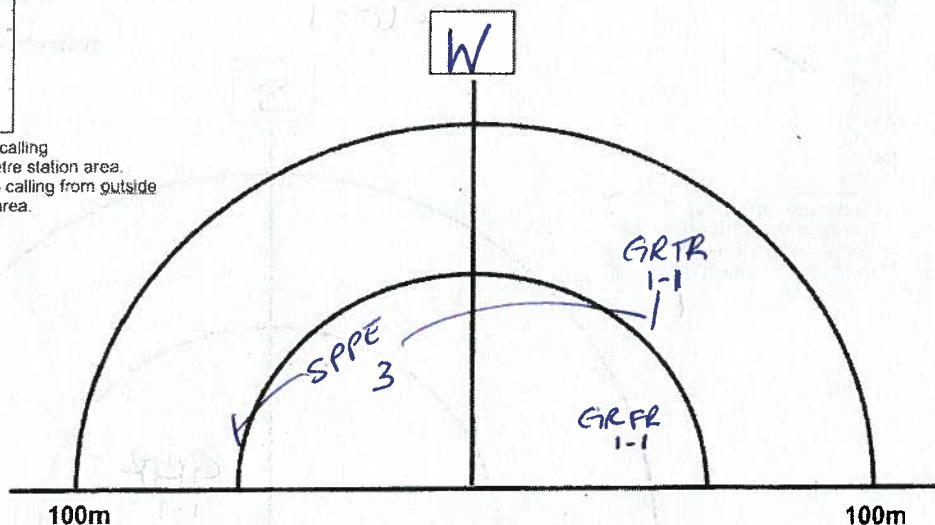

Site: Adelaide

Date: 25 May 2015 Amphibian Call Survey Observation Form

Start Time: 20:05

UTM: 19T451973

Habitat: Forest 4762539

Water Present: Unknown

*No calls*

Species	In*	Out**
AMTO		
BCFR		
BULL		
CHFR		
CGTR		
FOTO		
GRTR		
GRFR		
MIFR		
NLFR		
PIFR		
SPPE		
WOFR		

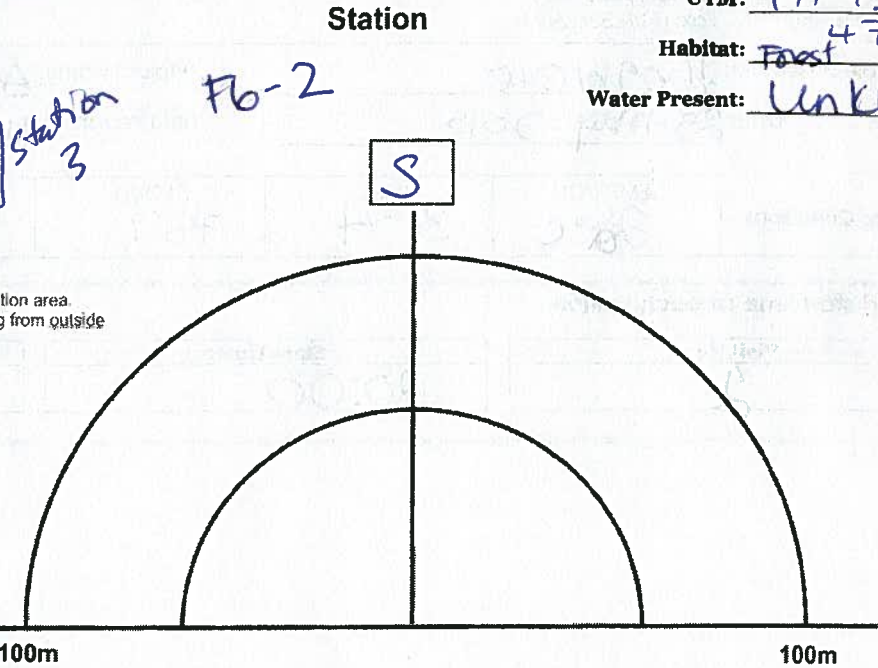

\* Check if species is calling from inside 100-metre station area.  
 \*\* Check if species is calling from outside 100-metre station area.

100m

100m

Start Time: 20:10

UTM: 452142-47629

Habitat: POND

Water Present: yes

Species	In*	Out**
AMTO		
BCFR		
BULL		
CHFR		
CGTR		
FOTO		
GRTR	✓	
GRFR		
MIFR		
NLFR		
PIFR		
SPPE		
WOFR		

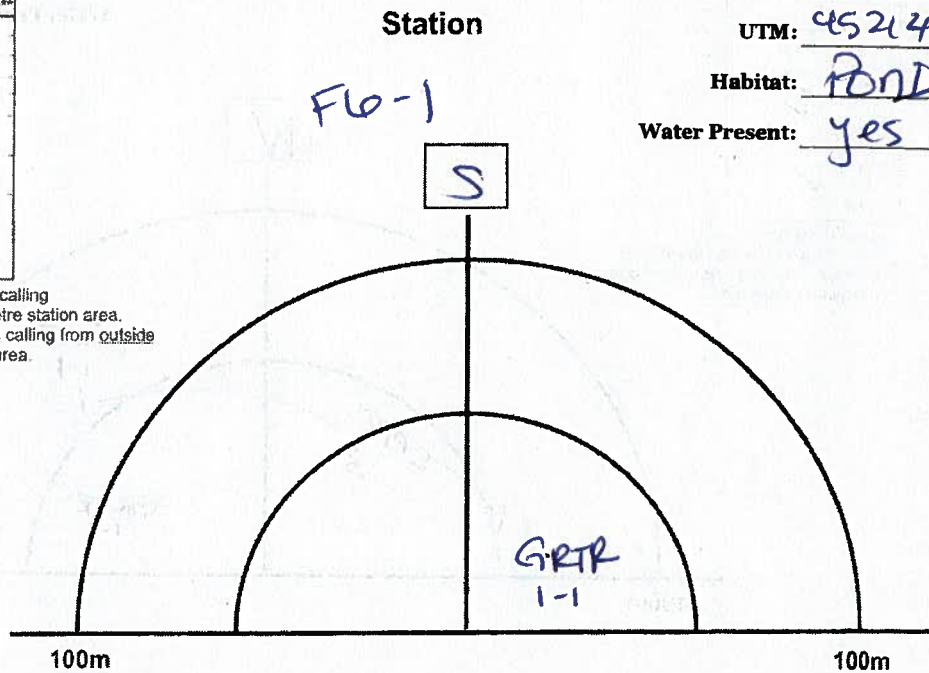

\* Check if species is calling from inside 100-metre station area.  
 \*\* Check if species is calling from outside 100-metre station area.

100m

100m

Signature: M Straus  
(Field Personnel)

Quality Control: This form is complete & legible

Signature: A Bieler  
(Project Manager)

Site: Adelaide

Date: 25-May-2015  
Amphibian Call Survey  
Observation Form

Start Time: 20:25

UTM: 449587.4762989

Habitat: ~~Forest~~ Forested

Water Present: Unknown

Species	In*	Out**
AMTO	<input checked="" type="checkbox"/>	<input type="checkbox"/>
BCFR	<input type="checkbox"/>	<input type="checkbox"/>
BULL	<input type="checkbox"/>	<input type="checkbox"/>
CHFR	<input type="checkbox"/>	<input type="checkbox"/>
CGTR	<input type="checkbox"/>	<input type="checkbox"/>
FOTO	<input type="checkbox"/>	<input type="checkbox"/>
GRTR	<input checked="" type="checkbox"/>	<input type="checkbox"/>
GRFR	<input type="checkbox"/>	<input type="checkbox"/>
MIFR	<input type="checkbox"/>	<input type="checkbox"/>
NLFR	<input type="checkbox"/>	<input type="checkbox"/>
PIFR	<input type="checkbox"/>	<input type="checkbox"/>
SPPE	<input type="checkbox"/>	<input type="checkbox"/>
WOFR	<input type="checkbox"/>	<input type="checkbox"/>

\* Check if species is calling from inside 100-metre station area.  
\*\* Check if species is calling from outside 100-metre station area.

Station  
F20

S

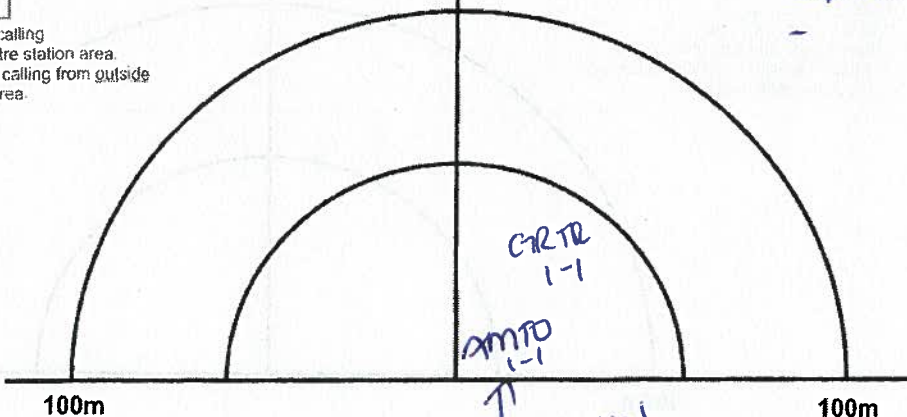

Bats x 2

Start Time: 20:43

UTM: 447990.4763600

Habitat: Ditch

Water Present: Yes

Species	In*	Out**
AMTO	<input type="checkbox"/>	<input checked="" type="checkbox"/>
BCFR	<input type="checkbox"/>	<input type="checkbox"/>
BULL	<input type="checkbox"/>	<input type="checkbox"/>
CHFR	<input type="checkbox"/>	<input type="checkbox"/>
CGTR	<input type="checkbox"/>	<input type="checkbox"/>
FOTO	<input type="checkbox"/>	<input type="checkbox"/>
GRTR	<input type="checkbox"/>	<input type="checkbox"/>
GRFR	<input type="checkbox"/>	<input type="checkbox"/>
MIFR	<input type="checkbox"/>	<input type="checkbox"/>
NLFR	<input type="checkbox"/>	<input type="checkbox"/>
PIFR	<input type="checkbox"/>	<input type="checkbox"/>
SPPE	<input type="checkbox"/>	<input type="checkbox"/>
WOFR	<input type="checkbox"/>	<input type="checkbox"/>

\* Check if species is calling from inside 100-metre station area.  
\*\* Check if species is calling from outside 100-metre station area.

Station  
F16

N

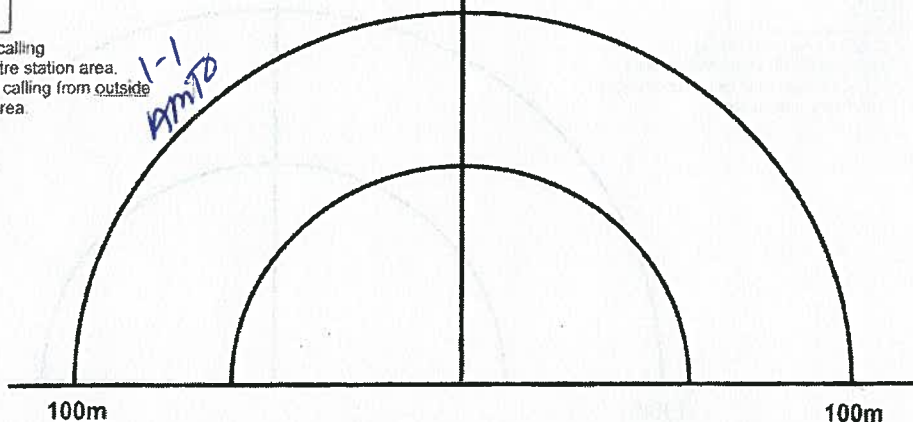

Signature: M Strauss  
(Field Personnel)

Quality Control: This form is complete  & legible

Signature: A Brakel  
(Project Manager)



**Stantec Consulting Ltd.**  
 1 - 70 Southgate Drive  
 Guelph, ON  
 Canada N1G 4P5  
 Tel: (519) 836-6050  
 Fax: (519) 836-2493

## Amphibian Call Survey Observation Form

Project Number: 160961010

Project Name: Adelaide

Date: 22 June 2015

Field Personnel: M. Straus / B. Miller

<b>Weather Conditions:</b>	TEMP (°C): <u>20°</u>	WIND: <u>4</u>	CLOUD: <u>50%</u>	PPT: <u>∅</u>	PPT (in last 24 hrs): <u>Rain</u>
----------------------------	--------------------------	-------------------	----------------------	------------------	--------------------------------------

### Record start time at each station

<b>Visit No.:</b> <u>3</u>	<b>Start Time:</b> <u>21:30</u>	<b>End Time:</b> <u>22:30</u>
-------------------------------	------------------------------------	----------------------------------

21

Start Time: 21:30

UTM: 17T 447990 47636

Habitat: Creek

Water Present: Yes

Species	In*	Out**
AMTO		
BCFR		
BULL		
CHFR		
CGTR		
FOTO		
GRTR	<input checked="" type="checkbox"/>	<input checked="" type="checkbox"/>
GRFR		
MIFR		
NLFR		
PIFR		
SPPE		
WOFR		

\* Check if species is calling from inside 100-metre station area.  
 \*\* Check if species is calling from outside 100-metre station area.

Station Flb

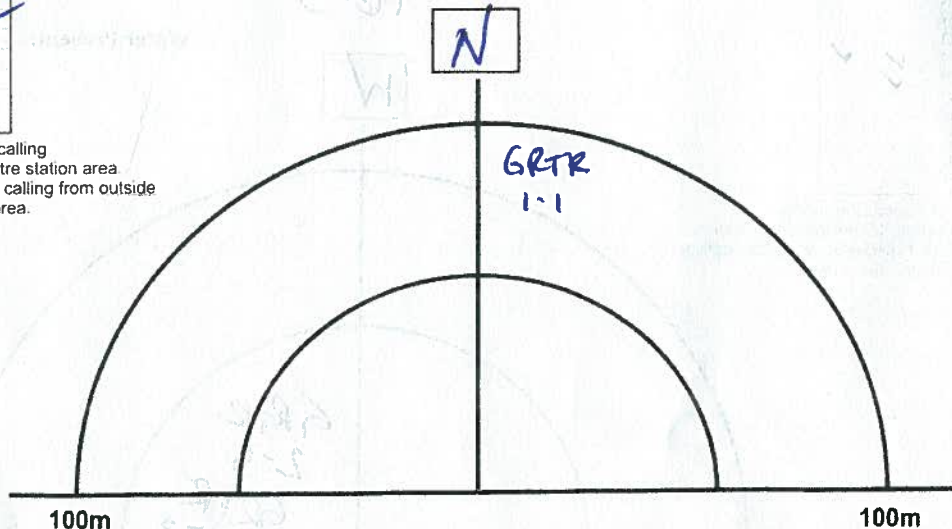

Page 1 of 3  
 Signature: M. Straus  
 (Field Personnel)

Quality Control: This form is complete  & legible   
 Signature: B. Miller  
 (Project Manager)

Site: Adelaide

Date: June 22, 2015 Amphibian Call Survey Observation Form

Start Time: 9:53 PM

UTM: 449587.4762989

Habitat: Forested

Water Present: Unknown

Station F20.

Species	In*	Out**
AMTO		
BCFR		
BULL		
CHFR		
CGTR		
FOTO		
GRTR	✓	
GRFR		
MIFR		
NLFR		
PIFR		
SPPE		
WOFR		

\* Check if species is calling from inside 100-metre station area.  
 \*\* Check if species is calling from outside 100-metre station area.

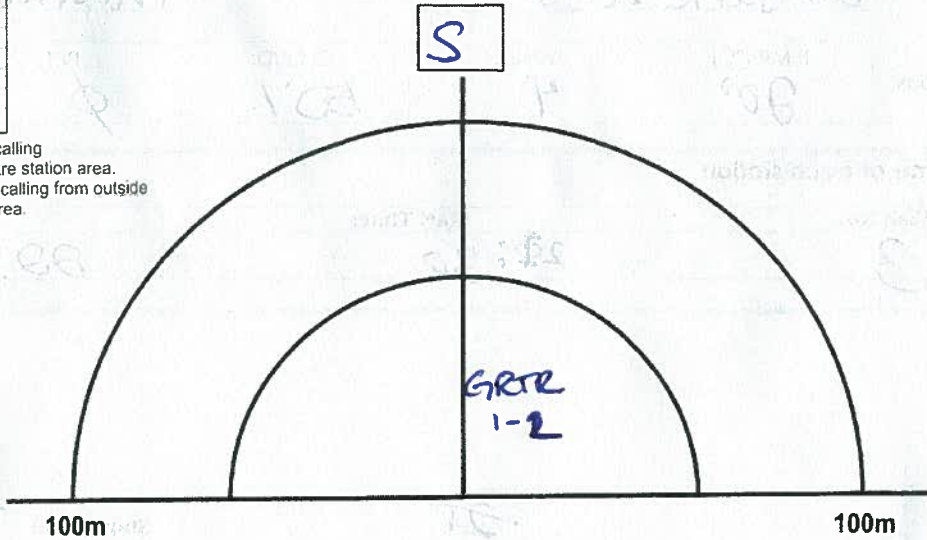

Start Time: 10:15 PM

UTM: 451943.4762557

Habitat: Pond

Water Present: Yes

Station F6-3

Species	In*	Out**
AMTO		
BCFR		
BULL		
CHFR		
CGTR		
FOTO		
GRTR	✓	✓
GRFR	✓	
MIFR		
NLFR		
PIFR		
SPPE		
WOFR		

\* Check if species is calling from inside 100-metre station area.  
 \*\* Check if species is calling from outside 100-metre station area.

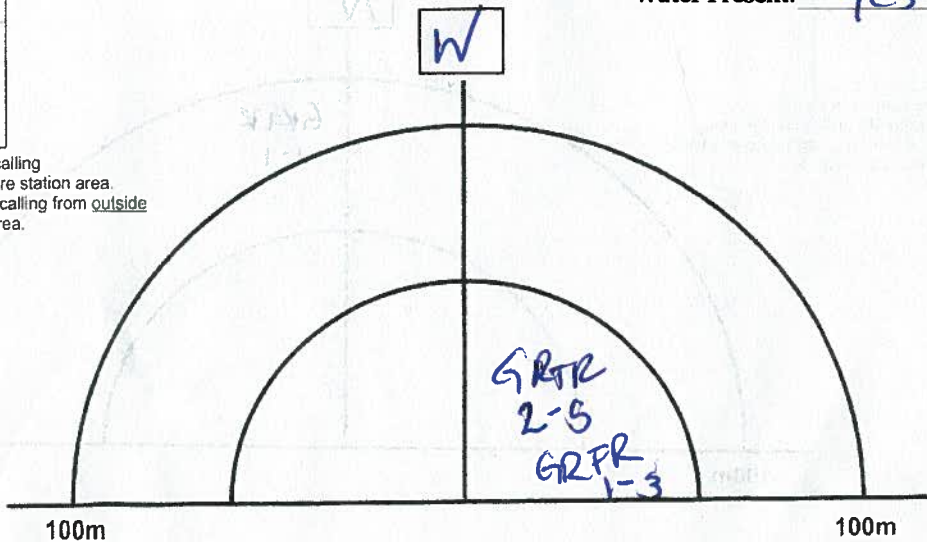

Signature: \_\_\_\_\_

[Signature]  
(Field Personnel)

Quality Control: This form is complete  & legible

Signature: \_\_\_\_\_

[Signature]  
(Project Manager)

Site: Adelaide

Date: June 24 2015  
 Amphibian Call Survey  
 Observation Form

Start Time: 10:20PM

UTM: 451973.4762539

Habitat: Forest

Water Present: Unknown

Species	In*	Out**
AMTO		
BCFR		
BULL		
CHFR		
CGTR		
FOTO		
GRTR		✓
GRFR		
MIFR		
NLFR		
PIFR		
SPPE		
WOFR		

\* Check if species is calling from inside 100-metre station area.  
 \*\* Check if species is calling from outside 100-metre station area.

Station  
Fb-2

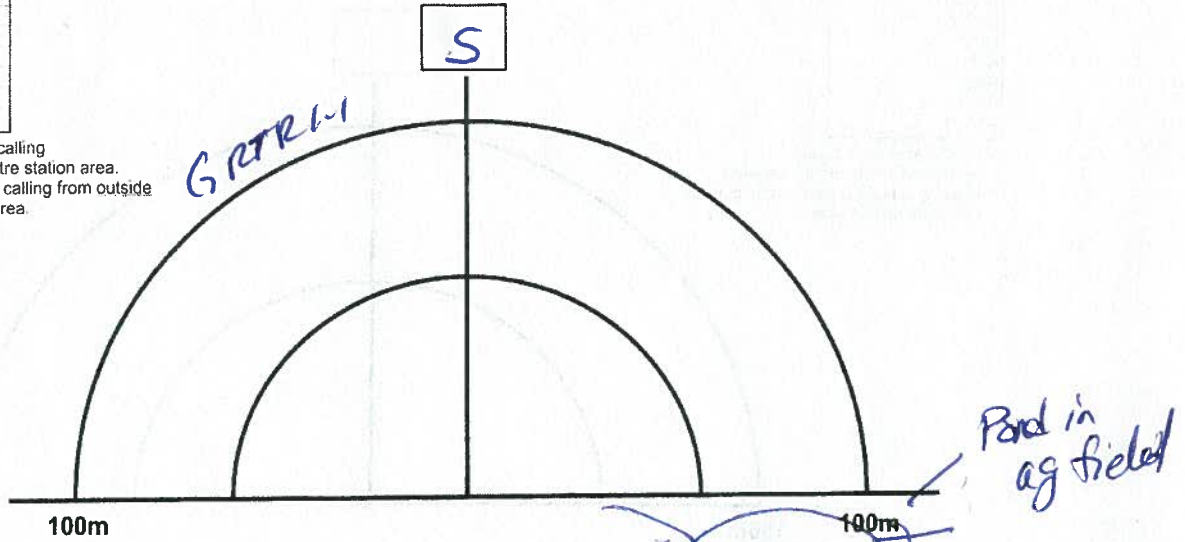

Start Time: 10:27

UTM: 452142 4762431

Habitat: Pond

Water Present: Yes

Species	In*	Out**
AMTO		
BCFR		
BULL		
CHFR		
CGTR		
FOTO		
GRTR	✓	
GRFR		
MIFR		
NLFR		
PIFR		
SPPE		
WOFR		

\* Check if species is calling from inside 100-metre station area.  
 \*\* Check if species is calling from outside 100-metre station area.

Station  
Fb-1

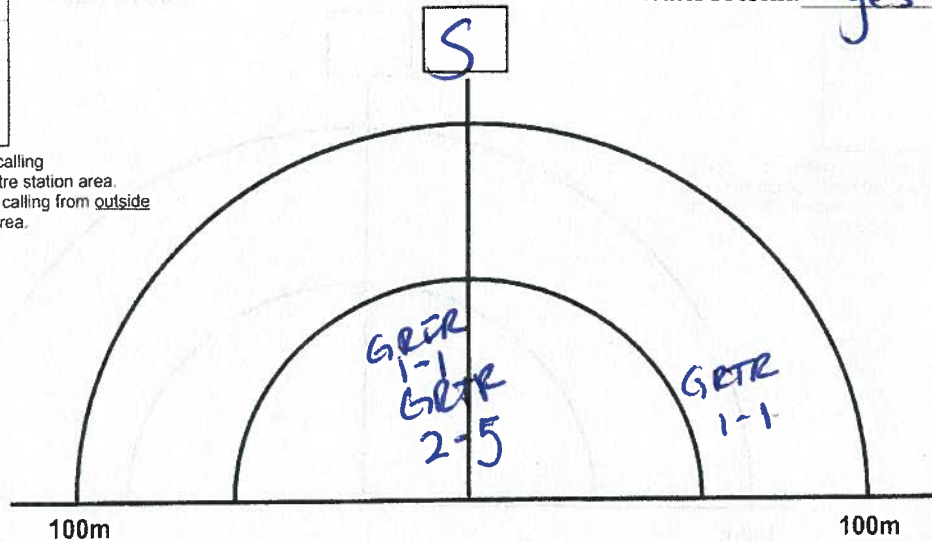

Signature: M Strauss  
 (Field Personnel)

Quality Control: This form is complete & legible   
 Signature: H Bichel  
 (Project Manager)

W:\active\60960710\drawing\WXD\Terrestrial\Post\_Con\_Monitoring\2015\160960710\_Post\_Con\_Monitoring\_EEMP\_TurbineSubset\_20150417.mxd  
 Revised: 2015-04-17 By: dharvey

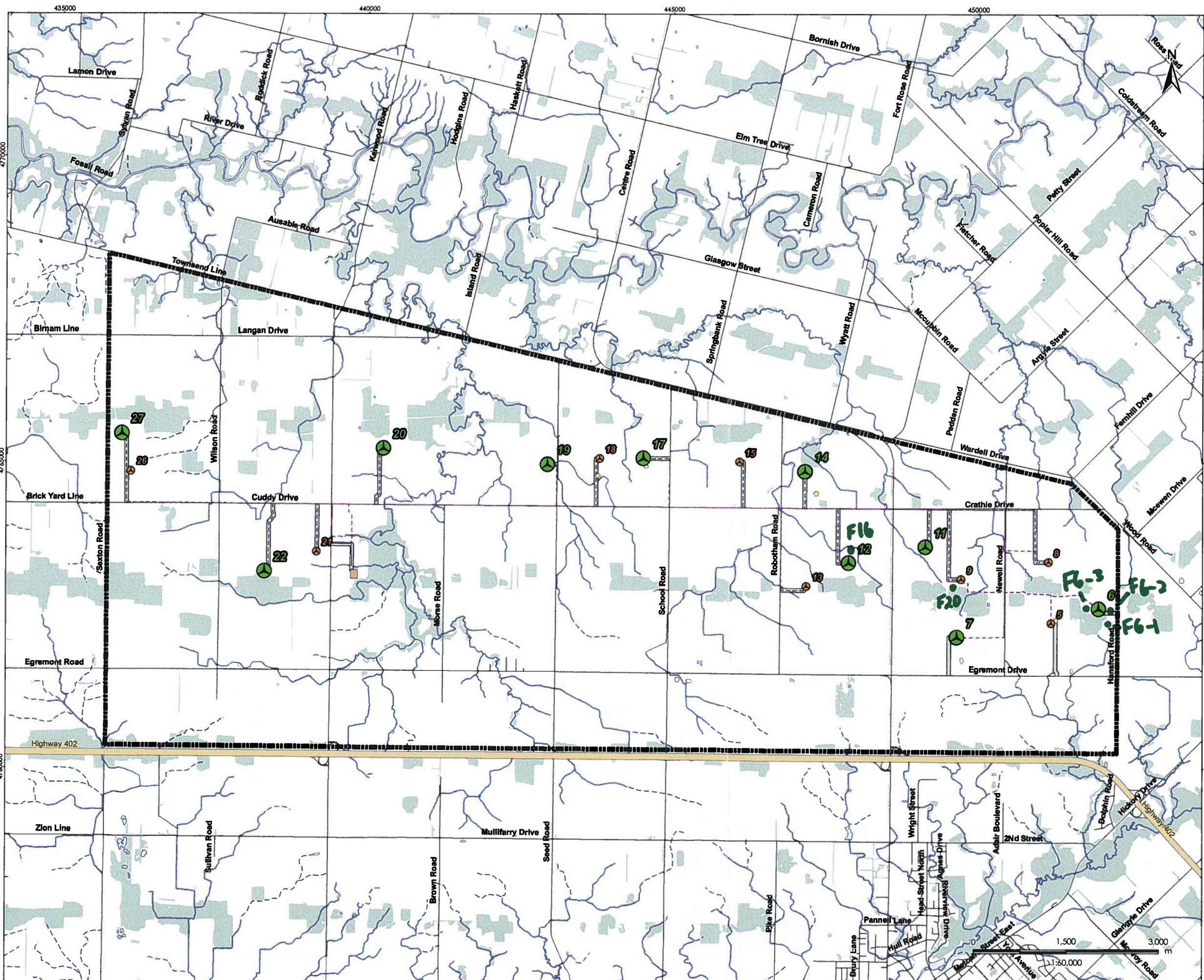

- Legend**
- Project Boundary
  - Turbine Subset
  - Project Components**
  - MET Tower
  - Turbine Location
  - Access Road
  - Collector Line
  - Substation Constructible Area
  - Existing Features**
  - Expressway / Highway
  - Road
  - Watercourse
  - Constructed Drain
  - Waterbody



- Notes**
1. Coordinate System: NAD 1983 UTM Zone 17N
  2. Base features produced under license with the Ontario Ministry of Natural Resources © Queen's Printer for Ontario, 2013.

April 2015  
160960710

Client/Project  
Suncor Energy  
Adelaide Wind Project

Figure No.  
**1**

Title  
**Post-construction Monitoring  
EEMP Turbine Subset**



F16	17T	0447990	4763600
F20	17T	0449587	4762989
F6-1	17T	0452142	4762431
F6-2	17T	0451973	4762539
F6-3	17T	0451843	4762557

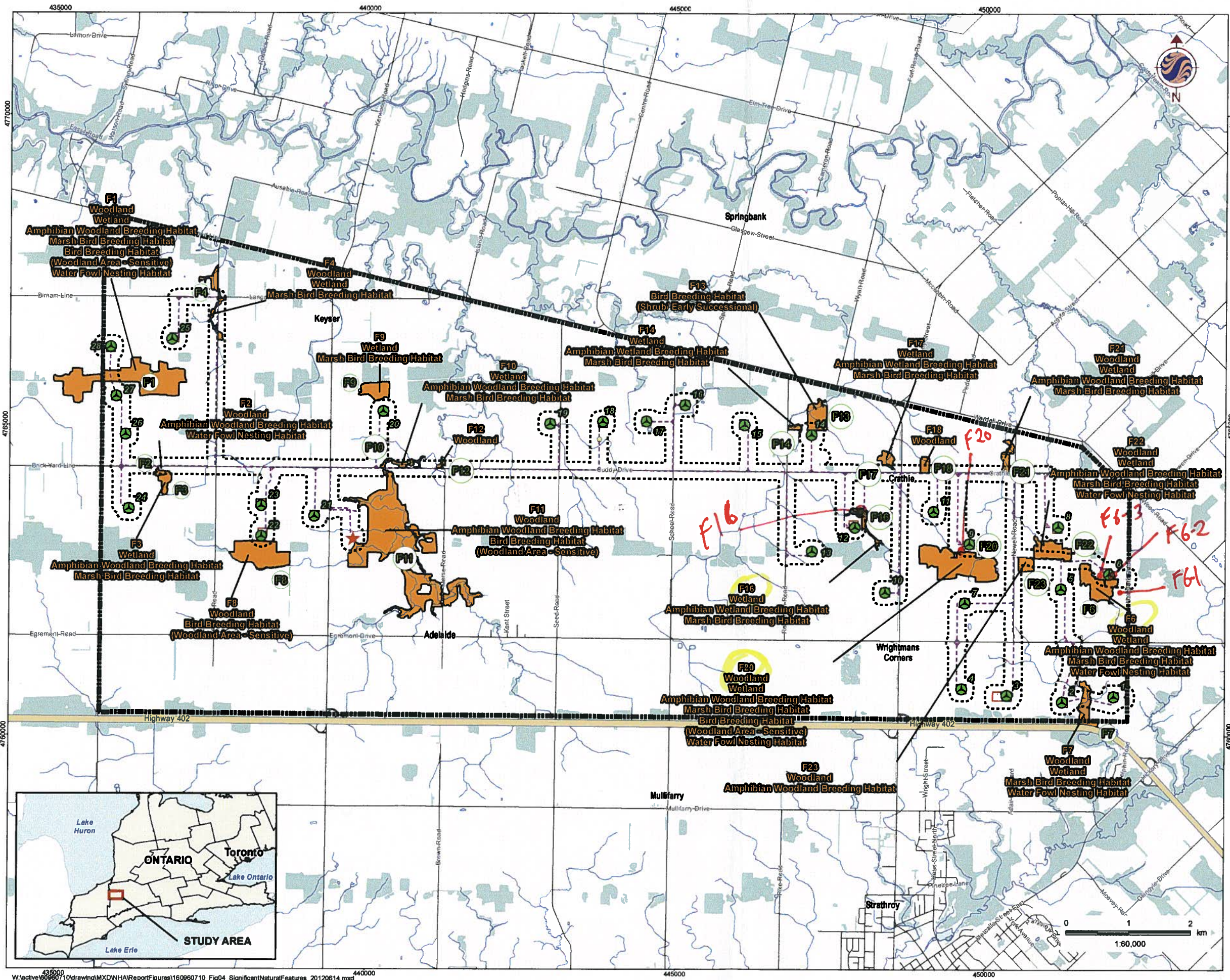

### Legend

- Project Boundary
- 120m Zone of Investigation
- Proposed Turbine Location
- MET Tower
- Substation
- Access Roads
- Underground Collector
- Truck Turning ROW
- Turbine Laydown Area
- Expressway / Highway
- Road
- Watercourse
- Wooded Area
- Waterbody
- Significant Natural Feature (Stantec)

- ### Notes
1. Coordinate System: NAD 1983 UTM Zone 17N
  2. Base features produced under license with the Ontario Ministry of Natural Resources © Queen's Printer for Ontario, 2011.



**Stantec**

June 2012  
160960710

Client/Project  
Suncor Energy  
Adelaide Wind Project

Figure No.  
**4.0** **DRAFT**

Title  
**Significant Natural Features Overview**

# APPENDIX H: NOTIFICATIONS

---

**From:** Taylor, Andrew  
**Sent:** Thursday, June 11, 2015 11:55 AM  
**To:** Jim.beal@ontario.ca  
**Cc:** Kozak, Mark  
**Subject:** Raptor Notification - Adelaide Wind Project

Hello Jim,

This is a notification to inform you that a Red-tailed Hawk fatality was observed this morning during the regular mortality monitoring at the Suncor Energy Adelaide Wind Project as part of the regular post-construction mortality monitoring. Details of the fatality are provided below.

If you have any questions, please don't hesitate to contact me,

Regards,  
Andrew

Date: June 11, 2015  
Location: Strathroy, ON  
Turbine: 11  
UTM: 17T 0449183 4763594  
Species: Red-tailed Hawk

**Andrew Taylor**

Senior Ecologist  
Stantec  
1-70 Southgate Drive Guelph ON N1G 4P5  
Phone: (519) 780-8122  
Cell: (519) 820-6149  
Fax: (519) 836-2493  
andrew.taylor@stantec.com



The content of this email is the confidential property of Stantec and should not be copied, modified, retransmitted, or used for any purpose except with Stantec's written authorization. If you are not the intended recipient, please delete all copies and notify us immediately.

 Please consider the environment before printing this email.



## **CONFIRMATION OF REGISTRATION**

Form Name: Notice of Possession

Date Registration Filed: 06/12/2015

Confirmation ID: M-101-9864800294

Version Number: 001

Update Date:

STANTEC CONSULTING LTD.

70 Southgate DR , SUITE 1  
Guelph, ON N1G4H5

Dear Sir/Madam,

You have registered under section 2 or 3.2 of Ontario Regulation 666/98 under the *Fish and Wildlife Conservation Act, 1997* and/or subsection 23.15(6) of Ontario Regulation 242/08 under the *Endangered Species Act, 2007*.

Your Notice of Possession form has been received by the Ministry of Natural Resources for the possession of the following:

Species Name: Red-tailed Hawk

Condition: Whole

Number Acquired: 1

You may be required to show this record for certain activities.

Please refer to Ontario Regulations 666/98 and/or 242/08 for requirements that apply to your activity.

Any questions related to this registration and/or the Natural Resources Registry should be directed to:

Registry and Approval Services Centre  
Ministry of Natural Resources  
300 Water Street  
Peterborough, ON, K9J8M5  
Toll-free: 1-855-613-4256  
E-mail: [mnr.rasc@ontario.ca](mailto:mnr.rasc@ontario.ca)

NEW

---

---

**Part 1: Registrant Contact Information**

---

Legal/Business Name	Stantec Consulting Ltd.
Organization Type	
CRA Business No.	887251288

---

Part 1: Registrant Information

Contact Person

Last Name Kopysh		Middle Name Collette	
First Name Nicole		Name Suffix	Title MS
Primary Telephone No. (519)8366050	Ext. 263	Alternate Phone No.	Ext. Fax No.

E-mail Address  
nicole.kopysh@stantec.com

Mailing Address

Street No. 70	Street Name (include Street Type and Street Direction) Southgate DR		
City/Town/Municipality Guelph		Province/State ON	Postal/Zip Code N1G4H5
Unit Type SUITE	Unit Number 1	Delivery Type	Delivery #

**Physical Civic Address**

Street No. 70	Street Name (include Street Type and Street Direction) Southgate DR		
Unit Type SUITE		City/Town/Municipality Guelph	
Unit Number 1		Province/State ON	Postal/Zip Code N1G4H5

**Physical Surveyed Address**

Lot No.	Concession	Geographic Township
---------	------------	---------------------

Part Lot Description

Additional Location Information

---

**Part 2: Site Information**

---

Site Name

1. NAICS Code

2. NAICS Code

3. NAICS Code

Site Contact

Last Name

First Name

Telephone No.

Ext.

Alternate Phone

Ext.

Fax Number

Email

---

**Part 3: Activity Information**

---

**3.1 Registration Information**

This form is to be used to register:

- Possession of a carcass or part of a carcass for certain wildlife species regulated under the Fish and Wildlife Conservation Act and/or
- Possession of a dead species at risk regulated under the Endangered Species Act for the purpose of carrying out a scientific or educational activity.

You are only required to register the acquisition of certain species. For a list of species, please go [here](#).If you need help identifying the species, select [this link](#).

Please confirm that your circumstance meets the criteria in the Regulation(s) as described above and that you would like to proceed with registration:\*

 Yes  No

---

**3.2 Activity Related Information****3.2.1 Species Information**

a) Type of species

Bird

b) Species

Red-tailed Hawk

c) Condition of animal or plant:

Whole

**3.2.2 Additional Information**

a) If the species has been previously registered, please enter the PRIOR Notice of Possession Confirmation ID (e.g. if it was transferred to you from someone else or if you misidentified the species in a previous registration):

b) Date of acquisition (mm/dd/yyyy)\*

06/11/2015

c) Number acquired\*

1

d) Circumstance of acquisition (If the species is a Species at Risk, then please select 'Other' and describe the education or scientific activity)\*

Others

e) Specify 'other' circumstance\*

Wind turbine mortality at Adelaide Wind Facility recovered during post-construction monitoring program

f) Name of municipality and unorganized territory where it was acquired

ADELAIDE (GEOGRAPHIC TOWNSHIP)

g) Location details (e.g. closest roadway or intersection)

17T, E0449183, N4763594, Crathie Drive and Centre Road



Part 4 - Verification of Information

---

I hereby declare that the information being provided through the Registry is complete and accurate, and I am aware that providing incomplete, false or misleading information shall result in the form being deemed to have not been submitted and this registration being invalid. I am aware that the activity I am registering for is subject to additional rules set out in regulation and I agree to follow those rules.

I, the undersigned, hereby declare that I have the authority to act on behalf of the corporation or other legal entity.

---

Last Name Kopysh	First Name Nicole
Company Name Stantec Consulting Ltd.	
Job Title Project Manager	Date (yyyy/mm/dd) 2015/06/12

---

---

**From:** Straus, Melissa  
**Sent:** Tuesday, June 16, 2015 6:41 PM  
**To:** 'Jim.beal@ontario.ca'  
**Cc:** 'Kozak, Mark'; Taylor, Andrew; jweir@suncor.com  
**Subject:** Raptor Notification #2- Adelaide Wind Project

Hello Jim,

This is a notification to inform you that a Red-tailed Hawk fatality was observed yesterday during the regular mortality monitoring at the Suncor Energy Adelaide Wind Project as part of the post-construction mortality monitoring program. We have registered the fatality using the online Ontario database.

Details of the fatality are provided below.

If you have any questions, please don't hesitate to contact me,

Date: June 15, 2015  
Location: Strathroy, ON  
Turbine: 6  
UTM: 17T 051953 4762617  
Species: Red-tailed Hawk

**Melissa Straus, M.Sc.**

Terrestrial Ecologist  
Stantec  
70 Southgate Drive, Suite 1 Guelph ON N1G 4P5  
Phone: (519) 780-8103  
Cell: (226) 971-2704  
Fax: (519) 836-2493  
Melissa.Straus@stantec.com



**Celebrating 60 years of community, creativity, and client relationships.**

The content of this email is the confidential property of Stantec and should not be copied, modified, retransmitted, or used for any purpose except with Stantec's written authorization. If you are not the intended recipient, please delete all copies and notify us immediately.

 Please consider the environment before printing this email.



## **CONFIRMATION OF REGISTRATION**

Form Name: Notice of Possession

Date Registration Filed: 06/15/2015

Confirmation ID: M-101-9868266733

Version Number: 001

Update Date:

STANTEC CONSULTING LTD.

70 Southgate DR , SUITE 1  
Guelph, ON N1G4H5

Dear Sir/Madam,

You have registered under section 2 or 3.2 of Ontario Regulation 666/98 under the *Fish and Wildlife Conservation Act, 1997* and/or subsection 23.15(6) of Ontario Regulation 242/08 under the *Endangered Species Act, 2007*.

Your Notice of Possession form has been received by the Ministry of Natural Resources for the possession of the following:

Species Name: Red-tailed Hawk

Condition: Whole

Number Acquired: 1

You may be required to show this record for certain activities.

Please refer to Ontario Regulations 666/98 and/or 242/08 for requirements that apply to your activity.

Any questions related to this registration and/or the Natural Resources Registry should be directed to:

Registry and Approval Services Centre  
Ministry of Natural Resources  
300 Water Street  
Peterborough, ON, K9J8M5  
Toll-free: 1-855-613-4256  
E-mail: [mnr.rasc@ontario.ca](mailto:mnr.rasc@ontario.ca)

NEW

---

---

**Part 1: Registrant Contact Information**

---

Legal/Business Name	Stantec Consulting Ltd.
Organization Type	
CRA Business No.	887251288

---

Part 1: Registrant Information

Contact Person

Last Name Kopysh		Middle Name Collette	
First Name Nicole		Name Suffix	Title MS
Primary Telephone No. (519)8366050	Ext. 263	Alternate Phone No.	Ext. Fax No.

E-mail Address  
nicole.kopysh@stantec.com

Mailing Address

Street No. 70	Street Name (include Street Type and Street Direction) Southgate DR		
City/Town/Municipality Guelph		Province/State ON	Postal/Zip Code N1G4H5
Unit Type SUITE	Unit Number 1	Delivery Type	Delivery #

Physical Civic Address

Street No. 70	Street Name (include Street Type and Street Direction) Southgate DR		
Unit Type SUITE		City/Town/Municipality Guelph	
Unit Number 1		Province/State ON	Postal/Zip Code N1G4H5

Physical Surveyed Address

Lot No.	Concession	Geographic Township
---------	------------	---------------------

Part Lot Description

Additional Location Information

---

**Part 2: Site Information**

---

Site Name

1. NAICS Code

2. NAICS Code

3. NAICS Code

Site Contact

Last Name

First Name

Telephone No.

Ext.

Alternate Phone

Ext.

Fax Number

Email

---

**Part 3: Activity Information**

---

**3.1 Registration Information**

This form is to be used to register:

- Possession of a carcass or part of a carcass for certain wildlife species regulated under the Fish and Wildlife Conservation Act and/or
- Possession of a dead species at risk regulated under the Endangered Species Act for the purpose of carrying out a scientific or educational activity.

You are only required to register the acquisition of certain species. For a list of species, please go [here](#).If you need help identifying the species, select [this link](#).

Please confirm that your circumstance meets the criteria in the Regulation(s) as described above and that you would like to proceed with registration:\*

 Yes  No

---

**3.2 Activity Related Information****3.2.1 Species Information**

- |                                  |                 |
|----------------------------------|-----------------|
| a) Type of species               | Bird            |
| b) Species                       | Red-tailed Hawk |
| c) Condition of animal or plant: | Whole           |

**3.2.2 Additional Information**

a) If the species has been previously registered, please enter the PRIOR Notice of Possession Confirmation ID (e.g. if it was transferred to you from someone else or if you misidentified the species in a previous registration):

b) Date of acquisition (mm/dd/yyyy)\* 06/15/2015

c) Number acquired\* 1

d) Circumstance of acquisition (If the species is a Species at Risk, then please select 'Other' and describe the education or scientific activity)\* Others

e) Specify 'other' circumstance\* Wind turbine mortality, recovered as part of the post-construction mortality monitoring program at the Adelaide Wind Project

f) Name of municipality and unorganized territory where it was acquired

g) Location details (e.g. closest roadway or intersection) 17T 451953 4762617; Egremont Drive and Hansford Road, Strathroy, Ontario

Part 4 - Verification of Information

---

I hereby declare that the information being provided through the Registry is complete and accurate, and I am aware that providing incomplete, false or misleading information shall result in the form being deemed to have not been submitted and this registration being invalid. I am aware that the activity I am registering for is subject to additional rules set out in regulation and I agree to follow those rules.

I, the undersigned, hereby declare that I have the authority to act on behalf of the corporation or other legal entity.

---

Last Name Kopysh	First Name Nicole
Company Name Stantec Consulting Ltd.	
Job Title Project Manager	Date (yyyy/mm/dd) 2015/06/15

---

---

**From:** Straus, Melissa  
**Sent:** Friday, June 19, 2015 1:28 PM  
**To:** 'Jim.beal@ontario.ca'  
**Cc:** 'Kozak, Mark'; Taylor, Andrew; jweir@suncor.com  
**Subject:** Raptor Notification #3- Adelaide Wind Project

Hello Jim,

This is a notification to inform you that two (2) Turkey Vulture fatalities were observed yesterday during the regular mortality monitoring at the Suncor Energy Adelaide Wind Project as part of the post-construction mortality monitoring program. We have registered the fatalities using the online Ontario database.

Details of the fatalities are provided below.

Date: June 18, 2015  
Location: Strathroy, ON

Fatality 1  
Turbine: 27  
UTM: 17T 0435959 4765488  
Species: Turkey Vulture

Fatality 2  
Turbine: 27  
UTM: 17T 0435912 4765441  
Species: Turkey Vulture

If you have any questions, please don't hesitate to contact me.

**Melissa Straus, M.Sc.**

Terrestrial Ecologist  
Stantec  
70 Southgate Drive, Suite 1 Guelph ON N1G 4P5  
Phone: (519) 780-8103  
Cell: (226) 971-2704  
Fax: (519) 836-2493  
Melissa.Straus@stantec.com



**Celebrating 60 years of community, creativity, and client relationships.**

The content of this email is the confidential property of Stantec and should not be copied, modified, retransmitted, or used for any purpose except with Stantec's written authorization. If you are not the intended recipient, please delete all copies and notify us immediately.

 Please consider the environment before printing this email.





## **CONFIRMATION OF REGISTRATION**

Form Name: Notice of Possession

Date Registration Filed: 06/18/2015

Confirmation ID: M-101-6870519363

Version Number: 001

Update Date:

STANTEC CONSULTING LTD.

70 Southgate DR , SUITE 1  
Guelph, ON N1G4H5

Dear Sir/Madam,

You have registered under section 2 or 3.2 of Ontario Regulation 666/98 under the *Fish and Wildlife Conservation Act, 1997* and/or subsection 23.15(6) of Ontario Regulation 242/08 under the *Endangered Species Act, 2007*.

Your Notice of Possession form has been received by the Ministry of Natural Resources for the possession of the following:

Species Name: Turkey Vulture

Condition: Whole

Number Acquired: 2

You may be required to show this record for certain activities.

Please refer to Ontario Regulations 666/98 and/or 242/08 for requirements that apply to your activity.

Any questions related to this registration and/or the Natural Resources Registry should be directed to:

Registry and Approval Services Centre  
Ministry of Natural Resources  
300 Water Street  
Peterborough, ON, K9J8M5  
Toll-free: 1-855-613-4256  
E-mail: [mnr.rasc@ontario.ca](mailto:mnr.rasc@ontario.ca)

NEW

---

---

**Part 1: Registrant Contact Information**

---

Legal/Business Name	Stantec Consulting Ltd.
Organization Type	
CRA Business No.	887251288

---

Part 1: Registrant Information

Contact Person

Last Name Kopysh		Middle Name Collette	
First Name Nicole		Name Suffix	Title MS
Primary Telephone No. (519)8366050	Ext. 263	Alternate Phone No.	Ext. Fax No.

E-mail Address  
nicole.kopysh@stantec.com

Mailing Address

Street No. 70	Street Name (include Street Type and Street Direction) Southgate DR		
City/Town/Municipality Guelph		Province/State ON	Postal/Zip Code N1G4H5
Unit Type SUITE	Unit Number 1	Delivery Type	Delivery #

Physical Civic Address

Street No. 70	Street Name (include Street Type and Street Direction) Southgate DR		
Unit Type SUITE		City/Town/Municipality Guelph	
Unit Number 1		Province/State ON	Postal/Zip Code N1G4H5

Physical Surveyed Address

Lot No.	Concession	Geographic Township
---------	------------	---------------------

Part Lot Description

Additional Location Information

---

**Part 2: Site Information**

---

Site Name

1. NAICS Code

2. NAICS Code

3. NAICS Code

Site Contact

Last Name

First Name

Telephone No.

Ext.

Alternate Phone

Ext.

Fax Number

Email

---

**Part 3: Activity Information**

---

**3.1 Registration Information**

This form is to be used to register:

- Possession of a carcass or part of a carcass for certain wildlife species regulated under the Fish and Wildlife Conservation Act and/or
- Possession of a dead species at risk regulated under the Endangered Species Act for the purpose of carrying out a scientific or educational activity.

You are only required to register the acquisition of certain species. For a list of species, please go [here](#).If you need help identifying the species, select [this link](#).

Please confirm that your circumstance meets the criteria in the Regulation(s) as described above and that you would like to proceed with registration:\*

 Yes  No

---

**3.2 Activity Related Information****3.2.1 Species Information**

- |                                  |                |
|----------------------------------|----------------|
| a) Type of species               | Bird           |
| b) Species                       | Turkey Vulture |
| c) Condition of animal or plant: | Whole          |

**3.2.2 Additional Information**

a) If the species has been previously registered, please enter the PRIOR Notice of Possession Confirmation ID (e.g. if it was transferred to you from someone else or if you misidentified the species in a previous registration):

b) Date of acquisition (mm/dd/yyyy)\* 06/18/0015

c) Number acquired\* 2

d) Circumstance of acquisition (If the species is a Species at Risk, then please select 'Other' and describe the education or scientific activity)\* Others

e) Specify 'other' circumstance\* Mortalities identified during post-construction monitoring program at the Adelaide Wind Project

f) Name of municipality and unorganized territory where it was acquired

g) Location details (e.g. closest roadway or intersection) Turbine 27; Sexton Road and Cuddy Drive, Strathroy Ontario; UTM: 17T 435912 4765441

Part 4 - Verification of Information

---

I hereby declare that the information being provided through the Registry is complete and accurate, and I am aware that providing incomplete, false or misleading information shall result in the form being deemed to have not been submitted and this registration being invalid. I am aware that the activity I am registering for is subject to additional rules set out in regulation and I agree to follow those rules.

I, the undersigned, hereby declare that I have the authority to act on behalf of the corporation or other legal entity.

---

Last Name Kopysh	First Name Nicole
Company Name Stantec Consulting Ltd.	
Job Title Project Manager	Date (yyyy/mm/dd) 2015/06/18

---

---

**From:** Straus, Melissa  
**Sent:** Monday, June 22, 2015 2:27 PM  
**To:** 'Jim.beal@ontario.ca'  
**Cc:** 'Kozak, Mark'; Taylor, Andrew; jweir@suncor.com  
**Subject:** RE: Raptor Notification #4 (5th Raptor) - Adelaide Wind Project

Hello Jim,

This is a notification to inform you that an Osprey fatality was observed yesterday during our monthly raptor mortality monitoring program at the Suncor Energy Adelaide Wind Project. We have registered the fatality using the online Ontario database.

Details of the fatalities are provided below.

Date: June 21, 2015  
Location: Strathroy, ON  
Turbine: 9  
UTM: 17T 0449748 4763043  
Species: Osprey

If you have any questions, please don't hesitate to contact me.

**Melissa Straus, M.Sc.**

Terrestrial Ecologist  
Stantec  
70 Southgate Drive, Suite 1 Guelph ON N1G 4P5  
Phone: (519) 780-8103  
Cell: (226) 971-2704  
Fax: (519) 836-2493  
Melissa.Straus@stantec.com



**Celebrating 60 years of community, creativity, and client relationships.**

The content of this email is the confidential property of Stantec and should not be copied, modified, retransmitted, or used for any purpose except with Stantec's written authorization. If you are not the intended recipient, please delete all copies and notify us immediately.

 Please consider the environment before printing this email.



## **CONFIRMATION OF REGISTRATION**

Form Name: Notice of Possession

Date Registration Filed: 06/22/2015

Confirmation ID: M-101-6872634011

Version Number: 001

Update Date:

STANTEC CONSULTING LTD.

70 Southgate DR , SUITE 1  
Guelph, ON N1G4H5

Dear Sir/Madam,

You have registered under section 2 or 3.2 of Ontario Regulation 666/98 under the *Fish and Wildlife Conservation Act, 1997* and/or subsection 23.15(6) of Ontario Regulation 242/08 under the *Endangered Species Act, 2007*.

Your Notice of Possession form has been received by the Ministry of Natural Resources for the possession of the following:

Species Name: Osprey

Condition: Part

Number Acquired: 1

You may be required to show this record for certain activities.

Please refer to Ontario Regulations 666/98 and/or 242/08 for requirements that apply to your activity.

Any questions related to this registration and/or the Natural Resources Registry should be directed to:

Registry and Approval Services Centre  
Ministry of Natural Resources  
300 Water Street  
Peterborough, ON, K9J8M5  
Toll-free: 1-855-613-4256  
E-mail: [mnr.rasc@ontario.ca](mailto:mnr.rasc@ontario.ca)

NEW

---

---

**Part 1: Registrant Contact Information**

---

Legal/Business Name	Stantec Consulting Ltd.
Organization Type	
CRA Business No.	887251288

---



Part 1: Registrant Information

Contact Person

Last Name Kopysh		Middle Name Collette	
First Name Nicole		Name Suffix	Title MS
Primary Telephone No. (519)8366050	Ext. 263	Alternate Phone No.	Ext. Fax No.

E-mail Address  
nicole.kopysh@stantec.com

Mailing Address

Street No. 70	Street Name (include Street Type and Street Direction) Southgate DR		
City/Town/Municipality Guelph		Province/State ON	Postal/Zip Code N1G4H5
Unit Type SUITE	Unit Number 1	Delivery Type	Delivery #

Physical Civic Address

Street No. 70	Street Name (include Street Type and Street Direction) Southgate DR		
Unit Type SUITE		City/Town/Municipality Guelph	
Unit Number 1		Province/State ON	Postal/Zip Code N1G4H5

Physical Surveyed Address

Lot No.	Concession	Geographic Township
---------	------------	---------------------

Part Lot Description

Additional Location Information

---

**Part 2: Site Information**

---

Site Name

1. NAICS Code

2. NAICS Code

3. NAICS Code

Site Contact

Last Name

First Name

Telephone No.

Ext.

Alternate Phone

Ext.

Fax Number

Email

---

**Part 3: Activity Information**

---

**3.1 Registration Information**

This form is to be used to register:

- Possession of a carcass or part of a carcass for certain wildlife species regulated under the Fish and Wildlife Conservation Act and/or
- Possession of a dead species at risk regulated under the Endangered Species Act for the purpose of carrying out a scientific or educational activity.

You are only required to register the acquisition of certain species. For a list of species, please go [here](#).If you need help identifying the species, select [this link](#).

Please confirm that your circumstance meets the criteria in the Regulation(s) as described above and that you would like to proceed with registration:\*

 Yes  No

---

**3.2 Activity Related Information****3.2.1 Species Information**

- |                                  |        |
|----------------------------------|--------|
| a) Type of species               | Bird   |
| b) Species                       | Osprey |
| c) Condition of animal or plant: | Part   |

**3.2.2 Additional Information**

a) If the species has been previously registered, please enter the PRIOR Notice of Possession Confirmation ID (e.g. if it was transferred to you from someone else or if you misidentified the species in a previous registration):

b) Date of acquisition (mm/dd/yyyy)\* 06/21/2015

c) Number acquired\* 1

d) Circumstance of acquisition (If the species is a Species at Risk, then please select 'Other' and describe the education or scientific activity)\* Others

e) Specify 'other' circumstance\* Wind turbine fatality discovered during monthly raptor mortality monitoring program

f) Name of municipality and unorganized territory where it was acquired

g) Location details (e.g. closest roadway or intersection)

Newell Road and Egremont Drive,  
Strathroy Ontario; Turbine 9; 17T 449748  
4763043

Part 4 - Verification of Information

---

- I hereby declare that the information being provided through the Registry is complete and accurate, and I am aware that providing incomplete, false or misleading information shall result in the form being deemed to have not been submitted and this registration being invalid. I am aware that the activity I am registering for is subject to additional rules set out in regulation and I agree to follow those rules.

I, the undersigned, hereby declare that I have the authority to act on behalf of the corporation or other legal entity.

---

Last Name Kopysh	First Name Nicole
Company Name Stantec Consulting Ltd.	
Job Title Project Manager	Date (yyyy/mm/dd) 2015/06/22

---

---

**From:** Straus, Melissa  
**Sent:** Friday, August 28, 2015 1:21 PM  
**To:** 'Jim.beal@ontario.ca'  
**Cc:** 'Kozak, Mark'; Taylor, Andrew; [jweir@suncor.com](mailto:jweir@suncor.com); Corrigan, Anna; de Weerd, Craig  
**Subject:** RE: Notification #5 - Adelaide Wind Project, Little Brown Myotis

Hi Jim,

My apologies we had the wrong turbine number. Just wanted to follow up and correct the error we discovered during our quality review today.

The Little Brown Myotis was recovered at Turbine **21** (not 18). The remaining details regarding the fatality are correct, as detailed below. The bat has already been delivered to the University of Guelph.

Sincerely,

**Melissa Straus, M.Sc.**

Terrestrial Ecologist  
Stantec  
70 Southgate Drive, Suite 1 Guelph ON N1G 4P5  
Phone: (519) 780-8103  
Cell: (226) 971-2704  
Fax: (519) 836-2493  
[Melissa.Straus@stantec.com](mailto:Melissa.Straus@stantec.com)

**PLEASE NOTE I WILL BE ON VACATION SEPTEMBER 2 – 20<sup>TH</sup>.**



**Celebrating 60 years of community, creativity, and client relationships.**

The content of this email is the confidential property of Stantec and should not be copied, modified, retransmitted, or used for any purpose except with Stantec's written authorization. If you are not the intended recipient, please delete all copies and notify us immediately.

Please consider the environment before printing this email.

---

**From:** Straus, Melissa  
**Sent:** Wednesday, August 26, 2015 1:52 PM  
**To:** 'Jim.beal@ontario.ca'  
**Cc:** 'Kozak, Mark'; Taylor, Andrew; [jweir@suncor.com](mailto:jweir@suncor.com); Corrigan, Anna; de Weerd, Craig  
**Subject:** Notification #5 - Adelaide Wind Project, Little Brown Myotis

Hello Jim,

This is a notification to inform you that a Little Brown Myotis fatality was observed yesterday during our monthly Species at Risk (SAR) monitoring program at the Suncor Energy Adelaide Wind Project. This monitoring program is conducted in accordance with the **Mitigation Plan- Operation of Adelaide Wind Power Project** (Stantec, dated January 29, 2015) and as such we are implementing the mitigation measures as outlined in this document for an isolated impact for Little Brown Myotis.

We have registered the fatality using the online Ontario database.

Details of the fatality are provided below.

Date: August 25, 2015  
Location: Strathroy, ON  
Turbine: 18  
UTM: 17T 439155 4763541  
Species: Little Brown Myotis

We will send the bat to the Canadian Wildlife Health Cooperative (CWHC) at the University of Guelph for testing for White-nose Syndrome this week.

If you have any questions, please don't hesitate to contact me.

**Melissa Straus, M.Sc.**

Terrestrial Ecologist  
Stantec  
70 Southgate Drive, Suite 1 Guelph ON N1G 4P5  
Phone: (519) 780-8103  
Cell: (226) 971-2704  
Fax: (519) 836-2493  
Melissa.Straus@stantec.com



**Celebrating 60 years of community, creativity, and client relationships.**

The content of this email is the confidential property of Stantec and should not be copied, modified, retransmitted, or used for any purpose except with Stantec's written authorization. If you are not the intended recipient, please delete all copies and notify us immediately.

 Please consider the environment before printing this email.



## **CONFIRMATION OF REGISTRATION**

Form Name: Notice of Possession

Date Registration Filed: 08/26/2015

Confirmation ID: M-101-6100925599

Version Number: 001

Update Date:

STANTEC CONSULTING LTD.

70 Southgate DR , SUITE 1  
Guelph, ON N1G4H5

Dear Sir/Madam,

You have registered under section 2 or 3.2 of Ontario Regulation 666/98 under the *Fish and Wildlife Conservation Act, 1997* and/or subsection 23.15(6) of Ontario Regulation 242/08 under the *Endangered Species Act, 2007*.

Your Notice of Possession form has been received by the Ministry of Natural Resources for the possession of the following:

Species Name: Little Brown Myotis (Little Brown Bat)

Condition: Whole

Number Acquired: 1

You may be required to show this record for certain activities.

Please refer to Ontario Regulations 666/98 and/or 242/08 for requirements that apply to your activity.

Any questions related to this registration and/or the Natural Resources Registry should be directed to:

Registry and Approval Services Centre  
Ministry of Natural Resources  
300 Water Street  
Peterborough, ON, K9J8M5  
Toll-free: 1-855-613-4256  
E-mail: [mnr.rasc@ontario.ca](mailto:mnr.rasc@ontario.ca)

NEW

---

---

**Part 1: Registrant Contact Information**

---

Legal/Business Name	Stantec Consulting Ltd.
Organization Type	
CRA Business No.	887251288

---

Part 1: Registrant Information

Contact Person

Last Name Kopysh		Middle Name Collette	
First Name Nicole		Name Suffix	Title MS
Primary Telephone No. (519)8366050	Ext. 263	Alternate Phone No.	Ext. Fax No.

E-mail Address  
nicole.kopysh@stantec.com

Mailing Address

Street No. 70	Street Name (include Street Type and Street Direction) Southgate DR		
City/Town/Municipality Guelph		Province/State ON	Postal/Zip Code N1G4H5
Unit Type SUITE	Unit Number 1	Delivery Type	Delivery #

Physical Civic Address

Street No. 70	Street Name (include Street Type and Street Direction) Southgate DR		
Unit Type SUITE		City/Town/Municipality Guelph	
Unit Number 1		Province/State ON	Postal/Zip Code N1G4H5

Physical Surveyed Address

Lot No.	Concession	Geographic Township
---------	------------	---------------------

Part Lot Description

Additional Location Information



---

**Part 2: Site Information**

---

Site Name

1. NAICS Code

2. NAICS Code

3. NAICS Code

Site Contact

Last Name

First Name

Telephone No.

Ext.

Alternate Phone

Ext.

Fax Number

Email

---

**Part 3: Activity Information**

---

**3.1 Registration Information**

This form is to be used to register:

- Possession of a carcass or part of a carcass for certain wildlife species regulated under the Fish and Wildlife Conservation Act and/or
- Possession of a dead species at risk regulated under the Endangered Species Act for the purpose of carrying out a scientific or educational activity.

You are only required to register the acquisition of certain species. For a list of species, please go [here](#).If you need help identifying the species, select [this link](#).

Please confirm that your circumstance meets the criteria in the Regulation(s) as described above and that you would like to proceed with registration:\*

 Yes  No

---

**3.2 Activity Related Information****3.2.1 Species Information**

a) Type of species

Mammal

b) Species

Little Brown Myotis (Little Brown Bat)

c) Condition of animal or plant:

Whole

**3.2.2 Additional Information**

a) If the species has been previously registered, please enter the PRIOR Notice of Possession Confirmation ID (e.g. if it was transferred to you from someone else or if you misidentified the species in a previous registration):

b) Date of acquisition (mm/dd/yyyy)\*

08/25/2015

c) Number acquired\*

1

d) Circumstance of acquisition (If the species is a Species at Risk, then please select 'Other' and describe the education or scientific activity)\*

Others

e) Specify 'other' circumstance\*

Turbine mortality at the Adelaide Wind Farm

f) Name of municipality and unorganized territory where it was acquired

ADELAIDE (GEOGRAPHIC TOWNSHIP)

g) Location details (e.g. closest roadway or intersection)

Turbine 18, Intersection: Crathie Drive and Seed Road, UTM: 17T 0439155E, 4763541N

Part 4 - Verification of Information

---

I hereby declare that the information being provided through the Registry is complete and accurate, and I am aware that providing incomplete, false or misleading information shall result in the form being deemed to have not been submitted and this registration being invalid. I am aware that the activity I am registering for is subject to additional rules set out in regulation and I agree to follow those rules.

I, the undersigned, hereby declare that I have the authority to act on behalf of the corporation or other legal entity.

---

Last Name Kopysh	First Name Nicole
Company Name Stantec Consulting Ltd.	
Job Title Project Manager	Date (yyyy/mm/dd) 2015/08/26

---

# APPENDIX I: RAPTOR MONITORING PROTOCOL

**Adelaide Wind Power Project:  
Raptor Monitoring Plan**



Prepared for:  
Suncor Adelaide Wind Limited  
Partnership  
150 6<sup>th</sup> Avenue SW  
Calgary, AB T2P 3E3

Prepared by:  
Stantec Consulting Ltd.  
70 Southgate Drive, Suite 1  
Guelph ON N1E 7B8

File No. 160961067  
February 9, 2017

## Sign-off Sheet

This document entitled Adelaide Wind Power Project: Raptor Monitoring Plan was prepared by Stantec Consulting Ltd. ("Stantec") for the account of Suncor Energy Products Inc. (the "Client"). Any reliance on this document by any third party is strictly prohibited. The material in it reflects Stantec's professional judgment in light of the scope, schedule and other limitations stated in the document and in the contract between Stantec and the Client. The opinions in the document are based on conditions and information existing at the time the document was published and do not take into account any subsequent changes. In preparing the document, Stantec did not verify information supplied to it by others. Any use which a third party makes of this document is the responsibility of such third party. Such third party agrees that Stantec shall not be responsible for costs or damages of any kind, if any, suffered by it or any other third party as a result of decisions made or actions taken based on this document.

Prepared by                     *Melissa Straus*                      
(signature)

**Melissa Straus, M.Sc.**  
Terrestrial Ecologist

Reviewed by                     *Andrew Taylor*                      
(signature)

**Andrew Taylor, B.Sc.**  
Senior Ecologist

Reviewed by                     *N. Kopysh*                      
(signature)

**Nicole Kopysh, B.E.S**  
Project Manager

## Table of Contents

<b>ABBREVIATIONS</b> .....	<b>1</b>
<b>1.0 INTRODUCTION</b> .....	<b>1.1</b>
<b>2.0 RAPTOR BACKGROUND</b> .....	<b>2.1</b>
2.1 ADELAIDE 2015.....	2.1
2.2 RAPTOR BEHAVIOR .....	2.2
<b>3.0 METHODS</b> .....	<b>3.1</b>
3.1 SCOPED MORTALITY MONITORING.....	3.1
3.2 CAUSE AND EFFECT MONITORING.....	3.1
3.2.1 Background Review .....	3.2
3.2.2 Habitat Mapping .....	3.2
3.2.3 Behavioural Surveys.....	3.4
3.3 RESPONSE TO A MORTALITY .....	3.4
<b>4.0 REPORTING AND ANALYSIS</b> .....	<b>4.1</b>
<b>5.0 SUMMARY</b> .....	<b>5.1</b>
<b>6.0 REFERENCES</b> .....	<b>6.1</b>

### LIST OF TABLES

Table 1: Species-specific Habitat Mapping at the Adelaide Wind Power Project.....	3.3
---	-----

### LIST OF APPENDICES

#### APPENDIX A: FIGURES

Figure 1: Adelaide Project Boundary

Figure 2: Adelaide Supplemental Raptor Study Area

## Abbreviations

EEMP	Environmental Effects Monitoring Plan
KV	Kilovolt
MNR(F)	Ministry of Natural Resources (and Forestry)
MW	Megawatt
NHA/EIS	Natural Heritage Assessment
REA	Renewable Energy Approval

# ADELAIDE WIND POWER PROJECT: RAPTOR MONITORING PLAN

Introduction  
February 9, 2017

## 1.0 INTRODUCTION

Suncor Adelaide Wind Limited Partnership (Suncor) is operating the 18 turbine Adelaide Wind Power Project (Adelaide) north of Strathroy, Ontario, in Middlesex County, Municipality of Adelaide Metcalfe. The Project is located north of Strathroy, Ontario, bound by Sexton Road to the west, Townsend Line and Wardell Road to the North, Hansford Road to the east, and Highway 402 to the south (**Figure 1, Appendix A**).

The Renewable Energy Approval (REA) for Adelaide was issued on December 11, 2013 under the *Environmental Protection Act* section 47.3(1) (REA No. 8279-9AUP2B). Section I of the REA details the wildlife post-construction monitoring program for the facility, including reporting requirements and applicable performance measures (i.e. mortality thresholds) based on the results and recommendations presented in the Natural Heritage Assessment and Environmental Impact Study (NHA/EIS), associated addenda (Stantec 2012a, 2012b, 2013a, 2013b) and Environmental Effects Monitoring Plan for Wildlife and Wildlife Habitat (EEMP; Stantec 2012c).

The Adelaide Wind Power Project began operation in 2015, which included the first year of post-construction monitoring for both mortality and disturbance studies.

Post-construction mortality monitoring was conducted for bats, birds and raptors (i.e., members of the family Pandionidae [Osprey, *Pandion haliaetus*], Accipitridae [hawks and eagles], Falconidae [falcons], and Cathartidae [vultures]) using standard methodologies for mortality surveys, in accordance with *Birds and Bird Habitats: Guidelines for Wind Power Projects* (MNR 2011) and detailed in the EEMP.

During the first year of monitoring, two Turkey Vultures (*Cathartes aura*), two Red-tailed Hawk (*Buteo jamaicensis*) fatalities were recovered. Correcting for percent area searched, as searcher efficiency and scavenger rates are assumed to be 1.0 for large-bodied birds, these 4 fatalities resulted in a mortality rate of 0.46 raptors/turbine/year. One additional raptor, an Osprey, was recovered during the supplemental monthly monitoring program.

The raptor mortality rate recorded in 2015 of 0.46 raptors/turbine/year was above the provincial threshold of 0.2 raptors/turbine/year (MNR 2011). As such, in accordance with the EEMP and the REA, the following steps are required;

- Two years of subsequent scoped mortality and cause and effect monitoring for raptors (starting in 2016).
- Following the scoped monitoring, implementation of operational mitigation for the life of the facility.
- Effectiveness monitoring at individual turbines for three years, following implementation of mitigation.



## ADELAIDE WIND POWER PROJECT: RAPTOR MONITORING PLAN

Introduction  
February 9, 2017

Based on the data collected to date, the Adelaide Wind Power Project does not appear to have any unique risk factors that would explain the elevated mortality rates observed in 2015. Furthermore, there were a number of unusual circumstances surrounded the raptor fatalities recovered (discussed in **Section 2.1**). The reason for these unusual findings at the Adelaide Wind Power Project is not clear. However, the monitoring program provided within this Raptor Monitoring Plan is designed to provide additional information to further assess impacts to raptors and inform protocols for operational mitigation.

This Raptor Monitoring Plan provides the methods and reporting protocols for the scoped mortality and cause and effect monitoring that is required by the EEMP and REA. The implementation of this Plan will fulfill the requirements for the additional scoped monitoring as a result of the raptor threshold exceedance in 2015.

## ADELAIDE WIND POWER PROJECT: RAPTOR MONITORING PLAN

Raptor Background  
February 9, 2017

### 2.0 RAPTOR BACKGROUND

Results of the 2015 mortality monitoring program are discussed below, as are behavioral habits of the three species recovered in 2015, Turkey Vulture, Red-tailed Hawk, and Osprey, both used to inform the creation of this monitoring plan.

#### 2.1 ADELAIDE 2015

A total of five raptor mortalities were reported during the first year of mortality monitoring at Adelaide in 2015. This included two Red-tailed Hawks and two Turkey Vultures recovered during the regular monitoring program as well as one additional fatality, an Osprey, recovered during the monthly supplemental monitoring. All species are common in Ontario, ranked S5 (Common, widespread, and abundant in the province).

Red-tailed Hawks and Turkey Vultures are the two more commonly encountered raptor fatalities at Ontario wind facilities (3.99 % and 2.29 %, respectively; BSC et al. 2014). Osprey is rarely recovered, ranked 109<sup>th</sup> of recovered species in Ontario, comprising 0.19 % of all turbine fatalities in the province (BSC et al. 2014).

Seasonal variability in mortality rates is typically attributed to periods where large numbers of migrating birds (including raptors) move through the province while travelling between their breeding and wintering grounds. Increases have been recorded most strongly during the fall migration period (August to October) which exhibits the majority of all bird fatalities (Environment Canada et al. 2011, Erickson et al. 2014, BSC et al., 2014). In this regard, the recorded raptor fatalities at the Adelaide project were very unusual. The timing of all five raptor fatalities corresponds with the nesting season (Turkey Vulture and Osprey, Cadman et al. 2007; Red-tailed Hawk, Preston and Beane 2009), with no fatalities recorded during spring or fall migration; a time when raptor fatalities are mostly likely to occur. Furthermore, all five fatalities occurred during a very short, eleven day period (June 11 to June 21), with both Turkey Vultures fatalities occurring on the same day at the same turbine. Finding two bird fatalities at a single turbine during a single monitoring event is rare, being reported only a handful of times in Ontario (Friesen 2011), and finding two raptors at the same turbine during the same monitoring event is even rarer (Stantec, unpublished data). It is particularly unusual this would occur during the breeding season when raptor mortality is typically very low. The reason for these unusual findings at the Adelaide Wind Power Project is not clear.

Red-tailed Hawks were not recorded nesting within the zone of investigation (i.e. 120 m from the Project Location) during the pre-construction surveys conducted in 2010 (Golder) and 2011 and 2012 (Stantec); however, this is a common breeding species in agricultural settings and may have been nesting in the local landscape in 2015. The species typically nests in woodland habitat; potential nesting habitat is present in the scattered woodlots in the local landscape. Likewise, the Turkey Vulture is a common species in agricultural settings. It naturally nests in sites such as caves, rocky cliffs or hollow trees, but in agricultural settings regularly nests in buildings,



## ADELAIDE WIND POWER PROJECT: RAPTOR MONITORING PLAN

Raptor Background  
February 9, 2017

such as abandoned barns. Nesting sites in buildings may also occur within the local landscape. Both species were likely present in the local landscape during the breeding season, as both are documented as nesting within the 10 x 10 km Breeding Bird Atlas square that overlaps with the Project Boundary (Cadman et al. 2007); however, the same would be true for most wind farms in southern Ontario and not unique to the Adelaide Wind Power Project. Although the presence of suitable breeding habitat does not appear to explain the unusual mortality during the nesting season at this project in 2015, the association between nesting location and risk is currently unknown.

Unlike the other two species, Osprey is unlikely to be nesting in the local landscape. This species feeds almost exclusively on fish (Poole et al. 2002) and are therefore associated with aquatic habitats for both foraging and nesting. Osprey build nests in trees, utility poles or other structures near or over open water including lakes and rivers (Cadman et al. 2007). No Osprey nests are known to occur in the vicinity of the Project (Stantec 2012b). Osprey were also not recorded as nesting within the 10 x 10 km Breeding Bird Atlas squares that overlaps with the Adelaide Project Boundary (Cadman et al. 2007). Suitable aquatic habitat (i.e. lakes or rivers) do not occur in the local landscape (**Figure 1, Appendix A**). The closest potential Osprey habitat for nesting and foraging exists along the large watercourses to the south in Strathroy (impoundments of the Sydenham River approximately 5 kilometers from closest turbine) and north of the facility (Ausable River approximately 3 kilometers from closest turbine).

The timing (i.e., breeding season, 11 day period), species (Osprey), and pattern of recovery (2 at one turbine) of the mortalities recovered in 2015 at the Adelaide facility are highly unusual.

## 2.2 RAPTOR BEHAVIOR

In considering the unusual raptor fatality results recovered at the Adelaide facility in 2015, this raptor monitoring plan was devised to better understand any potential links between habitat use and risk of turbine strike. Despite the two Turkey Vultures recovered at the same turbine (turbine 27) in 2015, there was no apparent spatial pattern to the recovered fatalities. For this reason, in developing the monitoring plan, we included all turbines in the program and not only those where raptors were recovered in 2015. This is also appropriate as raptor fatality rates exhibit high inter-annual variation (Smallwood, 2013).

The average home range size for Red-tailed Hawks is 1.16 km<sup>2</sup> (Preston and Beane 2008). Home range size for Turkey Vultures and Osprey are very large, with Turkey Vultures typically spending their days within 10 km of communal roosts (Kirk and Mossman 1998) and Ospreys conducting 14 km hunting forays from the nest (Poole et al 2002). Considering this variability, 1 km was determined to be an appropriate study area from each turbine, noting that an excessively large area may not provide useful information.

## ADELAIDE WIND POWER PROJECT: RAPTOR MONITORING PLAN

Raptor Background  
February 9, 2017

Although it is uncertain which (if any) of the recovered fatalities were breeding, breeding individuals caring for nestlings exhibit foraging habits different from non-breeding individuals. Foraging behavior has been associated with higher risk of mortality at wind facilities, particularly for Turkey Vultures and Red-tailed Hawks (Garvin et al. 2011). In consideration of the timing of the 2015 recovered fatalities, the identification of nest and nest habitat in 2016 may assist in determining if nest proximity to turbines is a risk factor for these species.

In consideration of the 2015 results and the known behavior of the three recovered species, the scoped mortality and cause and effects monitoring methods detailed below have been developed to further assess the risk to breeding Red-tailed Hawks, Turkey Vultures and Osprey ("the Species").

Methods  
February 9, 2017

### 3.0 METHODS

The scoped mortality and cause and effect monitoring program will be conducted in 2016 and 2017 to provide additional information on raptor habitat use and mortality of raptors associated with the Adelaide facility. This will be used to better inform and assist in establishing any proposed mitigation measures.

The results of the 2015 mortality monitoring program (e.g., species and timing of mortalities) were used to guide the development of the scoped mortality and cause and effect monitoring programs. Survey methods are described below.

#### 3.1 SCOPED MORTALITY MONITORING

In accordance with the requirements of the REA for the Project, mortality monitoring is being undertaken at the Adelaide Wind Project as detailed in the EEMP. The EEMP monitoring consists of bi-weekly searches at a subset of 10 turbines (May-October; **Figure 1, Appendix A**) with monthly surveys at the 8 non-subset turbines (May-November) and weekly monitoring during the month of November at the turbine subset. This program will be conducted in 2016 and 2017.

In addition to the EEMP monitoring, additional scoped monitoring will be undertaken to further assess impacts to the Species during the nesting season. Scoped mortality monitoring will consist of searches within 50 m of all non-subset turbines by walking in concentric circles. The frequency of the monthly non-subset surveys monitoring will be increased to once per week during the nesting season for the Species (May, June and July).

Because the scoped mortality monitoring is not intended to provide an estimate of mortality, but rather to help identify risk factors and inform mitigation measures, the results will not be included in the calculation of thresholds. However, scavenger trials for raptors will be undertaken to determine what level, if any, of removal of raptor carcasses is occurring. Depending on availability of raptor carcasses in suitable condition, up to three will be used each year in the scavenger trials. The total number, species, and timing of all raptor mortalities recorded during the EEMP and the supplemental scoped monitoring programs will be analyzed and used to assess impacts to raptors and inform protocols for operational mitigation.

#### 3.2 CAUSE AND EFFECT MONITORING

The cause and effect monitoring will consist of two components:

- background review
- mapping foraging and nesting habitat within 1 km of turbines

## ADELAIDE WIND POWER PROJECT: RAPTOR MONITORING PLAN

Methods

February 9, 2017

The objective of the cause and effects monitoring will be to determine if there are nesting or foraging habitat features present that may be increasing the risk of mortality for the Species. This information can be helpful in further assessing risk and informing mitigation. Identifying potential concentration areas and preferred habitat around operational turbines will assist in assessing any existing cause and effect relationships. Habitats will be mapped to the level of detail possible.

### 3.2.1 Background Review

A review of available background information will be undertaken in spring 2016 in order to identify any previously unknown or new nesting occurrences that have been documented within the Project Boundary (**Figure 1, Appendix A**) for the Species since the preconstruction surveys were completed. Review sources may include, but not be limited to: eBird, NatureServe, the local Field Naturalists Club, and Land Information Ontario data.

All records of nesting habitat obtained during the records review will be mapped in relation to the Adelaide facility. All locations of Osprey nests and any Red-tailed Hawk or Turkey Vulture nests that occur within 1 km of a turbine location will be visited as part of the habitat mapping below.

The background review will be completed in spring, 2016, prior to the initiation of the habitat mapping surveys.

### 3.2.2 Habitat Mapping

Habitat mapping conducted in 2016 and 2017 will target areas within a 1 km radius of each turbine as shown in **Figure 2 (Appendix A)**. This distance is based on the average home range size for Red-tailed Hawks, as discussed in **Section 1.0**. Two visits per year, once in April and once in May or June, will be conducted by driving all municipal and access roads within the 1 km Study Area and mapping suitable habitat. Two types of habitats, as well as any species observed, will be identified during the surveys. This will include:

1. Nesting habitat identified (and include methods as per 3.2.2.1)
2. Foraging habitat will be identified (as per 3.2.2.2)
3. Any observations of the Species will be recorded (as per 3.2.2.3)

Habitat types will be mapped according to nesting and foraging requirements for the three species of raptors recovered in 2015 (**Table 1**).

## ADELAIDE WIND POWER PROJECT: RAPTOR MONITORING PLAN

Methods  
February 9, 2017

**Table 1: Species-specific Habitat Mapping at the Adelaide Wind Power Project**

Species	Habitat Component	Habitat Component to Map	Documented Habitat Use
Turkey Vulture	Nesting	Accessible barns and abandoned buildings	Entry/exit to building
	Foraging	Carrion	Congregation of vultures, evidence of direct feeding
Red-tailed Hawk	Nesting	Potential nest sites (bulky stick nests)	Flying to/from nest, pair observed in vicinity of nest
	Foraging	Grasslands, meadows	Observation of flying overhead or perched
Osprey	Nesting	Potential nest sites (bulky stick nest on platform)	Flying to/from nest, pair observed in vicinity of nest
	Foraging	Large streams or rivers	Observation of flying or perched over suitable aquatic habitat
Other raptor species	Nesting	Potential nest sites	Flying to/from nest, pair observed in vicinity of nest

### 3.2.2.1 Nesting Habitat

The timing of the April survey date is expected to coincide with optimal forest visibility conditions prior to leaf-out, conducive to Red-tailed Hawk nest searches. The early survey date in 2016 will also be used to identify the location of any raptor nests that occurred within the Study Area in 2015, as both Red-tailed Hawk and Osprey nests (discussed above) persist throughout the winter. The later survey is timed to coincide with the nesting period of the Species when activity levels at the nest are highest and nestlings may be visible.

Each 1 km zone will be visited by a qualified ecologist. The occurrence of any nesting features as identified in Table 1 will be mapped. Nests will be assessed on each visit for activity using binoculars or a spotting scope. The location of all raptor nests will be mapped, regardless of activity level. The presence of adults and/or nestlings at the nest will be recorded (if applicable).

The Study Area (i.e., 1 km area surrounding all turbines) will be surveyed again to record any new nests during the second survey. Methods will replicate those used in the first survey (municipal and access roads, binoculars, and scopes).

Nesting habitat surveys will be conducted in each of 2016 and 2017.

### 3.2.2.2 Foraging Habitat

Foraging habitat features (as described in Table 1) will be mapped during both the April and May or June survey dates on an air photo, including any incidental observations of use (as described below).



## ADELAIDE WIND POWER PROJECT: RAPTOR MONITORING PLAN

Methods

February 9, 2017

### 3.2.2.3 Incidental Observations

On each survey, all observations of Turkey Vultures, Osprey, and Red-tailed Hawks will be recorded. The location of each observation will be mapped on an air photo. Species, number of individuals, behavior (e.g., soaring, direct passage, perched) and flight heights (at turbine height, above, or below) will be recorded.

### 3.2.3 Behavioural Surveys

Behaviour surveys will be conducted weekly in May, June and July. During each survey active nests will be monitored for 2 hours from a stationary survey location, using a spotting scope. Weather conditions, survey date, time (and duration) and field personnel will be recorded on each visit. Notes will be made on the activity of the nest and observations of raptor movements and behaviour. Each behaviour observed (and duration of time spent per behaviour) and flight heights will be recorded. Each flight path observed and any perches used will be identified and mapped in relation to turbine locations.

The results of the surveys will be used to identify raptor behavior in proximity to wind turbines including flight patterns, flight heights and identify perching and foraging habitat.

## 3.3 RESPONSE TO A MORTALITY

In the event that a Species mortality is identified at a turbine in either 2016 or 2017 during the breeding season (e.g., April-August), and the results of the habitat mapping conducted in **Section 3.2.2.1** identifies a nest of that species within 1 km, a follow-up nest check will be conducted. The purpose of this follow-up visit is to determine if the observed mortality is an individual from the nearby nest or an unrelated individual.



## ADELAIDE WIND POWER PROJECT: RAPTOR MONITORING PLAN

Reporting and Analysis  
February 9, 2017

### 4.0 REPORTING AND ANALYSIS

Reporting for the scoped raptor mortality and cause and effect monitoring programs will occur annually in conjunction with the EEMP post-construction monitoring report.

Analysis of the cause and effect monitoring in 2016 will examine spatial patterns of 2015 and 2016 raptor fatalities relative to identified nest locations (active, as well as inactive in 2016), and foraging habitat.

The 2017 report will synthesize the two years' of data and compare inter-annual variation in habitat availability, nest locations, and mortality patterns. The analysis in this report will be used to inform recommendations on measures to mitigate any documented risk to raptors within the Adelaide Wind Power Project.

## ADELAIDE WIND POWER PROJECT: RAPTOR MONITORING PLAN

Summary  
February 9, 2017

### 5.0 SUMMARY

2015 was the first year of operation and post-construction monitoring at the Adelaide Wind Power Project. The recovery of two Turkey Vultures and two Red-tailed Hawk fatalities during the month of June resulted in a calculated raptor mortality rate of 0.46, which exceeded the 0.20 raptors/turbine/year threshold. One additional raptor fatality, an Osprey, was recovered during the supplemental monthly mortality monitoring in 2015.

In accordance with the EEMP and REA Section 18, two years of subsequent scoped mortality and cause and effect monitoring for raptors will commence in 2016. This Raptor Monitoring Plan provides the methods and reporting protocols for the scoped mortality and cause and effect monitoring that is required by the EEMP and REA. The implementation of this Plan will fulfill the requirements for the additional scoped monitoring as a result of the raptor threshold exceedance in 2015.

## ADELAIDE WIND POWER PROJECT: RAPTOR MONITORING PLAN

References  
February 9, 2017

### 6.0 REFERENCES

- Cadman, M. D., D.A. Sutherland, G.G. Beck, D. Lepage, A.R. Couturier. 2007. Atlas of the Breeding Birds of Ontario, 2001-2005. (eds) Bird Studies Canada, Environment Canada, Ontario Field Ornithologists, Ontario Ministry of natural resources, and Ontario Nature, Toronto, xxii + 318pp.
- Environment Canada, the Canadian Wind Energy Association and the Ontario Ministry of Natural Resources. 2011. Wind Energy Bird and Bat Monitoring Database Summary of the Findings from Post-construction Monitoring Reports. November 2011. 17pp.
- Erickson, W., K. Kronner and B. Gritski. 2003. Nine Canyon Wind Power Project Avian And Bat Monitoring Report: September 2002 – August 2003. Prepared For: Nine Canyon Technical Advisory Committee. October 2003.
- Kikuchi, R. 2008. Adverse impacts of wind power generation on collision behaviour of birds and anti-predator behaviour of squirrels. *Journal for Nature Conservation (Jena)*, 16, 44–55.
- Ontario Ministry of Natural Resources (MNR). 2011. Birds and Bird Habitats. Guidelines for Wind Power Projects. 32 pp. December 2011.
- Poole, A., R. Bierregaard, M. Martell. 2002. Osprey (*Pandion haliaetus*). A Poole, F Gill, eds. *The Birds of North America*, Vol. 683. Philadelphia, PA: The Birds of North America, Inc.
- Preston, C. R. and R. D. Beane. 2009. Red-tailed Hawk (*Buteo jamaicensis*), *The Birds of North America Online* (A. Poole, Ed.). Ithaca: Cornell Lab of Ornithology; Retrieved from the *Birds of North America Online*: <http://bna.birds.cornell.edu/bna/species/052>
- Stantec Consulting Ltd. 2012a. Suncor Energy Adelaide Wind Energy Project Natural Heritage Assessment & Environmental Impact Study. July 2012.
- Stantec Consulting Ltd. 2012b. Suncor Energy Adelaide Wind Energy Project Environmental Effects Monitoring Plan For Wildlife (EEMP). July 2012.
- Stantec Consulting Ltd. 2012c. Suncor Energy Adelaide Wind Project Addendum I. October 2012.
- Stantec Consulting Ltd. 2013a. Suncor Energy Adelaide Minor Modifications. February 2013.
- Stantec Consulting Ltd. 2013b. Suncor Energy Adelaide Project Modifications. November 2013.
- Stantec Consulting Ltd. 2016. Adelaide Wind Power Project: Post-Construction Wildlife Monitoring Report (2015).

# APPENDIX A: FIGURES

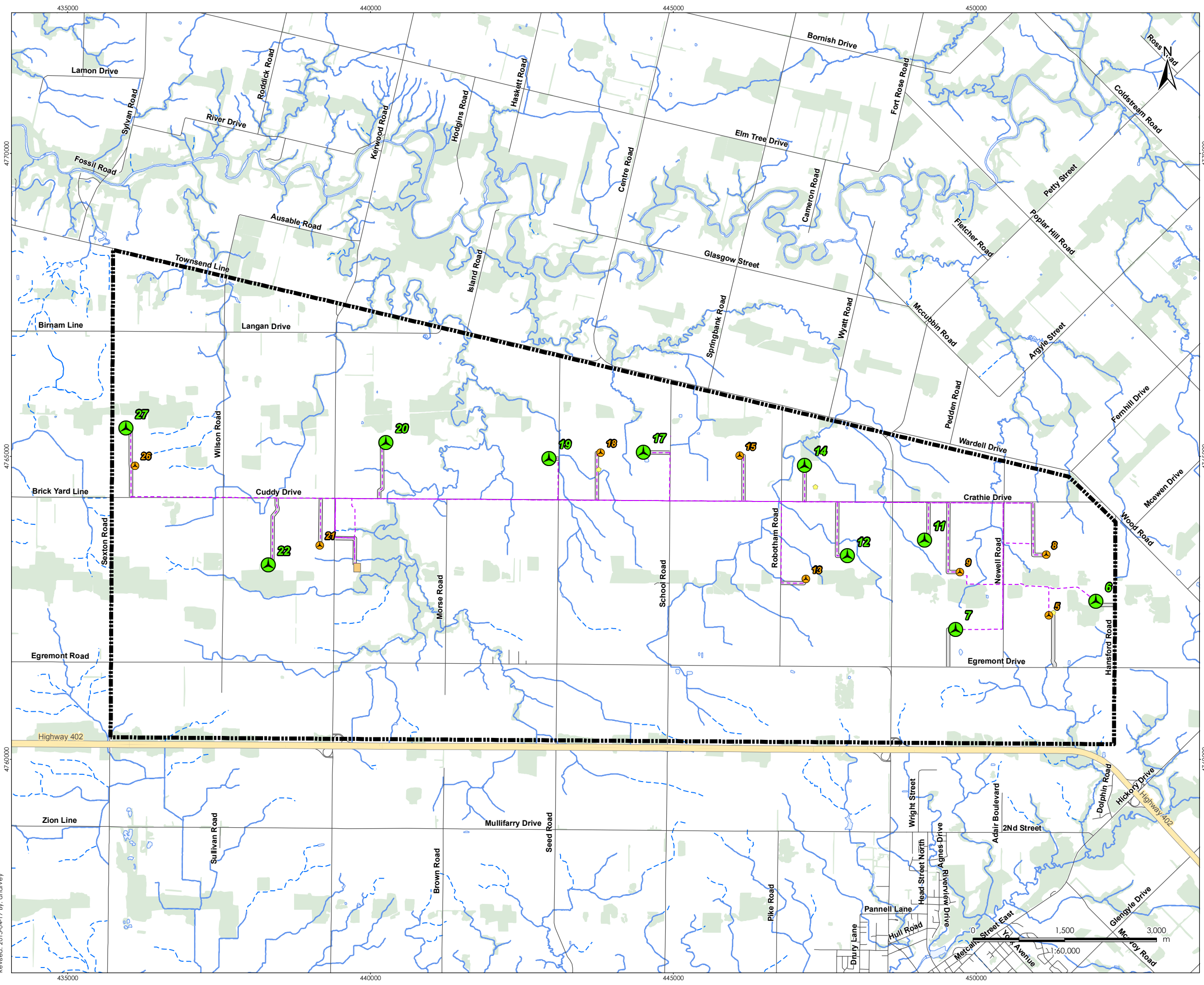

**Legend**

- Project Boundary
- Turbine Subset

**Project Components**

- MET Tower
- Turbine Location
- Access Road
- Collector Line
- Substation Constructible Area

**Existing Features**

- Expressway / Highway
- Road
- Watercourse
- Constructed Drain
- Waterbody

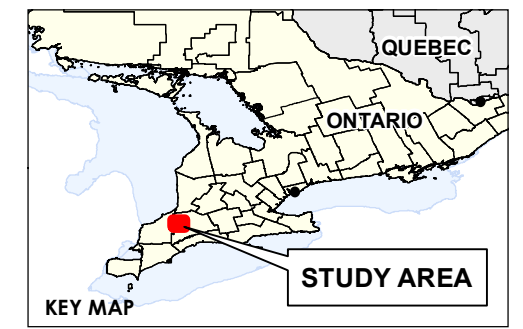

- Notes**
- Coordinate System: NAD 1983 UTM Zone 17N
  - Base features produced under license with the Ontario Ministry of Natural Resources © Queen's Printer for Ontario, 2013.

Client/Project

Suncor Energy  
Adelaide Wind Project

Figure No.  
**1**

Title  
**Post-construction Monitoring  
EEMP Turbine Subset**

W:\Active\60960710\drawing\MXD\Terrestrial\Post\_Con\_Monitoring\EEMP\_TurbineSubset\_20150417.mxd  
 Revised: 2015-04-17 By: dharvey

April 2015  
160960710



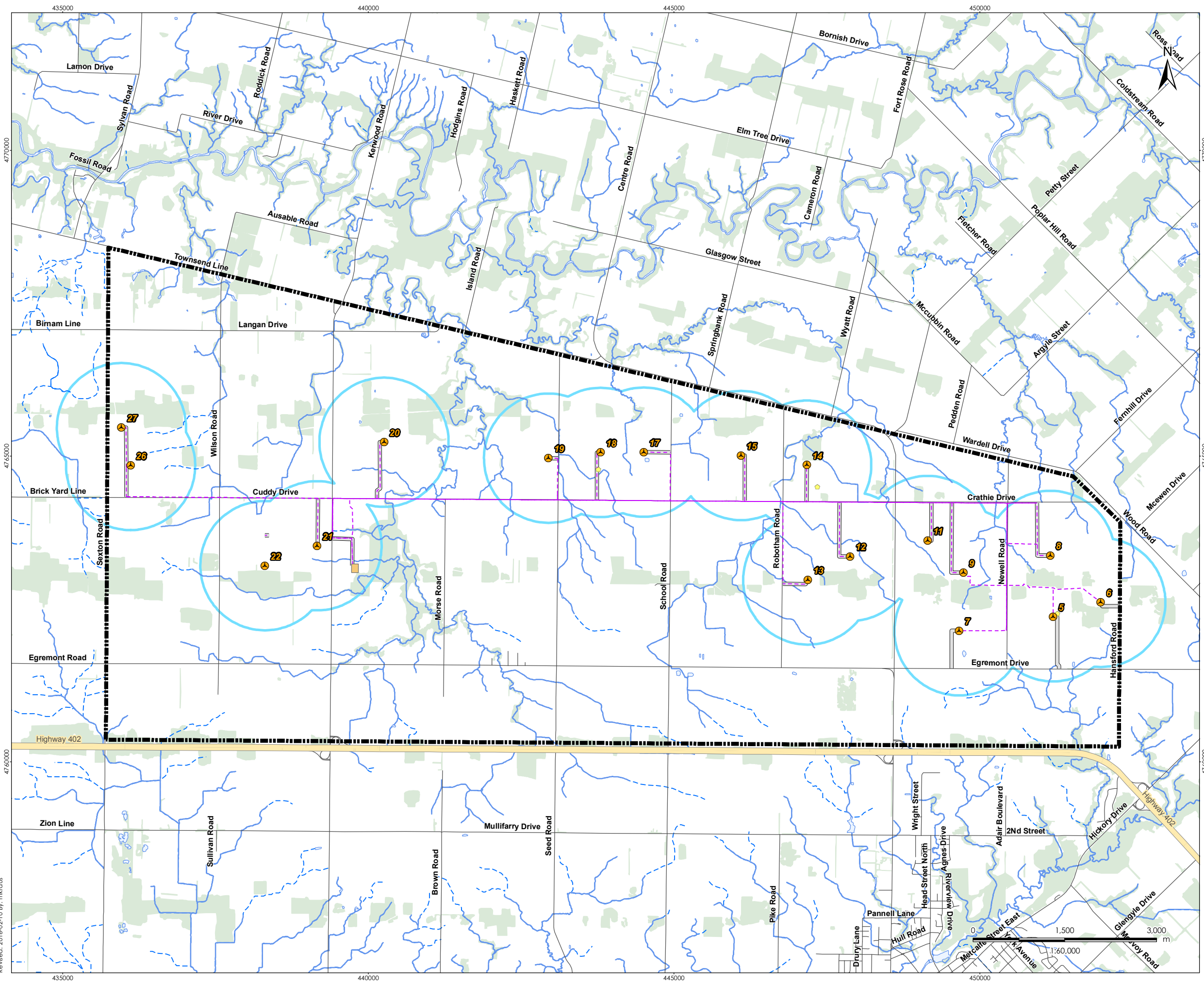

**Legend**

- Project Boundary
- Raptor Study Area
- Project Components**
- MET Tower
- Turbine Location
- Access Road
- Collector Line
- Substation Constructible Area
- Existing Features**
- Expressway / Highway
- Road
- Watercourse
- Constructed Drain
- Waterbody



- Notes**
1. Coordinate System: NAD 1983 UTM Zone 17N
  2. Base features produced under license with the Ontario Ministry of Natural Resources © Queen's Printer for Ontario, 2013.

February 2016  
160960710

Client/Project  
Suncor Energy  
Adelaide Wind Project

Figure No.  
**2**

Title  
**Supplemental Raptor  
Study Area (2016-2017)**

W:\Active\60960710\drawing\MXD\Territorial\Post\_Con\_Monitoring\2015\160960710\_Post\_Con\_Monitoring\_SupplementalRaptorsStudyArea\_20150210.mxd  
 Revised: 2016-02-10 By: mkrcaus

